

CNC

8055 .T.

Operating manual

Ref. 1110
Soft: V01.3x



FAGOR AUTOMATION



All rights reserved. No part of this documentation may be transmitted, transcribed, stored in a backup device or translated into another language without Fagor Automation's consent. Unauthorized copying or distributing of this software is prohibited.

The information described in this manual may be changed due to technical modifications. Fagor Automation reserves the right to make any changes to the contents of this manual without prior notice.

All the trade marks appearing in the manual belong to the corresponding owners. The use of these marks by third parties for their own purpose could violate the rights of the owners.

It is possible that CNC can execute more functions than those described in its associated documentation; however, Fagor Automation does not guarantee the validity of those applications. Therefore, except under the express permission from Fagor Automation, any CNC application that is not described in the documentation must be considered as "impossible". In any case, Fagor Automation shall not be held responsible for any personal injuries or physical damage caused or suffered by the CNC if it is used in any way other than as explained in the related documentation.

The content of this manual and its validity for the product described here has been verified. Even so, involuntary errors are possible, thus no absolute match is guaranteed. Anyway, the contents of the manual is periodically checked making and including the necessary corrections in a future edition. We appreciate your suggestions for improvement.

The examples described in this manual are for learning purposes. Before using them in industrial applications, they must be properly adapted making sure that the safety regulations are fully met.

This product uses the following source code, subject to the terms of the GPL license. The applications *busybox* V0.60.2; *dosfstools* V2.9; *linux-ftpd* V0.17; *ppp* V2.4.0; *uteln* V0.1.1. The library *grx* V2.4.4. The linux kernel V2.4.4. The linux boot *ppcboot* V1.1.3. If you would like to have a CD copy of this source code sent to you, send 10 Euros to Fagor Automation for shipping and handling.

INDEX

About the product	7
Declaration of conformity	9
Version history	11
Safety conditions	13
Warranty terms	17
Material returning terms	19
Additional remarks	21
Fagor documentation.....	23
CHAPTER 1	GENERAL CONCEPTS
<hr/>	
1.1 Part programs	26
1.2 Monitor information layout.....	28
1.3 Keyboard layout	30
1.3.1 The EDIT, SIMUL and EXEC keys.....	31
1.4 Layout of the operator panel.....	33
CHAPTER 2	OPERATING MODES
<hr/>	
2.1 Help systems	36
2.2 Software update.....	38
2.3 KeyCF (KeyCompactFlash)	39
2.3.1 Directory structure.....	40
CHAPTER 3	OPERATIONS VIA ETHERNET
<hr/>	
3.1 Remote hard disk.....	44
3.2 Connection to a PC through WinDNC.....	45
3.3 Access the CNC's hard disk from a PC	46
CHAPTER 4	EXECUTE / SIMULATE
<hr/>	
4.1 Block search. Switching from simulation to execution	52
4.1.1 Operating modes.....	53
4.1.2 Automatic block search	55
4.1.3 Manual block search	56
4.1.4 Home searching restrictions.....	58
4.1.5 Disabling the simulation and block search modes	58
4.2 Display	59
4.2.1 Standard display mode	60
4.2.2 Position display mode	61
4.2.3 Part-program display.....	61
4.2.4 Subroutine display mode.....	62
4.2.5 Following error display mode	64
4.2.6 User display mode	64
4.2.7 Execution time display mode	65
4.3 MDI	66
4.4 Tool inspection.....	67
4.5 Graphics.....	70
4.5.1 Type of graphic	71
4.5.2 Display area	73
4.5.3 Zoom.....	74
4.5.4 Graphic parameters	75
4.5.5 Clear screen.....	77
4.5.6 Deactivate graphics.....	78
4.5.7 Measurement	79
4.6 Single block.....	80
CHAPTER 5	EDIT
<hr/>	
5.1 Edit.....	82
5.1.1 Editing in CNC language.....	83
5.1.2 TEACH-IN editing.....	84
5.1.3 Interactive editor.....	85
5.1.4 Profile editor.....	86



CNC 8055
CNC 8055i

-T- MODEL
SOFT: V01.3x

5.2	Modify	95
5.3	Find	96
5.4	Replace	97
5.5	Delete block	98
5.6	Move block	99
5.7	Copy block	100
5.8	Copy to program	101
5.9	Import a program	102
5.10	Editor parameters	103
5.10.1	Autonumbering	103
5.10.2	Selection of the axes for TEACH-IN editing	104

CHAPTER 6**JOG**

6.1	Jog	110
6.1.1	Continuous Jog	110
6.1.2	Incremental jog	111
6.1.3	Path-jog mode	112
6.2	Movement with an electronic handwheel	113
6.2.1	General or individual handwheel mode	114
6.2.2	Path handwheel	115
6.2.3	Feed handwheel mode	116
6.2.4	"Additive handwheel" mode	117
6.3	Spindle movement	119

CHAPTER 7**TABLES**

7.1	Zero offset table	123
7.2	Tool magazine table	124
7.3	Tool table	125
7.4	Tool Offset table	127
7.5	Tool geometry table	131
7.5.1	How to edit the tool geometry table	134
7.6	Global and local parameters tables	135
7.7	How to edit tables	136

CHAPTER 8**UTILITIES**

8.1	Accessing the programs without using the explorer	140
8.1.1	Directory	140
8.1.2	Copy	143
8.1.3	Delete	144
8.1.4	Rename	145
8.1.5	Protections	146
8.1.6	Change date	148
8.2	Accessing the programs using the explorer	149

CHAPTER 9**STATUS**

9.1	CNC	154
9.1.1	Data backup copy. Backup - Restore	155
9.2	DNC	158
9.2.1	Phone call (telediagnosis)	160
9.3	Sercos	161
9.4	CAN	162

CHAPTER 10**PLC**

10.1	Edit	164
10.2	Compile	168
10.3	Monitoring	169
10.3.1	Monitoring with the PLC in operation and with the PLC stopped	174
10.3.2	PLC monitoring in ladder diagram language	176
10.4	Active messages	179
10.5	Active pages (screens)	179
10.6	Save program	179
10.7	Restore program	180
10.8	Resources in use	180
10.9	Statistics	181
10.10	Logic analyzer	183
10.10.1	Description of the work screen	183
10.10.2	Selection of variables and trigger conditions	185
10.10.3	Execute trace	188



CNC 8055
CNC 8055i

-T- MODEL
SOFT: V01.3X

CHAPTER 11 SCREEN EDITOR

11.1	Utilities	195
11.2	Editing user screens (pages) and symbols	197
11.3	Graphic elements	200
11.4	Texts	204
11.5	Modifications	206

CHAPTER 12 MACHINE PARAMETERS

12.1	Machine parameter table	210
12.2	Miscellaneous function tables "M"	211
12.3	Leadscrew error compensation tables	212
12.4	Cross compensation table	213
12.5	Operation with parameter tables	214

CHAPTER 13 DIAGNOSIS

13.1	Configuration	218
13.2	Hardware test	219
13.3	Tests	220
13.4	Adjustments	221
13.4.1	Circle geometry test	221
13.4.2	Oscilloscope	223
13.5	User	232
13.6	Hard disk	232
13.7	Interesting notes	233

CHAPTER 14 CNC - PC COMMUNICATION. TELEDIAGNOSIS

14.1	Direct connection through the serial line or Ethernet	237
14.2	Telephone connection from a PC	238
14.3	Normal phone call	239
14.4	Advanced phone call	240
14.4.1	Configuration of an incoming connection at the PC	242
14.5	Internet phone call	244



**CNC 8055
CNC 8055i**

-T- MODEL
SOFT: V01.3x



CNC 8055
CNC 8055i

·T· MODEL
SOFT: V01.3x

ABOUT THE PRODUCT

BASIC CHARACTERISTICS OF THE DIFFERENT MODELS.

	8055 FL 8055i FL 8055i FL EN	8055 Power 8055i Power
Built-in	8055i FL 8055i FL EN	8055i Power
Enclosure	8055 FL	8055 Power
USB	Standard	Standard
Block processing time	3,5 ms	0,9 ms
RAM memory	1Mb	1 Mb
Software for 7 axes	-----	Option
TCP transformation	-----	Option
C axis (Lathe)	-----	Option
Y axis (Lathe)	-----	Option
Look-ahead	100 blocks	200 blocks
512Mb / 2Gb flash memory	Option 512Mb on the EN model	Option

HARDWARE OPTIONS OF THE 8055I CNC

	Analog	Digital	Engraving
Ethernet	Option	Option	Option
RS-232 serial line	Standard	Standard	Standard
16 digital inputs and 8 outputs (I1 to I16 and O1 to O8)	Standard	Standard	Standard
Another 40 digital inputs and 24 outputs (I65 to I104 and O33 to O56)	Option	Option	Option
Probe inputs	Standard	Standard	Standard
Spindle (feedback input and analog output)	Standard	Standard	Standard
Electronic handwheels	Standard	Standard	Standard
4 axes (feedback and velocity command)	Option	Option	---
Remote CAN modules, for digital I/O expansion (RIO).	Option	Option	---
Sercos servo drive system for Fagor servo drive connection.	---	Option	---
CAN servo drive system for Fagor servo drive connection.	---	Option	---



Before start-up, verify that the machine that integrates this CNC meets the 89/392/CEE Directive.

FAGOR

CNC 8055
CNC 8055i

SOFTWARE OPTIONS OF THE 8055 CNC AND 8055I CNC

About the product

	Model							
	GP	M	MC	MCO	EN	T	TC	TCO
Number of axes with standard software	4	4	4	4	3	2	2	2
Number of axes with optional software	7	7	7	7	-----	4 or 7	4 or 7	4 or 7
Electronic threading	-----	Stand	Stand	Stand	Stand	Stand	Stand	Stand
Tool magazine management:	-----	Stand	Stand	Stand	-----	Stand	Stand	Stand
Machining canned cycles	-----	Stand	Stand	-----	Stand	Stand	Stand	-----
Multiple machining	-----	Stand	Stand	-----	Stand	-----	-----	-----
Solid graphics	-----	Stand	Stand	Stand	-----	Stand	Stand	Stand
Rigid tapping	-----	Stand	Stand	Stand	Stand	Stand	Stand	Stand
Tool live monitoring	-----	Opt	Opt	Opt	Stand	Opt	Opt	Opt
Probing canned cycles	-----	Opt	Opt	Opt	Stand	Opt	Opt	Opt
DNC	Stand	Stand	Stand	Stand	Stand	Stand	Stand	Stand
COCOM version	Opt	Opt	Opt	Opt	-----	Opt	Opt	Opt
Profile editor	Stand	Stand	Stand	Stand	-----	Stand	Stand	Stand
Tool radius compensation	Stand	Stand	Stand	Stand	Stand	Stand	Stand	Stand
Tangential control	Opt	Opt	Opt	Opt	-----	Opt	Opt	Opt
Retracing	-----	Opt	Opt	Opt	Stand	Opt	Opt	Opt
Setup assistance	Stand	Stand	Stand	Stand	Stand	Stand	Stand	Stand
Irregular pockets with islands	-----	Stand	Stand	Stand	-----	-----	-----	-----
TCP transformation	-----	Opt	Opt	Opt	-----	-----	-----	-----
C axis (on Lathe)	-----	-----	-----	-----	-----	Opt	Opt	Opt
Y axis (on Lathe)	-----	-----	-----	-----	-----	Opt	Opt	Opt
Telediagnosis	Opt	Opt	Opt	Opt	Stand	Opt	Opt	Opt



CNC 8055
CNC 8055i

DECLARATION OF CONFORMITY

The manufacturer:

Fagor Automation S. Coop.
Barrio de San Andrés Nº 19, C.P. 20500, Mondragón -Guipúzcoa- (SPAIN).

Declares:

Under their responsibility that the product:

NUMERICAL CONTROL 8055 / 8055i

Consisting of the following modules and accessories:

MONITOR-8055, MONITOR-55-11-USB
OP-8055
KS 50/55, KB-40/55-ALFA, DVD AMPLI 8055
PSB-8055
CPU-KEY CF 8055 FL LARGE, CPU-KEY CF 8055 Power LARGE
AXES 8055 VPP
I/O 8055, COVER 8055, SERCOS 8055
Remote modules RIO
CNC 8055i FL, CNC 8055i Power
ANALOG 8055i-B, 40I/24O-8055i-B, ANALOG+40I/24O-B, COVER ANA+I/O-8055i-B
ETHERNET-CAN-SERCOS, ETHERNET-CAN-CAN AXES, ETHERNET-CAN AXES

Note. Some additional characters may follow the references mentioned above. They all comply with the directives listed. However, check that that's the case by checking the label of the unit itself.

Referred to by this declaration with following directives:

Low voltage regulations.

EN 60204-1: 2006 Electrical equipment on machines — Part 1. General requirements.

Regulation on electromagnetic compatibility.

EN 61131-2: 2007 Programmable PLC's — Part 2. Unit requirements and tests.

As instructed by the European Community Directives 2006/95/EEC on Low Voltage and 2004/108/EC on Electromagnetic Compatibility and its updates.

In Mondragón, July 27th, 2010

Fagor Automation, S. Coop.

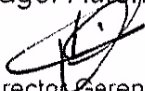
Director Gerente
Pedro Ruiz de Aguirre

FAGOR 

CNC 8055
CNC 8055i

VERSION HISTORY

Here is a list of the features added in each software version and the manuals that describe them.

The version history uses the following abbreviations:

INST	Installation manual
PRG	Programming manual
OPT	Operating manual
OPT-MC	Operating manual for the MC option.
OPT-TC	Operating manual for the TC option.
OPT-CO	Manual of the CO manual

Software V01.00 October 2010

First version.

Software V01.20 April 2011

List of features	Manual
Open communication.	INST
Improvements to Look Ahead machining.	INST
Blocks with helical interpolation in G51.	PRG
G84. Tapping with relief.	PRG

Software V01.08 August 2011

List of features	Manual
S.m.p. OPLDECTI (P86).	INST

Software V01.30 September 2011

List of features	Manual
Gear ratio management on Sercos spindles	INST
Improved feedrate limit management (FLIMIT).	INST
New type of penetration in lathe type threading cycles.	PRG
Improved lathe type thread repair. Partial repair.	PRG
MC option: Rigid tapping with relief.	OPT-MC
TC option: New type of penetration in threading cycles.	OPT-TC
TC option: Improved thread repair. Partial and multi-entry (start) thread repair.	OPT-TC
TC option: Zig-zag entry to the groove at the starting point of the groove.	OPT-TC



CNC 8055
CNC 8055i

List of features	Manual
CNC 8055 FL Engraving model	INST/OPT/PRG

Version history



CNC 8055
CNC 8055i

SAFETY CONDITIONS

Read the following safety measures in order to prevent harming people or damage to this product and those products connected to it.

This unit may only be repaired by authorized personnel at Fagor Automation.

Fagor Automation shall not be held responsible of any physical damage or defective unit resulting from not complying with these basic safety regulations.

PRECAUTIONS AGAINST PERSONAL DAMAGE

- Interconnection of modules.
Use the connection cables provided with the unit.
- Use proper Mains AC power cables
To avoid risks, use only the Mains AC cables recommended for this unit.
- Avoid electrical overloads.
In order to avoid electrical discharges and fire hazards, do not apply electrical voltage outside the range selected on the rear panel of the central unit.
- Ground connection.
In order to avoid electrical discharges, connect the ground terminals of all the modules to the main ground terminal. Before connecting the inputs and outputs of this unit, make sure that all the grounding connections are properly made.
- Before powering the unit up, make sure that it is connected to ground.
In order to avoid electrical discharges, make sure that all the grounding connections are properly made.
- Do not work in humid environments.
In order to avoid electrical discharges, always work under 90% of relative humidity (non-condensing) and 45 °C (113° F).
- Do not work in explosive environments.
In order to avoid risks or damages, do no work in explosive environments.



CNC 8055
CNC 8055i

PRECAUTIONS AGAINST PRODUCT DAMAGE

- Working environment.

This unit is ready to be used in industrial environments complying with the directives and regulations effective in the European Community.

Fagor Automation shall not be held responsible for any damage suffered or caused when installed in other environments (residential or homes).

- Install this unit in the proper place.

It is recommended, whenever possible, to install the CNC away from coolants, chemical product, blows, etc. that could damage it.

This unit complies with the European directives on electromagnetic compatibility. Nevertheless, it is recommended to keep it away from sources of electromagnetic disturbance such as:

- Powerful loads connected to the same AC power line as this equipment.
- Nearby portable transmitters (Radio-telephones, Ham radio transmitters).
- Nearby radio/TV transmitters.
- Nearby arc welding machines.
- Nearby High Voltage power lines.
- Etc.

- Enclosures.

The manufacturer is responsible of assuring that the enclosure involving the equipment meets all the currently effective directives of the European Community.

- Avoid disturbances coming from the machine tool.

The machine-tool must have all the interference generating elements (relay coils, contactors, motors, etc.) uncoupled.

- DC relay coils. Diode type 1N4000.
- AC relay coils. RC connected as close to the coils as possible with approximate values of $R=220 \Omega / 1 \text{ W}$ and $C=0,2 \mu\text{F} / 600 \text{ V}$.
- AC motors. RC connected between phases, with values of $R=300 \Omega / 6 \text{ W}$ and $C=0,47 \mu\text{F} / 600 \text{ V}$.

- Use the proper power supply.

Use an external regulated 24 Vdc power supply for the inputs and outputs.

- Grounding of the power supply.

The zero volt point of the external power supply must be connected to the main ground point of the machine.

- Analog inputs and outputs connection.

It is recommended to connect them using shielded cables and connecting their shields (mesh) to the corresponding pin.

- Ambient conditions.

The working temperature must be between $+5 \text{ }^\circ\text{C}$ and $+40 \text{ }^\circ\text{C}$ (41°F and 104°F)

The storage temperature must be between $-25 \text{ }^\circ\text{C}$ and $+70 \text{ }^\circ\text{C}$. ($-13 \text{ }^\circ\text{F}$ and $158 \text{ }^\circ\text{F}$)

- Monitor enclosure (8055) or central unit (8055i).

Guarantee the required gaps between the monitor or the central unit and each wall of the enclosure. Use a DC fan to improve enclosure ventilation.

- Power switch.

This power switch must be mounted in such a way that it is easily accessed and at a distance between 0.7 meters (27.5 inches) and 1.7 meters (5.5ft) off the floor.

PROTECTIONS OF THE UNIT ITSELF (8055)

- "Axes" and "Inputs/Outputs" modules.

All the digital inputs and outputs have galvanic isolation via optocouplers between the CNC circuitry and the outside.

They are protected by an external fast fuse (F) of 3.15 A 250V against overvoltage of the external power supply (over 33 Vdc) and against reverse connection of the power supply.

- Monitor.

The type of protection fuse depends on the type of monitor. See identification label of the unit itself.

PROTECTIONS OF THE UNIT ITSELF (8055I)

- Central Unit.

It has a 4 A 250V external fast fuse (F).

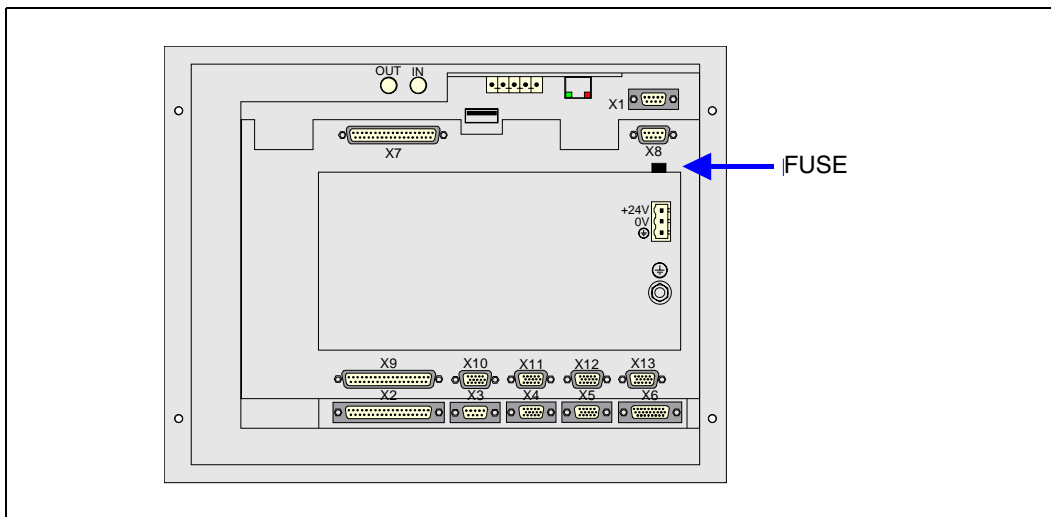

- Inputs-Outputs.

All the digital inputs and outputs have galvanic isolation via optocouplers between the CNC circuitry and the outside.

PRECAUTIONS DURING REPAIR



Do not open this unit. Only personnel authorized by Fagor Automation may open this unit. Do not handle the connectors with the unit connected to mains. Before manipulating the connectors (inputs/outputs, feedback, etc.) make sure that the unit is not connected to AC power.

SAFETY SYMBOLS

- Symbols which may appear on the manual.



*Symbol for danger or prohibition.
It indicates actions or operations that may cause damage to people or to units.*



*Warning symbol.
It indicates situations that may be caused by certain operations and the actions to be taken to prevent them.*



*Obligation symbol.
It indicates actions and operations that must be carried out.*



*Information symbol.
It indicates notes, warnings and advises.*

WARRANTY TERMS

INITIAL WARRANTY

All products manufactured or marketed by FAGOR carry a 12-month warranty for the end user which could be controlled by the our service network by means of the warranty control system established by FAGOR for this purpose.

In order to prevent the possibility of having the time period from the time a product leaves our warehouse until the end user actually receives it run against this 12-month warranty, FAGOR has set up a warranty control system based on having the manufacturer or agent inform FAGOR of the destination, identification and on-machine installation date, by filling out the document accompanying each FAGOR product in the warranty envelope. This system, besides assuring a full year of warranty to the end user, enables our service network to know about FAGOR equipment coming from other countries into their area of responsibility.

The warranty starting date will be the one appearing as the installation date on the above mentioned document. FAGOR offers the manufacturer or agent 12 months to sell and install the product. This means that the warranty starting date may be up to one year after the product has left our warehouse so long as the warranty control sheet has been sent back to us. This translates into the extension of warranty period to two years since the product left our warehouse. If this sheet has not been sent to us, the warranty period ends 15 months from when the product left our warehouse.

This warranty covers all costs of material and labour involved in repairs at FAGOR carried out to correct malfunctions in the equipment. FAGOR undertakes to repair or replace their products within the period from the moment manufacture begins until 8 years after the date on which it disappears from the catalogue.

FAGOR has exclusive competence in deciding whether the repair enters within the term defined as the warranty period.

EXCLUDING CLAUSES

Repairs will be carried out on our premises. Therefore, all expenses incurred as a result of trips made by technical personnel to carry out equipment repairs, despite these being within the above-mentioned period of warranty, are not covered by the warranty.

Said warranty will be applied whenever the equipment has been installed in accordance with instructions, has not be mistreated, has not been damaged by accident or by negligence and has not been tampered with by personnel not authorised by FAGOR. If, once servicing or repairs have been made, the cause of the malfunction cannot be attributed to said elements, the customer is obliged to cover the expenses incurred, in accordance with the tariffs in force.

Other warranties, implicit or explicit, are not covered and FAGOR AUTOMATION cannot be held responsible for other damages which may occur.



CNC 8055
CNC 8055i

WARRANTY ON REPAIRS

In a similar way to the initial warranty, FAGOR offers a warranty on standard repairs according to the following conditions:

PERIOD	12 months.
CONCEPT	Covers parts and labor for repairs (or replacements) at the network's own facilities.
EXCLUDING CLAUSES	The same as those applied regarding the chapter on initial warranty. If the repair is carried out within the warranty period, the warranty extension has no effect.

When the customer does not choose the standard repair and just the faulty material has been replaced, the warranty will cover just the replaced parts or components within 12 months.

For sold parts the warranty is 12 months length.

MAINTENANCE CONTRACTS

The SERVICE CONTRACT is available for the distributor or manufacturer who buys and installs our CNC systems.

MATERIAL RETURNING TERMS

When sending the central nit or the remote modules, pack them in its original package and packaging material. If the original packaging material is not available, pack it as follows:

1. Get a cardboard box whose three inside dimensions are at least 15 cm (6 inches) larger than those of the unit. The cardboard being used to make the box must have a resistance of 170 kg. (375 pounds).
2. Attach a label indicating the owner of the unit, person to contact, type of unit and serial number.
3. In case of failure, also indicate the symptom and a short description.
4. Wrap the unit in a polyethylene roll or similar material to protect it.
5. When sending the central unit, protect especially the screen.
6. Pad the unit inside the cardboard box with polyurethane foam on all sides.
7. Seal the cardboard box with packing tape or industrial staples.



CNC 8055
CNC 8055i



Material returning terms



CNC 8055
CNC 8055i

ADDITIONAL REMARKS

Mount the CNC away from coolants, chemical products, blows, etc. which could damage it. Before turning the unit on, verify that the ground connections have been properly made.

To prevent electrical shock at the central unit of the 8055 CNC, use the proper mains AC connector at the power supply module. Use 3-wire power cables (one for ground connection).

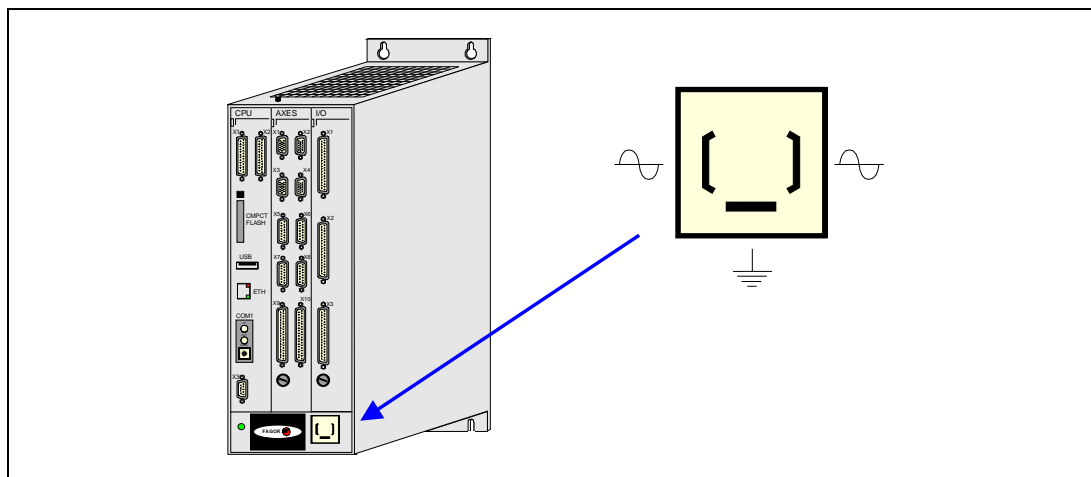

To prevent electrical shock at the monitor of the 8055 CNC, use the proper mains AC connector (A) with 3-wire power cables (one of them for ground connection).

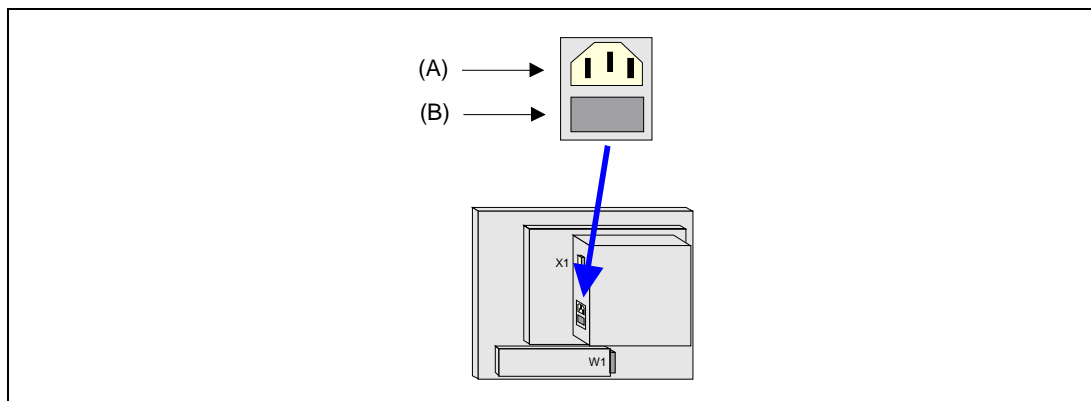

Before turning on the monitor of the 8055 CNC and verifying that the external AC line (B) fuse of each unit is the right one. See identification label of the unit itself.

In case of a malfunction or failure, disconnect it and call the technical service. Do not get into the inside of the unit.

FAGOR 

CNC 8055
CNC 8055i



Additional remarks



CNC 8055
CNC 8055i

FAGOR DOCUMENTATION

OEM manual

It is directed to the machine builder or person in charge of installing and starting-up the CNC.

USER-M manual

Directed to the end user.

It describes how to operate and program in M mode.

USER-T manual

Directed to the end user.

It describes how to operate and program in T mode.

MC Manual

Directed to the end user.

It describes how to operate and program in MC mode.

It contains a self-teaching manual.

TC Manual

Directed to the end user.

It describes how to operate and program in TC mode.

It contains a self-teaching manual.

MCO/TCO model

Directed to the end user.

It describes how to operate and program in MCO and TCO mode.

Examples-M manual

Directed to the end user.

It contains programming examples for the M mode.

Examples-T manual

Directed to the end user.

It contains programming examples for the T mode.

WINDNC Manual

It is directed to people using the optional DNC communications software.

It is supplied in a floppy disk with the application.

WINDRAW55 manual

Directed to people who use the WINDRAW55 to create screens.

It is supplied in a floppy disk with the application.



CNC 8055
CNC 8055i



Fagor documentation



CNC 8055
CNC 8055i

GENERAL CONCEPTS

1

This manual describes how to operate with the CNC with the monitor-keyboard and the operator panel.

The Monitor-Keyboard unit consists of:

- The Monitor or CRT screen, which is used to show the required system information.
- The keyboard is used to communicate with the CNC; the operator may request information on commands or change the CNC status using new instructions.



CNC 8055
CNC 8055i

·T· MODEL
SOFT: V01.3x

1.1 Part programs

Editing

To create a part-program, access the Edit mode.

The new part-program edited can be stored in the CNC's RAM memory, in the hard disk (KeyCF) or in a remote disk. It is also possible to save a copy of the part-programs in a PC connected through the serial line. See UTILITIES mode.

When using a PC through serial line, proceed as follows:

- Execute the WINDNC application program at the PC.
- Activate DNC communications at the CNC.
- Select the work directory.
Option: Utilities\ Directory\ Serial L.\ Change directory.

In the edit mode, it is possible to modify the part-programs located in the CNC's RAM memory, in a hard disk (KeyCF) or in a remote disk.

Execution

Part-programs stored anywhere may be executed or simulated.

The user customizing programs must be in RAM memory so the CNC can execute them.

The GOTO and RPT instructions cannot be used in programs that are executed from a PC connected through the serial line.

Only subroutines stored in the CNC's RAM memory can be executed. Therefore, to execute a subroutine stored in a PC or in the hard disk, it must be copied into the CNC's RAM memory.

From a program in execution, it is possible to execute another program located in RAM memory, in a PC or in the hard disk using the EXEC instruction.

Utilities

The utilities mode, lets display the part-program directory of all the devices, make copies, delete, rename and even set the protections for any of them.

Ethernet

When having the Ethernet option and the CNC has been configured as a node within the computer network, the following is possible from any PC of the network:

- Access the part-program directory of the hard disk (KeyCF).
- Edit, modify, delete, rename, etc., the programs stored on the hard disk (KeyCF).
- Copy programs from the hard disk to the PC and vice versa.

Operations that may be carried out with part-programs:

1.

GENERAL CONCEPTS
Part programs



CNC 8055
CNC 8055i

-T- MODEL
SOFT: V01.3x

	RAM	Hard disk	DNC
See the program directory of ...	Yes	Yes	Yes
See the subroutine directory of ...	Yes	No	No
Create the work directory from ...	No	No	No
Change the work directory from ...	No	No	Yes
Edit a program from ...	Yes	Yes	No
Modify a program from ...	Yes	Yes	No
Delete a program from ...	Yes	Yes	Yes
Copy from/to RAM memory to/from ...	Yes	Yes	Yes
Copy from/to hard disk to/from ...	Yes	Yes	Yes
Copy from/to DNC to/from ...	Yes	Yes	Yes
Rename a program from ...	Yes	Yes	No
Change the comment of a program from ...	Yes	Yes	No
Change the protections of a program from ...	Yes	Yes	No
Execute a part-program from ...	Yes	Yes	Yes
Execute a user program from ...	Yes	Yes	No
Execute a PLC program from ...	Yes	No	No
Execute programs with GOTO or RPT instructions from ...	Yes	Yes	No
Execute subroutines residing in ...	Yes	No	No
Execute programs with the EXEC instruction, in RAM from ...	Yes	Yes	Yes
Execute programs with the EXEC instruction, in hard disk from ...	Yes	Yes	Yes
Execute programs with the EXEC instruction, in DNC from ...	Yes	Yes	No
Open programs with the OPEN instruction, in RAM from ...	Yes	Yes	Yes
Open programs with the OPEN instruction, in hard disk from ...	Yes	Yes	Yes
Open programs with the OPEN instruction, in DNC from ...	Yes	Yes	No
Via Ethernet:			
See from a PC the program directory of ...	No	Yes	No
See from a PC the subroutine directory of ...	No	No	No
See from a PC, a directory in ...	No	No	No

1.

GENERAL CONCEPTS
Part programs



CNC 8055
CNC 8055i

.T. MODEL
SOFT: V01.3x

1.2 Monitor information layout

The monitor is divided into the following areas or display windows:

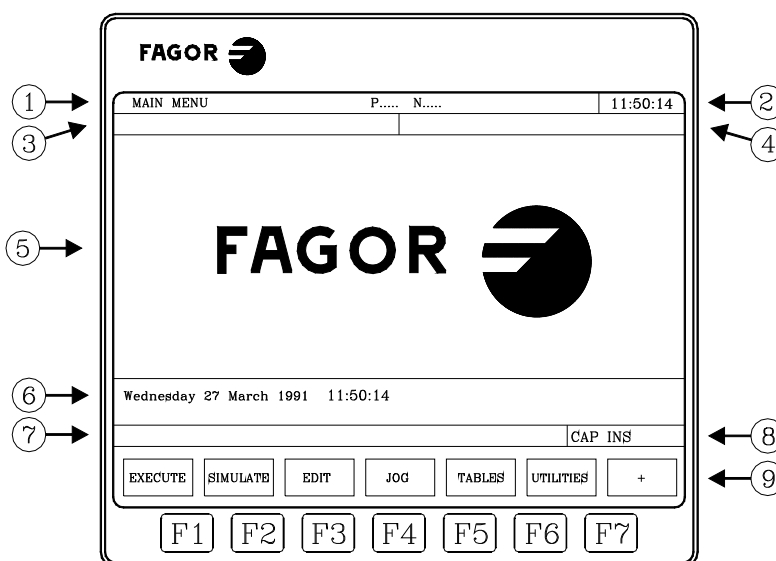

1. This window indicates the selected operating mode, as well as the program number and the number of the active block. The program status is also indicated (in execution or interrupted) and if the DNC is active.
2. This window indicates the time in the " hours : minutes : seconds".
3. This window displays the messages sent to the operator from the part program or via DNC. The last message received will be shown regardless of where it has come from.
4. This window will display messages from the PLC.

If the PLC activates two or more messages, the CNC will always display the one with the highest priority, which is the message with the smallest number. In this way, MSG1 will have the highest priority and MSG255 will have the lowest.

In this case the CNC will display the character + (plus sign), indicating that there are more messages activated by the PLC, it being possible to display them if the ACTIVE MESSAGE option is accessed in the PLC mode.

In this window the CNC will also display the character * (asterisk), to indicate that at least one of the 256 user-defined screens is active.

The screens which are active will be displayed, one by one, if the ACTIVE PAGES option is accessed in the PLC mode.
5. Main window.

Depending on the operating mode, the CNC will show in this window all the information necessary.

When a CNC or PLC error is produced the system displays this in a superimposed horizontal window.

The CNC will always display the most important error. The CNC will show the [↓] key to indicate that another less important error has also occurred and to press this key to view its message. The CNC will show the [↑] key to indicate that another more important error has also occurred and to press this key to view its message.
6. Editing window.

In some operating modes the last four lines of the main window are used as editing area.
7. CNC reports window. (errors detected in edition, nonexistent program, etc.).

1.

GENERAL CONCEPTS
Monitor information layout



CNC 8055
CNC 8055i

-T- MODEL
SOFT: V01.3x

8. This window shows the following information:

SHF	Indicates that the [SHIFT] key has been pressed to activate the second function of the keys. For example, if the [9] key is pressed after the [SHIFT] key, the CNC will understand that the "\$" character is required.
CAP	This indicates capital letters ([CAPS] key). The CNC will understand that capital letters are required whenever this is active.
INS/REP	Indicates if it is insert mode (INS) or substitution (REP) mode. It is selected by means of the [INS] key.
MM/INCH	Indicates the unit system (millimeters or inches) selected for display.

9. Shows the different options which can be selected with soft-keys F1 thru F7.



GENERAL CONCEPTS
Monitor information layout



CNC 8055
CNC 8055i

.T. MODEL
SOFT: V01.3x

1.3 Keyboard layout

Depending on the utility of the different keys, the CNC keyboard may be considered to be laid out as follows:

Alphanumeric keyboard for the data entry in memory, selection of axes, tool offset, etc.

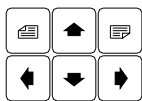

Keys which allow the information shown on screen to be moved forward or backward, page to page or line to line, as well as moving the cursor all over the screen.

- [CL][CLEAR] To delete the character over which the cursor is positioned or the last one entered if the cursor is at the end of the line.
- [INS] To select the insert or overwrite mode.
- [ENTER] To validate the CNC and PLC commands generated in the editing window.
- [HELP] To access to the help system in any operating mode.
- [RESET] To initialize the history of the program in execution, by assigning it the values defined by machine parameters. It is necessary for the program to be stopped for the CNC to accept this key.
- [ESC] To go back to the previous operating option shown on the monitor.
- [MAIN MENU] To access the CNC's main menu directly.
- [RECALL] In conversational modes, it assigns the value of a coordinate to the selected field.
- [PPROG] In the conversational modes, it accesses the list of part-programs stored.
- [F1] to [F7] Softkeys or functions keys for selecting the different operating options shown on the monitor.

Specific keys to select canned cycles in the MC and TC work modes.

There are also the following special keystroke sequences:

[SHIFT]+[RESET]

The result of this keystroke sequence is the same as turning the CNC off and back on. This option must be used after modifying the CNC's machine parameters so they're assumed by the CNC.

[SHIFT]+[CL]

This keystroke sequence clears (blanks out) the CRT screen. Press any key to restore its normal state.

If an error occurs or a PLC/CNC message is received while the screen is blank, the screen restores its normal state.

[SHIFT]+[next page]

To display on the right hand side of the screen the position of the axes and the status of the program in progress.

It may be used in any operating mode.

Press the same keystroke sequence to restore the previous display.

1.3.1 The EDIT, SIMUL and EXEC keys

The keyboards of the M and T models have these new keys:

"EDIT"	To access the editing mode.
"SIMUL"	To access the simulation mode.
"EXEC"	To access the execution mode.

In the MC, TC and MCO/TCO modes, these direct accesses are available when working in M or T mode (non-conversational). To access them, use the "P.PROG" key instead of "EDIT" and the "GRAPHICS" key instead of "SIMUL".

Direct access to the editing mode, "EDIT" key.

When pressing this key in the editing and simulation modes, one edits the last program simulated or executed. If the corresponding program is being executed or simulated, one will edit the one that was last edited.

When pressing this key in any other work mode, it starts editing the last program edited.

If there is no previous program, it requests the name of a new program.

To restrict the editing to the last program edited, simulated or executed, assign to the NEXEDI variable one of the following values:

NEXEDI=0	Not restricted, it opens the last one edited, simulated or executed.
NEXEDI=1	Always the last program edited.
NEXEDI=2	Always the last program simulated.
NEXEDI=3	Always the last program executed.

If the corresponding program is being executed or simulated, it issues a warning. If there is no previous program, it requests the name of a new program.

Direct access to the simulation mode, "SIMUL" key.

Pressing this key starts the simulation of the last program edited, simulated or executed. If there is no previous program, it requests the name of a new program.

If the simulation or execution mode is active, only the active mode will be shown, no program is selected.

To restrict the simulation to the last program edited, simulated or executed, assign to the NEXSIM variable one of the following values:

NEXSIM=0	Not restricted, it opens the last one edited, simulated or executed.
NEXSIM=1	Always the last program edited.
NEXSIM=2	Always the last program simulated.
NEXSIM=3	Always the last program executed.

If the corresponding program is being executed or simulated, it issues a warning. If there is no previous program, it requests the name of a new program.



Direct access to the execution mode, "EXEC" key.

Pressing this key starts the execution of the last program edited, simulated or executed. If there is no previous program, it requests the name of a new program.

If the simulation or execution mode is active, only the active mode will be shown, no program is selected.

To restrict the execution to the last program edited, simulated or executed, assign to the NEXEXE variable one of the following values:

NEXEXE=0 Not restricted, it opens the last one edited, simulated or executed.

NEXEXE=1 Always the last program edited.

NEXEXE=2 Always the last program simulated.

NEXEXE=3 Always the last program executed.

If the corresponding program is being executed or simulated, it issues a warning. If there is no previous program, it requests the name of a new program.

1.**GENERAL CONCEPTS**
Keyboard layout

CNC 8055
CNC 8055i

·T· MODEL
SOFT: V01.3x

1.4 Layout of the operator panel

Depending on the utility of the different parts, the CNC operator panel may be considered to be laid out as follows.

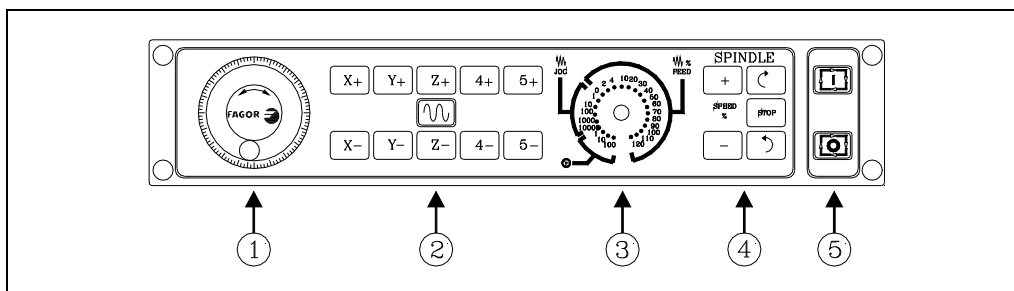

1. Position of the emergency button or electronic handwheel.
2. Keyboard for manual movement of axes.
3. Selector switch with the following functions:
 - Select the multiplication factor of the number of pulses from the electronic handwheel (1, 10 or 100).
 - Select the incremental value of the movement of the axes in movements made in the "JOG" mode.
 - Modify the programmed axis feedrate between 0% and 120%
4. Keyboard which allows the spindle to be controlled, it being possible to activate it in the desired direction, stop it or vary the programmed turning speed between percentage values established by means of spindle machine parameters "MINSOVR" and "MAXOVR", with an incremental step established by means of the spindle machine parameter "SOVRSTEP".
5. Keyboard for CYCLE START and CYCLE STOP of the block or program to be executed.

1.

GENERAL CONCEPTS
Layout of the operator panel

FAGOR 

CNC 8055
CNC 8055i

-T- MODEL
SOFT: V01.3x

1.

GENERAL CONCEPTS

Layout of the operator panel



CNC 8055
CNC 8055i

·T· MODEL
SOFT: V01.3x

After turning on the CNC, or after pressing the sequence of [SHIFT]+[RESET] keys, the FAGOR logo will appear in the main window of the monitor or the screen previously prepared as page 0 by means of the screen customizing (graphic editor) tools.

If the CNC shows the message " Initialize? (ENTER / ESC) ", it should be borne in mind that after pressing the [ENTER] key, all the information stored in memory and the machine parameters are initialized to default values indicated in the installation manual.

On the lower part of the screen the main CNC menu will be shown, it being possible to select the different operating modes by means of the softkeys F1 thru F7. Whenever the CNC menu has more options than number of softkeys (7), the character "+" will appear in softkey F7. If this softkey is pressed the CNC will show the rest of the options available.

Main menu options

The options which the main CNC menu will show after turning it on, after pressing the key sequence [SHIFT]+[RESET] or after pressing the [MAIN MENU] softkey are:

EXECUTE	Allows the execution of part programs in automatic or single block.
SIMULATE	Allows simulation of parts programs in several modes.
EDIT	Allows editing new and already-existing part programs.
JOG	Allows manual control of the machine by means of the operator panel keys.
TABLES	Allows CNC tables relating to part programs (zero offsets, tool offsets, tools, tool magazine as well as global or local arithmetic parameters) to be manipulated.
UTILITIES	Allows program manipulation (copy, delete, rename, etc.)
STATUS	It shows the CNC status and that of the DNC communication lines. It also lets activate and deactivate the communication with a PC through DNC.
PLC	Allows operation with the PLC (edit the program, monitor, change the status of its variables, access to the active messages, errors, pages, etc).
GRAPHIC EDITOR	Allows, by means of a simple graphics editor, the creation of user-defined screens (pages), which can later be activated from the PLC, used in customized programs or presented when the unit is powered on (page 0).
MACHINE PARAMETERS	Allows the machine parameters to be set to adapt the CNC to the machine.
DIAGNOSIS	Makes a test of the CNC.

While the CNC is executing or simulating a part program it allows any other type of operating mode to be accessed without stopping the execution of the program. In this way it is possible to edit a program while another is being executed or simulated.

It is not possible to edit the program which is being executed or simulated, nor execute or simulate two part programs at the same time.



CNC 8055
CNC 8055i

.T. MODEL
SOFT: V01.3x

2.1 Help systems

The CNC allows access to the help system (main menu, operating mode, editing of commands, etc.) at any time. To do this, you must press the [HELP] key and the CNC will show the corresponding help page in the main window of the screen.



(a)



(b)

If the help consists of more than one page of information, the symbol(a) indicating that this key can be pressed to access the following page or the symbol(b) indicating that it is possible to press this key to access the previous page.

The following assistance is available:

Operating assistance

This is accessed from the operating mode menu, or when one of these has been selected but none of the options shown have been selected. In all these cases, the softkeys have a blue background color.

It offers information on the operating mode or corresponding option.

While this information is available on screen it is not possible to continue operating the CNC via the softkeys, it being necessary to press the [HELP] key again to recover the information which was on the main screen before requesting help and continuing with the operation of the CNC.

The help system can also be abandoned by pressing the [ESC] key or the [MAIN MENU] key.

Editing assistance

This is accessed once one of the editing options has been selected (part programs, PLC program, tables, machine parameters, etc.). In all these cases, the softkeys have a white background color.

It offers information on the corresponding option. While this information is available, it is possible to continue operating with the CNC.

If the [HELP] key is pressed again, the CNC analyzes if the present editing status corresponds to the same help page or not.

If another page corresponds to it, it displays this instead of the previous one and if the same one corresponds, it recovers the information which was in the main window before requesting help.

The help menu can also be abandoned after pressing the [ESC] key, to return to the previous operating option, or the [MAIN MENU] key to return to the main menu.

2.

Canned cycle editing assistance

It is possible to access this help when editing a canned cycle.

It offers information on the corresponding canned cycle and an editing assistance for the selected canned cycle is obtained at this point.

For the user's own cycles a similar editing assistance can be obtained by means of a user program. This program must be prepared with screen customizing instructions.

Once all the fields or parameters of the canned cycle have been defined the CNC will show the information existing in the main window before requesting help.

The canned cycle which is programmed by means of editing assistance will be shown in the editing window, and the operator can modify or complete this block before entering it in memory by pressing the [ENTER] key.

Editing assistance can be abandoned at any time by pressing the [HELP] key. The CNC will show the information which existed on the main window before requesting help and allows programming of the canned cycle to continue in the editing window.

The help menu can also be abandoned after pressing the [ESC] key, to return to the previous operating option, or the [MAIN MENU] key to return to the main menu.

2.

OPERATING MODES
Help systems

FAGOR 

CNC 8055
CNC 8055i

.T. MODEL
SOFT: V01.3x

2.2 Software update

The software is loaded from the <Diagnosis> mode using the option >Configuration / Software configuration / Load version<

It displays the following window:

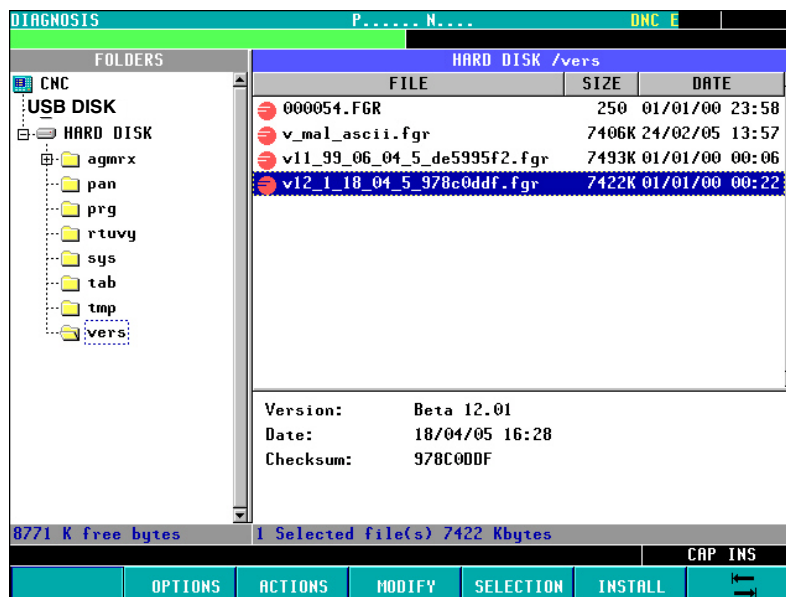

The left panel shows the system devices available and their relevant subdirectories.

The right panel is divided in two halves:

- The top shows all the files contained in the software versions (".f55" extension).
- The bottom shows the data identifying the version selected in the top half.

Loading the version

To install a version, the user must follow the following procedure:

1. Select, in the left panel, the unit containing the new version to be installed.



To install a new version located in a "remote hard disk" or in a "USB disk", first transfer the ".f55" file to the "vers" folder of the "hard disk (KeyCF)" and then it load the version as described here below.

2. Place the cursor in the right panel, on the ".f55" file and press the softkey <INSTALL>. After carrying out this task, it shows a dialog box requesting confirmation to resume the process:

F5 [OK]	resume the process
[ESC]	abort the process

3. Once the resuming of the operation has been confirmed, the CNC verifies that the file to be installed is correct. During this operation, it displays a process bar with the message "checking..."
4. Then, it loads the code contained in the ".f55" file into the system flash memory. During this operation, it displays a process bar with the message "loading..."
5. Finally, it verifies the checksum of the new version installed. This operation is identified with the message "wait..."

If there is a CNC power outage during any of these processes, when powered back up, it goes on loading the version from the interruption point.

If the interruption takes place while saving into the flash memory, it first checks the version file.

2.

OPERATING MODES
Software update

FAGOR 

CNC 8055
CNC 8055i

-T- MODEL
SOFT: V01.3x

2.3 KeyCF (KeyCompactFlash)

The KeyCF will store the CNC configuration, i.e. the validation code, the software options, user screens, PLC program backups and machine parameters. It also has memory for user programs.

Also, the CNC supports the management of several disks at the same time as well as the hard disk (KeyCF):

- USB disk. The CNC selects a folder of a USB device and it considers it like its own hard disk. From the user's point of view, the CNC has another hard disk.
- Remote hard disk. The CNC selects a directory of a PC shared in the network and it considers it like its own hard disk. From the user's point of view, the CNC has a remote hard disk. It will only store user programs.

2.

OPERATING MODES
KeyCF (KeyCompactFlash)



CNC 8055
CNC 8055i

.T. MODEL
SOFT: V01.3x

2.3.1 Directory structure

The purpose of these directories of the hard disk (hard disk, USB disk or remote disk) is to provide the user with a space to save part-programs, tables, graphic files, etc. in an orderly fashion.

Directory /Prg

By default, this directory of the hard disk will store the user programs.

The OPEN and EXEC instructions can only be used in the subdirectory /Prg of the default hard disk "by default", i.e. of the hard disk, USB disk or remote hard disk.

Directory /Tab

This directory of the hard disk will store the machine parameters and tables with the same format and the same name currently stored in the WinDNC.

The files for the parameters of an axis and for leadscrew compensation are stored in the hard disk by the axis name.

Within the parameter table for an axis, it will offer the option to <load/hard disk>. This option first checks if the file <APn> is stored:

- Axis parameters: APX, APY, ..., APC.
- Leadscrew parameters: ALX, ALY, ..., ALC.

If it's missing, it checks if the file <MXn> is stored.

- Axis parameters: MX1, MX2, ...
- Leadscrew parameters: US1, US2, ...

The same procedure will be applied with the <load/DNC> option.

Directory /Pan

This directory of the hard disk stores the graphic files with extensions <*.pan>, <*.sim> and <*.wgd>.

Directory /Vers

The user can store the different software versions in this directory of the hard disk.

2.

OPERATING MODES
Key/CF (KeyCompactFlash)



CNC 8055
CNC 8055i

-T- MODEL
SOFT: V01.3x

Accessing the system from other devices

Through the WinDNC

From WinDNC it is possible to access the files of user programs, tables and screens located in the hard disk as well as those located in the USB disk.

The WinDNC can only display the following devices:

- Memory.
- Default hard disk .

The "default hard disk" will be the first hard disk recognized by the CNC. The order of priorities is:

- 1.Hard disk (KeyCF).
- 2.USB disk.
- 3.Remote hard disk.

At the "default hard disk", only the default directory/Prg can be accessed. The rest of the subdirectories are not accessible.



Accessing the root directory of the DNC requires a WinDNC version 4.1 or higher. Likewise, sending tables <from/to> the hard disk requires a WinDNC version 4.1.

Via FTP

It is possible to access (read and write) tables, machine parameters, graphic files and programs from the network via FTP. All the disks will be available when accessing a CNC via FTP:

- Hard disk (KeyCF).
- USB disk.
- Remote hard disk.

2.**OPERATING MODES**
KeyCF (KeyCompactFlash)**FAGOR** **CNC 8055**
CNC 8055i-T- MODEL
SOFT: V01.3x

2.

OPERATING MODES

KeyCF (KeyCompactFlash)



CNC 8055
CNC 8055i

·T· MODEL
SOFT: V01.3x

The Ethernet option permits configuring the CNC as another node within the local area network. This option makes it possible to communicate with other PC's to transfer files or carrying out telediagnostic tasks.



To configure the CNC within a computer network, refer to the chapter on machine parameters for Ethernet in the installation manual.

Once the connection to Ethernet has been configured, the following types of connections are possible:

- Connection to a remote hard disk.
- Connection to a PC through WinDNC.
- Connection from a PC through an FTP client.

To communicate with the CNC, the PC must be configured just like another node within the local area network or Internet and it must have the WinDNC (V4.0 or later) installed. The communication through Ethernet does not require the DNC option.

3.1 Remote hard disk

The CNC can have a local hard disk (at the CNC itself) or a remote hard disk accessible through Ethernet.



The remote hard disk is configured by machine parameters. Refer to the chapter on machine parameters for Ethernet in the installation manual.

As remote hard disk, it is possible to use the hard disk of a PC or just a folder. This memory space may be shared by several CNC's or each may have its own memory space. The PC that makes its hard disk (server) public must be connected to the local network.

The interface and the softkeys of the CNC will be the same as if it were a local hard disk. When accessing the CNC through WinDNC or FTP, the remote hard disk behaves like a local hard disk.

Protocol used

The NFS protocol is used to communicate with the remote hard disk. This protocol must be available at the PC that is used as server.

3.**OPERATIONS VIA ETHERNET**
Remote hard disk

CNC 8055
CNC 8055i

-T- MODEL
SOFT: V01.3x

3.2 Connection to a PC through WinDNC

The PC operative system must be Windows® and it must have the WinDNC software installed (V4.0 or newer). The CNC must be configured just like another node within the local network or internet.



The access to a DNC server is configured by machine parameters. Refer to the chapter on machine parameters for Ethernet in the installation manual.

Possible connections:

- From a PC.

The connection may be initiated at any PC and addressed to any CNC. Two PC's cannot be connected to each other.

To establish the connection, the WinDNC allows the user to enter the CNC's IP address to be used for the connection.

- From a CNC.

The connection is always addressed to the DNC server. The DNC server is defined by machine parameters.

Communication status

As with the communication via serial line, the DNC status screen shows its status through Ethernet. When having the DNC available, the top of the screen shows the message "DNC E". The connection may be activated and deactivated from the softkey menu.

It is possible to connect several WinDNC (up to 10) simultaneously to the same CNC. The access protection is by operation. If several WinDNC initiate an operation, the commands are processed one by one while the rest of the WinDNC's wait.

3.

OPERATIONS VIA ETHERNET
Connection to a PC through WinDNC

FAGOR 

**CNC 8055
CNC 8055i**

.T. MODEL
SOFT: V01.3x

3.3 Access the CNC's hard disk from a PC

If the CNC is configured like another node in the network, it may be accessed from any PC of the network knowing its IP. Only the CNC's hard disk may be accessed; i.e. it is not possible to access programs in RAM nor read variables, tables, etc.

From the PC, it is possible to access the part-program directory of the hard disk and edit, modify, etc. the programs stored. It is also possible to copy programs from the hard disk to the PC and vice versa.

Protocol used

The FTP protocol is used to access the hard disk of the CNC. The FTP protocol permits transferring files between a PC and a CNC connected to a local network or to internet. The FTP client, in charge of managing the transfer, must be installed at the PC. The interface depends on the FTP client being used.



The PC operative system may be Windows, Linux or Unix.

Windows® includes an FTP client in its Internet Explorer application from version 5.x on. From Windows® 98 on, the Windows explorer has its own integrated FTP client.

When accessing the CNC from a PC via FTP, it shows the following directory structure.

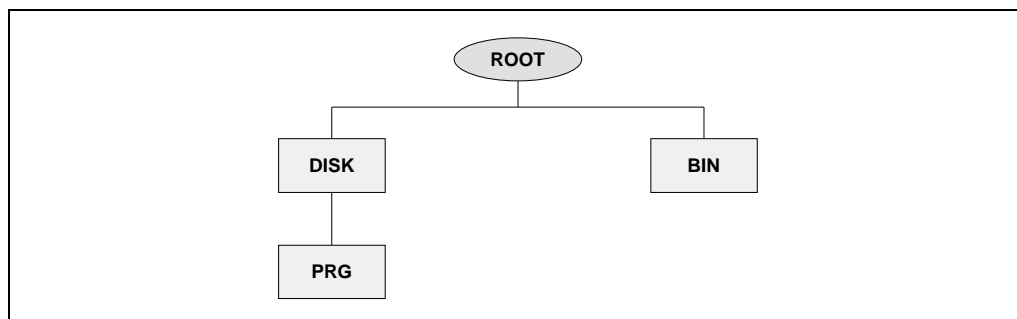

BIN	System folder used by the FTP protocol. It cannot be modified.
DISK	CNC hard disk. The user can fully access it from the PC. Although subdirectories and files may be defined, they won't be accessible from the CNC.
PRG	Part-programs and PLC programs stored at the CNC. If this folder does not exist on start-up, an empty one is created.

Although the user may create new directories through the FTP, only the programs contained in the "PRG" directory may be seen from the CNC.

If the CNC does not have a hard disk, it will show the directory empty and it will not allow sending any program.

File transfer

To copy a file from the PC to the CNC.

- In any Windows® (95, 98, 2000 or XP) system. Drag the file from one folder to another or use the keyboard shortcuts [CTRL]+[C] and [CTRL]+[V].

To copy a file from the CNC to the PC.

- In Windows® 95 or 98. Click the right mouse button on the file, select the option to "Copy to folder" and select the destination folder.
- In Windows® 2000 or XP. Drag the file from one folder to another or use the keyboard shortcuts [CTRL]+[C] (copy) and [CTRL]+[V] (paste).

3.

OPERATIONS VIA ETHERNET
Access the CNC's hard disk from a PC



CNC 8055
CNC 8055i

-T- MODEL
SOFT: V01.3x

Connection using Windows® 95 or 98

Connection with a shared CNC without password

At the Web browser (e.g. IExplorer) or from the file explorer (only on Windows 98), write in the command line the CNC's IP address.

For example: `ftp://10.0.7.224`

Connection with a shared CNC with password

At the Web browser (e.g. IExplorer) or from the file explorer (only on Windows 98), write in the command line the user name, the password and the CNC's IP address. The user name is always "cnc".

For example: `ftp://cnc:password@10.0.17.62`

Assign a name to the IP address

The IP address may be assigned a name for easier identification. This operation is carried out at the PC and there are two different ways to do it.

- Editing the file "c:\windows\hosts". This file may be modified with any text editor.

In the file, add a line containing the CNC'S IP address and the name to identify it with. For example:

```
10.0.7.40    CNC_1
10.1.6.25    MILL_MACH_01
```

On the Web browser or from the file explorer (only on Windows 98), write the defined name in the command line.

For example (CNC without password): `ftp://CNC_01.`

For example (CNC with password): `ftp://cnc:password@MILL_MACH_01`

- Through the "Favorites" menu of the Web browser.

In the Web explorer, write the IP address in the command line. After accessing the site, select the "Favorites" option on the menu > add to favorites and assign a name to that IP address. This way, it is possible to access the CNC by selecting the assigned name on the "Favorites" menu.



On the Iexplorer browser, it is called "Favorites". This name may vary depending on the Web browser being used.

Connection using Windows® 2000 or XP

The easiest way to access the CNC's hard disk from a PC is configuring a new connection. At the file explorer, select My Network sites > Add network sites. It will show the Windows help to add network sites that permits configuring the connection step by step. Press the –OK– button to go on to the next step.

Follow the instructions shown on the screen to configure the connection; refer to the Windows® help for additional information.

Connection with a shared CNC without password

1. First, select the network site, in this case an ftp folder. Write "`ftp://`" followed by the CNC's IP address defined by machine parameter DIRIP (P24).

For example: `ftp://10.0.17.62`

2. Define how the session is initiated, anonymously or not. When the CNC is shared without password, the session is initiated anonymously.
3. Define the name to be associated with the new connection. This is the name that will appear on the PC's net directory. Just select it from the list to start the connection.

For example: `FAGOR_CNC`

3.

OPERATIONS VIA ETHERNET
Access the CNC's hard disk from a PC

FAGOR 

CNC 8055
CNC 8055i

.T. MODEL
SOFT: V01.3x

Connection with a shared CNC with password

1. First, select the network site, in this case an ftp folder. Write "ftp://" followed by the CNC's IP address defined by machine parameter DIRIP (P24).

For example: ftp://10.0.17.62

2. Define the user name and how the session is initiated, anonymously or not. When the CNC is shared with password, the session is not initiated anonymously. The user must identify itself and it must be as "cnc" or "CNC".

3. Define the name to be associated with the new connection. This is the name that will appear on the PC's net directory. Just select it from the list to start the connection.

For example: FAGOR_CNC

After the configuration is done and every time the connection is made, a window will open requesting the user name and password. As user name, select "cnc" or "CNC" and as password the one defined by machine parameter CNHDPAS1 (P7).

To make it easier, the –Save password– option may be selected in this window. This way, it will no longer request the password when connecting again and it will access the hard disk directly.



Use the "save password" option with caution. Bear in mind that if you save the password, it will not be requested for the connection and, therefore, anybody is free to access the CNC from the PC.

3.

OPERATIONS VIA ETHERNET
Access the CNC's hard disk from a PC



CNC 8055
CNC 8055i

-T- MODEL
SOFT: V01.3x

The EXECUTE operating mode allows the execution of part programs in automatic mode or in single block mode.

The SIMULATE operating mode allows the simulation of part-programs in automatic or single block mode. When wished to SIMULATE a part-program, the CNC will request the type of simulation to be carried out.

When selecting one of these operating modes, one must indicate the location of the part-program to be executed or simulated. The part program may be stored in the CNC's internal RAM memory, in PC connected through the serial line or in the hard disk (KeyCF).

After pressing one of these softkeys, the CNC displays the corresponding part-program directory. The program may be selected by:

- Keying in its number and pressing [ENTER].
- Positioning the cursor of the screen over the desired program and pressing [ENTER].

The executing or simulating conditions (first block, type of graphics, etc.) may be set before executing or simulating the part-program. These conditions may also be modified if the execution or simulation is interrupted.



To execute or simulate a part-program, press the [START] key.



To switch to JOG mode once executed or simulated a part program (or a section of it), the CNC will maintain the machining conditions (type of movement, feedrates, etc.) selected while executing or simulating it.

Feedrate selection.

The program is executed at the feedrate specified in the program and may be modified between 0% and 120% using the switch on the operator panel. When doing a simulation with axis movement, the feedrate can also be modified with the switch.

The behavior of the rapid key during execution and simulation is set by machine parameters, thus it may be disabled. When enabled, the rapid key behaves as follows in execution and simulation:

- The movements are carried out in rapid traverse (G00) while the rapid key is pressed.
- The rapid key is ignored while threading, while look-ahead is active.
- If G95 is active, it switches to G94 mode. When releasing the rapid key, it goes back to G95 mode.
- It only affects the main channel. It is ignored in the PLC channel.



CNC 8055
CNC 8055i

.T. MODEL
SOFT: V01.3x

Type of simulation

When SIMULATING a part-program, the CNC requests the type of simulation desired; one of the following options must be selected with the softkeys:

	Graphic representation	Movement of the axes	Spindle control	Send to the PLC M - S - T	Send to the PLC M3 M4 M5 M41 M42 M43 M44
Theoretical path	Programmed	No	No	No	No
G functions	Theoretical tip	No	No	No	No
G, M, S, T Functions	Theoretical tip	No	No	Yes	Yes
Rapid	Theoretical tip	Yes	Yes	Yes	Yes
Rapid [S=0]	Theoretical tip	Yes	No	Yes	No

THEORETICAL PATH

It ignores tool radius compensation (functions G41, G42) thus showing the graphic representation of the programmed path.

It does not output the M, S, T function to the PLC.

It does not move the machine axes or start the spindle.

The simulation takes into account the dwells programmed with G4.

G FUNCTIONS

It takes into account tool radius compensation (functions G41, G42) thus showing the graphic representation of the path for the theoretical tool nose (it does not coincide with the programmed path).

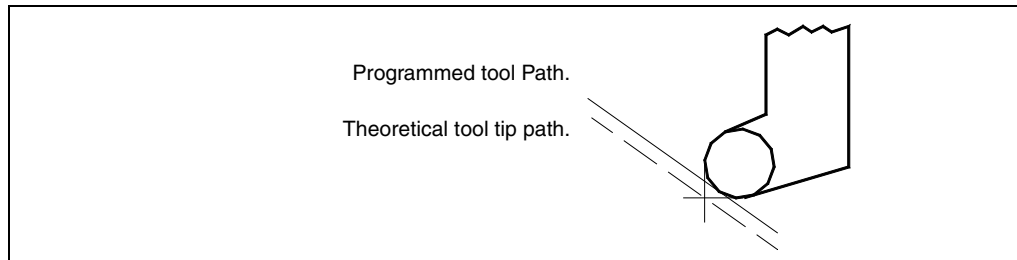

It does not output the M, S, T function to the PLC.

It does not move the machine axes or start the spindle.

The simulation takes into account the dwells programmed with G4.

G, M, S, T FUNCTIONS

It takes into account tool radius compensation (functions G41, G42) thus showing the graphic representation of the path for the theoretical tool nose.

It outputs the M, S, T functions to the PLC.

It does not move the machine axes or start the spindle.

The simulation takes into account the dwells programmed with G4.

RAPID

It takes into account tool radius compensation (functions G41, G42) thus showing the graphic representation of the path for the theoretical tool nose.

It outputs the M, S, T functions to the PLC.

It starts the spindle if it has been programmed.

4.

EXECUTE / SIMULATE



CNC 8055
CNC 8055i

.T. MODEL
SOFT: V01.3x

The axes are moved at maximum feedrate allowed F0 regardless of the programmed F value and it can be varied using the feedrate override switch.

The simulation ignores the dwells programmed with G4.

RAPID [S=0]

It takes into account tool radius compensation (functions G41, G42) thus showing the graphic representation of the path for the theoretical tool nose.

It outputs to the PLC the rest of the functions M, S, T.

It does not output the M functions associated with the spindle when operating in open loop (rpm): M3, M4, M5, M41, M42, M43 and M44.

It outputs to the PLC the M function associated with spindle orientation (M19) when operating in closed loop.

It does not start the spindle.

The axes, "C" axis included, are moved at maximum feedrate F0 regardless of the programmed F value and it can be varied using the feedrate override switch.

The simulation ignores the dwells programmed with G4.

Execution or simulation conditions

The executing or simulating conditions (initial block, type of graphics, etc.) that may be set before or while executing or simulating a part-program are:

BLOCK SELECTION

It allows selecting the block in which the execution or the simulation of the program will start.

STOP CONDITION

It allows selecting the block in which the execution or the simulation of the program will stop.

DISPLAY

It allows the display mode to be selected.

MDI

It allows any type of block (ISO or high level) to be edited with programming assistance by means of softkeys.

Once a block has been edited and after pressing the [START] key, the CNC will execute this block without leaving this operating mode.

TOOL INSPECTION

Once the execution of the program has been interrupted, this option allows the tool to be inspected and changed should this be necessary.

GRAPHICS

This option carries out a graphic representation of the part during the execution or simulation of the selected part program. It also allows selecting the type of graphic, the area to be displayed, the viewpoint and graphic parameters.

SINGLE BLOCK

Allows the part program to be executed one block at a time or continuously.

4.

EXECUTE / SIMULATE

FAGOR 

**CNC 8055
CNC 8055i**

.T. MODEL
SOFT: V01.3x

4.1 Block search. Switching from simulation to execution

This feature solves a situation that occurred when interrupting a program that was being executed before it ended. The program may have been interrupted due to a "STOP-RESET", and emergency, a PLC/CNC error or because the CNC was turned off while executing a program or in a temporary stop.

The CNC remembers the program block at the time of the interruption that did not allow executing it completely.

The home search permits restoring the history of a program up to a particular block in such way that when resumed, it executes the rest of the program with the same conditions as it would if it were executed from the beginning.

Example: A part machining process is interrupted at any time. The block search may be used for positioning the tool in the same place it was just when the program was interrupted and in the same conditions.

Block search is executed from the execution mode using a menu driven operational process. The program execution will resume once the block search is done.

To access the block search, press the softkey <BLOCK SELECTION> of the softkey menu of the execution window.

4.

EXECUTE / SIMULATE
Block search. Switching from simulation to execution



CNC 8055
CNC 8055i

-T- MODEL
SOFT: V01.3x

4.1.1 Operating modes

Pressing <BLOCK SELECTION> displays a menu for selecting the starting block or the way to operate.

Starting block

Pressing the <FIRST BLOCK> softkey gives access to the menu for selecting the block from which to start executing the program.

FIRST LINE:

By pressing this key, the cursor will position at the first line of the program.

LAST LINE:

By pressing this key, the cursor will position at the last line of the program.

TEXT:

With this function it is possible to search for a text or character sequence starting at the current cursor position.

When this softkey is pressed, the CNC requests the character sequence to be found. Once this text has been keyed in, press the <END OF TEXT> softkey and the cursor will position over the first occurrence of the keyed text.

The search will begin from the block the cursor is position on beginning at that block. The text found will be highlighted being possible to continue with the search or to quit it.

Press [ENTER] to continue the search up to the end of the program. The CNC will begin the search at the last text found and it will highlight it.

The search can be done as many times as desired. Once searched to the end of the program, it will continue the search from the beginning.

Press the <ABORT> softkey or the [ESC] key to quit the search mode. When quitting the search mode, the cursor will be positioned at the last matching text found.

LINE NUMBER:

After pressing this softkey, the CNC will request the number of the line to be found. Once that number has been defined, pressing [ENTER] positions the cursor over the requested line.

4.

EXECUTE / SIMULATE

Block search. Switching from simulation to execution

FAGOR 

**CNC 8055
CNC 8055i**

.T. MODEL
SOFT: V01.3x

Searching blocks containing G functions. EXEC G search

When restoring the history of the program, the CNC reads it up to the set block activating and canceling the "G" functions that reads along. Likewise, it sets the feedrate and spindle speed conditions of the program and calculates the position where the axes should be.

The M, T and S functions are not output to the PLC, but they are memorized so when the last block is reached, the CNC shows a list of the conditions that the CNC must have assumed by the history.

Once the simulation is over, the user can restore the M, S, T functions:

- A. In the order in which the M, S, T functions were simulated by pressing < EXECUTE MST> and then [CYCLE START].
- B. Pressing the softkeys <TOOL INSPECTION>, <DISPLAY MST> and <MDI> in this order, the user can execute the desired blocks in any order he wishes.

The screen shows a list of the M, S and T functions (one per line and in simulation order) bearing the following in mind:

- It shows the M functions of the history bearing in mind that some M functions may cancel others.
- If there is a second spindle and M functions a programmed that refer to that spindle (M3, M4, M5, M19, M41-44), they will not cancel the ones equivalent to the first spindle. Also, when restoring these M functions, it first restores those of each programmed spindle G28 or G29.
- When it receives an OEM's M function and then it receives the same M function, the older one disappears from the list.
- It displays the last T function programmed as well as the last S function programmed.

Searching a block that contains G, M, S and T functions. EXEC GMST search

When restoring the history of the program, the CNC reads it up to the set block activating and canceling the G functions that reads along. Also, it sets the feedrate and spindle speed conditions of the program and calculates the position where the axes should be.

The M, S and T functions are executed and output to the PLC.



WARNING: This block searching method is less suitable than the previous one especially when not using safety mechanisms at the PLC. If the tool is not positioned correctly in the tool changes, it could cause collisions.

If in any of the two block searching methods the program that contains the searched block is stored in a hard disk, Ethernet or DNC, the bottom of the screen can display the line being simulated at that moment. This information gives an idea of how much is left to reach the block.

4.

EXECUTE / SIMULATE

Block search. Switching from simulation to execution



CNC 8055
CNC 8055i

-T- MODEL
SOFT: V01.3x

4.1.2 Automatic block search

It may be used to restore the program history up to the block where the execution was interrupted. The CNC remembers in which block the execution was interrupted, thus not being necessary to set the stop block.

If the program is interrupted inside an internal cycle, it will behave as follows:

If it is a pocket cycle (G66, G67, G68, G87, G88) or a multiple cycle (G60, G61, G62, G63, G64), when doing a home search, it restores the history up to the last subblock inside the completed cycle.

In the rest of the canned cycles (G69, G81, G82, G84, G85, G86), it is interrupted inside the cycle, it restores the history up to the cycle calling block.

To access the automatic block search, press <BLOCK SELECTION> and press one of the operating modes <EXEC G SEARCH> or <EXEC GMST SEARCH>.

Then, press the <STOP BLOCK> and <AUTOMATIC SEARCH> softkeys.

The <AUTOMATIC SEARCH> softkey is only shown when the block that has been stored for the automatic search is located among those of the program and once pressed places the cursor in that block.

Once the block has been selected, the screen shows the text STOP=HD:PxxxLxxx that indicates the location of the program, the program number and the program line. After pressing [CYCLE START] the CNC searches the block and once simulated up to the stop block, it removes the previous text.

Then, the CNC determines the axes that are out of position and shows them so they can be selected. If it has also searched for G functions and the program contains M, S, T functions that must be executed, the menu shows the softkey <PENDING MST EXEC> so those functions are executed after pressing the softkey and validating it with [CYCLE START].

Tool inspection:

Pressing the <TOOL INSPECTION.> accesses tool inspection.

- Pressing the <DIS PENDING MST> softkey displays the M, S and T functions that have been simulated and are pending to be executed.
- Pressing the <MDI> softkey access that mode and lets the user execute the desired blocks.

4.

EXECUTE / SIMULATE

Block search. Switching from simulation to execution

FAGOR 

**CNC 8055
CNC 8055i**

.T- MODEL
SOFT: V01.3x

4.1.3 Manual block search

It serves to restore the history of the program up to a block defined by the user:

- A. If it is a motion block, the program simulation stops once that block is completed.
- B. If it is a program flow changing block (GOTO, RPT, CALL, EXEC), the simulation stops in that block, but without jumping to the new block.
- C. If it is a positioning block that has a canned cycle or a subroutine or a modal program associated with it, the program simulation stops once the positioning is done leaving the execution of the canned cycle or modal subroutine for after repositioning.
- D. In the case of blocks calling upon irregular-pocket-with-islands cycle calling and TRACE, DIGIT or PROBE cycles, the program simulation stops in the calling block, but without simulating anything in that cycle.

To access the manual block search, press <BLOCK SELECTION> and press one of the operating modes <EXEC G SEARCH> or <EXEC GMST SEARCH>.

PROGRAM SELECTION:

This option will be used when the final execution or simulation block belongs to another program or to a subroutine resident in another program.

Pressing the <PROGRAM SELECTION> softkey opens an explorer-type window for selecting a program of any unit such as hard disk, DNC, DNCE.

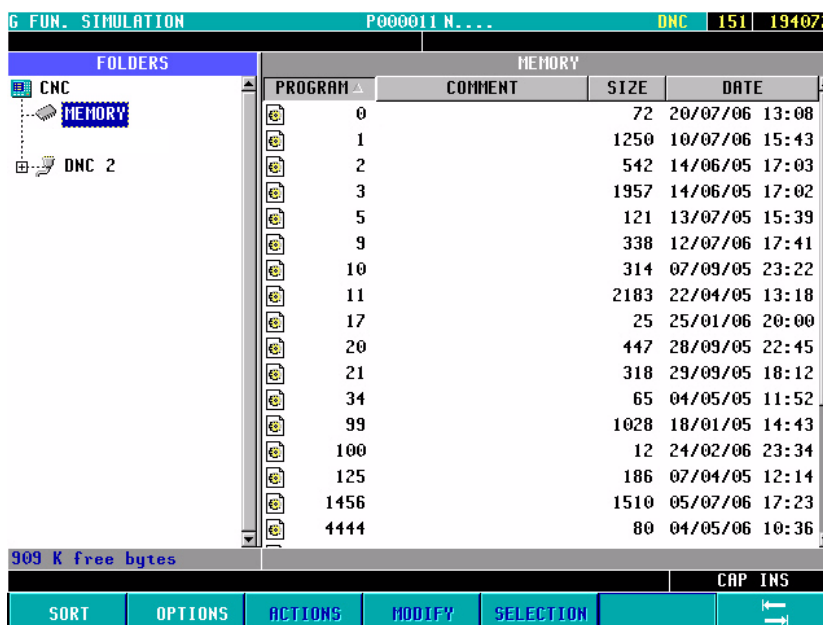

NUMBER OF TIMES

This function will be used to indicate that the execution or simulation of the selected program must stop after executing the "end block" several times.

When selecting this function, the CNC will request the number of times to be executed or simulated.

If the selected block has a number of block repetitions, the program will stop after doing all the repetitions indicated.

4.

EXECUTE / SIMULATE
Block search. Switching from simulation to execution



CNC 8055
CNC 8055i

-T- MODEL
SOFT: V01.3x

FIRST BLOCK

It sets as the first block for the block search the one selected with the cursor and validated with [ENTER]. When not setting the first block, the block search starts in the first block of the program.

The block to be selected may be found using the [UP ARROW], [DOWN ARROW], [PREV. PAGE], [NEXT PAGE] or the softkeys of the menu.

STOP BLOCK

To set the last block for restoring the program history up to that block, just select it with the cursor and press [ENTER]. When executing the program after that, it will start right from that block.

The block to be selected may be found using the [UP ARROW], [DOWN ARROW], [PREV. PAGE], [NEXT PAGE] or the softkeys of the menu.

Once a stop point has been selected, the screen shows the text STOP=HD:PxxxLxxx that indicates the location of the program, the program number and the program line. After pressing [CYCLE START] the CNC searches the block and once simulated up to the stop block, it removes the previous text.

Then, the CNC determines the axes that are out of position and shows them so they can be selected. If it has also searched for G functions and the program contains M, S, T functions that must be executed, the menu shows the softkey <PENDING MST EXEC> so those functions are executed after pressing the softkey and validating it with [CYCLE START].

Tool inspection:

Pressing the <TOOL INSPECTION.> accesses tool inspection.

- Pressing the <DIS PENDING MST> softkey displays the M, S and T functions that have been simulated and are pending to be executed.
- Pressing the <MDI> softkey access that mode and lets the user execute the desired blocks.

4.

EXECUTE / SIMULATE

Block search. Switching from simulation to execution



**CNC 8055
CNC 8055i**

.T. MODEL
Soft: V01.3x

4.1.4 Home searching restrictions

Block search is restricted in the following scenarios:

- In a program where a particular scaling factor is activated, the block search is automatically or manually restricted to a block after that activation.
- In a program where axes are slaved with G77 or using PLC SYNCRO marks, the block search is automatically or manually restricted to a later block.

The same restriction applies to a program having spindle synchronization.

- In a program that applies mirror image via PLC using MIRROR marks, the automatic or manual search are restricted to later blocks.
- In a program containing a home search (G74), the automatic or the manual search is restricted to later blocks.

4.1.5 Disabling the simulation and block search modes

The simulation and block search modes are available depending on the setting of g.m.p. DISSIMUL (P184).

4.

EXECUTE / SIMULATE

Block search. Switching from simulation to execution



CNC 8055
CNC 8055i

-T- MODEL
SOFT: V01.3x

4.2 Display

With this option, it is possible to select the most appropriate display mode at any time even during execution or simulation of a part program.

The display modes available at the CNC and which can be selected with softkeys are:

- STANDARD display mode.
- POSITION display mode.
- PART-PROGRAM display.
- SUBROUTINES display mode.
- FOLLOWING ERROR display mode.
- USER display mode.
- EXECUTION TIME display mode.

All the display modes have a window at the bottom of the CRT which shows the history with the conditions in which machining is being done. The information shown is as follows:

F and %	Programmed feedrate (F) and selected feedrate override %. When feed-hold is active, the feedrate value is shown in reverse video (highlighted).
S and %	Programmed spindle speed (S) and override % of the selected spindle speed.
T	Number of active tool.
D	Number of active tool offset.
S RPM	Real spindle speed. It is given in rpm. When working in M19 this indicates the position of the spindle. It is given in degrees.
S M/MIN	Real spindle speed. It is given in meters per minute.
G	All displayable G functions that are active.
M	All displayable M functions that are selected.
PARTC	Parts counter. It indicates the number of consecutive parts executed with the same part-program. Every time a new program is selected, this variable is reset to "0". With this CNC variable "PARTC" it is possible to modify this counter from the PLC, from the CNC program and via DNC.
CYTIME	Indicates the time elapsed while executing the part. It is given in "hours : minutes : seconds : hundredths of a second". Every time a part-program execution starts, even when repetitive, this variable is reset to "0".
TIMER	Indicates the count of the timer enabled by PLC. It is given in "hours : minutes : seconds".

4.

EXECUTE / SIMULATE
DisplayFAGOR CNC 8055
CNC 8055i-T- MODEL
SOFT: V01.3x

4.2.1 Standard display mode

The CNC assumes this display mode on power-up and after pressing [SHIFT]+[RESET].

It shows the following fields or windows:

4.
EXECUTE / SIMULATE
 Display

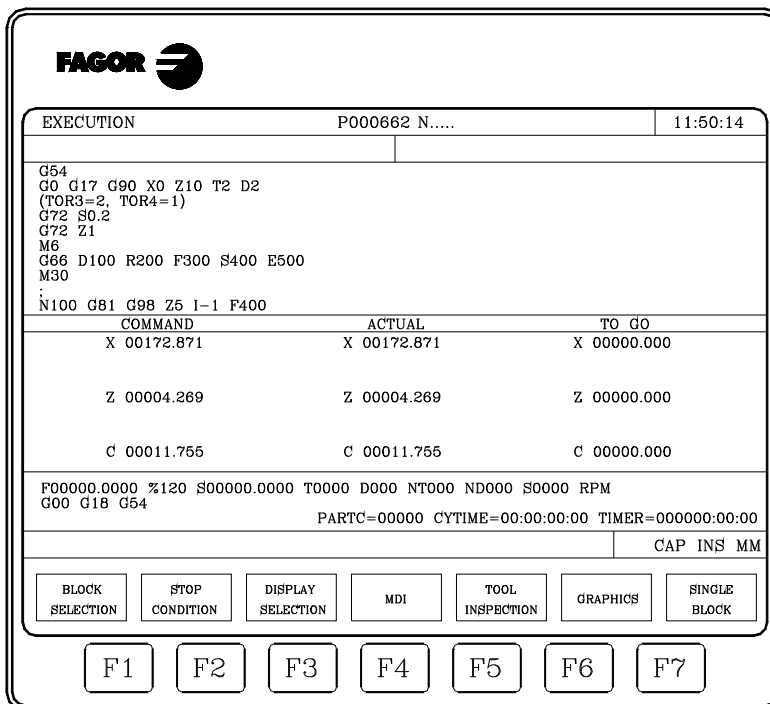

- A group of program blocks. The first of them is the block being executed.
- The position values for the axes of the machine.

It must be borne in mind that the display format for the axes is established by machine parameter "DFORMAT" and that real or theoretical position values will be shown depending on the setting of machine parameter "THEODPLY".

Each axis is provided with the following fields:

- COMMAND** Indicates the programmed coordinate or position value which the axis must reach.
- ACTUAL** Indicates the actual (current) position of the axis.
- TO GO** Indicates the distance which is left to run to the programmed coordinate.



CNC 8055
CNC 8055i

.T. MODEL
SOFT: V01.3x

4.2.2 Position display mode

This display mode shows the position values of the axes.

This display mode shows the following fields or windows:

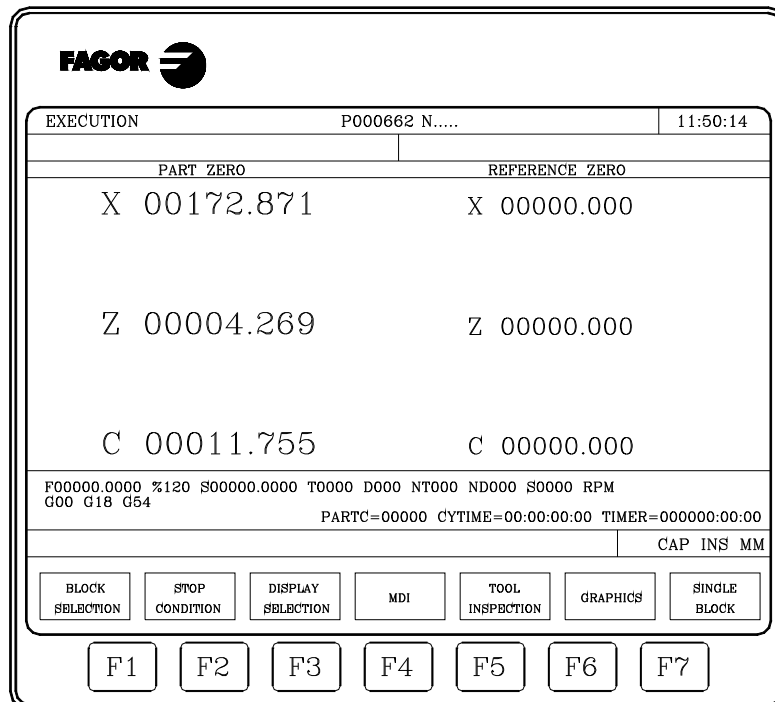

- The real position values for the axes that indicate the current position of the machine. It must be borne in mind that the display format for the axes is established by machine parameter "DFORMAT" and that real or theoretical position values will be shown depending on the setting of machine parameter "THEODPLY".
When the C axis is active, the position of the X-C axes referred to part zero correspond to the transformed coordinates.
Each axis is provided with the following fields:
PART ZERO This field shows the real axis position with respect to part zero.
MACHINE ZERO This field shows the real axis position with the respect to machine reference zero (home).

4.2.3 Part-program display

Displays a page of program blocks among which the block being executed is highlighted.

4.

EXECUTE / SIMULATE
Display



CNC 8055
CNC 8055i

.T. MODEL
SOFT: V01.3x

4.2.4 Subroutine display mode

This display mode shows information regarding the following commands:

- (RPT N10, N20) This function executes the program section between blocks N10 thru N20.
- (CALL 25) This function executes subroutine number 25.
- G87 ... This function the corresponding canned cycle.
- (PCALL 30) This function executes subroutine 30 in a local parameter level.

When this mode is selected, the following must be considered:

- At this CNC, it is possible to define and use subroutines that can be called from the main program, or from another subroutine, it also being possible to call a second subroutine, from the second to a third, etc. The CNC limits these calls to a maximum of 15 nesting levels.
- The CNC generates a new nesting level of local parameters every time parameters are assigned to a subroutine. Up to a maximum of 6 nesting levels of local parameters are possible.
- The machining canned cycles G81 thru G89 use the sixth nesting level for local parameters when they are active.

This display mode shows the following fields or windows:

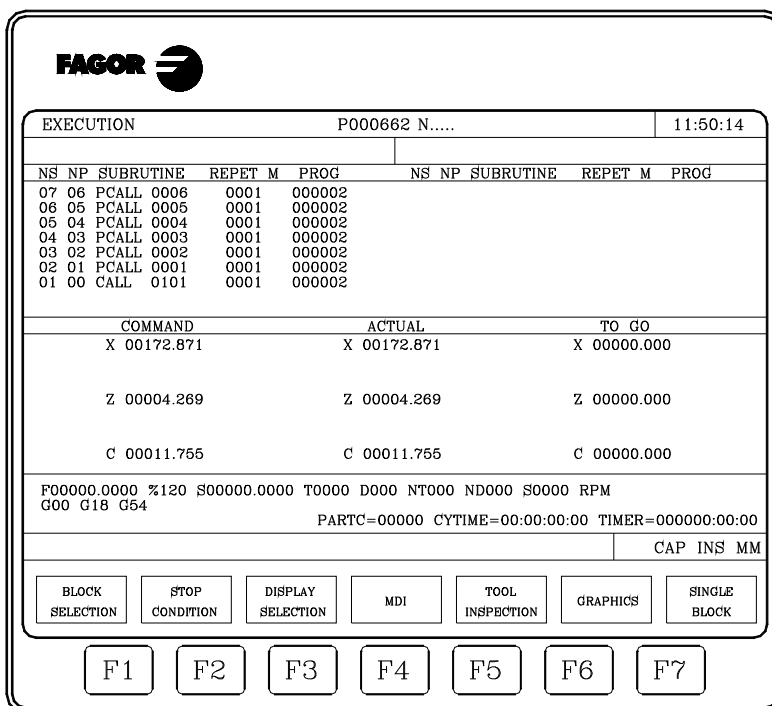

- A display area that shows the following information on the subroutines that are active.
 - NS Indicates the nesting level (1-15) which the subroutine occupies.
 - NP Indicates the level of local parameters (1-6) in which the subroutine is executed.
 - SUBROUTINE Indicates the type of block which has caused a new nesting level.
Examples: (RPT N10, N20) (CALL 25) (PCALL 30) G87
 - REPT Indicates the number of times that remain to be executed.
For example, if (RPT N10, N20) N4 is programmed and is the first time that it is being executed, this parameter will show a value of 4.
 - M If an asterisk is shown (*) this indicates that a Modal subroutine is active in this nesting level, and this is executed after each movement.
 - PROG Indicates the program number where the subroutine is defined.

- The position values for the axes of the machine.
It must be borne in mind that the display format for the axes is established by machine parameter "DFORMAT" and that real or theoretical position values will be shown depending on the setting of machine parameter "THEODPLY".

Each axis is provided with the following fields:

COMMAND	Indicates the programmed coordinate or position value which the axis must reach.
ACTUAL	Indicates the actual (current) position of the axis.
TO GO	Indicates the distance which is left to run to the programmed coordinate.

4.

EXECUTE / SIMULATE
Display

FAGOR 

CNC 8055
CNC 8055i

.T. MODEL
SOFT: V01.3x

4.2.5 Following error display mode

This display mode shows the following error (difference between the theoretical value and the real value of their position) of the axes and the spindle.

4.
EXECUTE / SIMULATE
Display

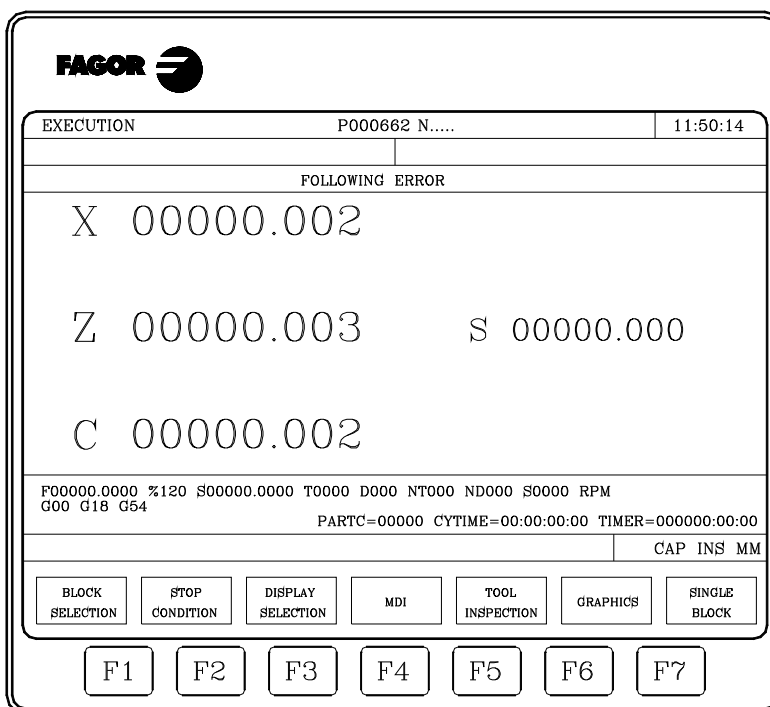

The display format is determined by the axis machine parameter "DFORMAT".

When executing a rigid tapping, the offset between the spindle and the longitudinal axis appears below the following error of the spindle. The displayed value corresponds with that of the "RIGIER" variable.

The offset value during rigid tapping is only displayed while tapping is in progress. Once the tapping is completed, the data will disappear.

4.2.6 User display mode

This option will execute the program that is selected by means of the general machine parameter "USERDPLY" in the user channel.

To quit its execution and return to the previous menu, press [ESC].



CNC 8055
CNC 8055i

.T. MODEL
SOFT: V01.3x

4.2.7 Execution time display mode

This option is available while simulating a part-program and it will display the following fields or windows:

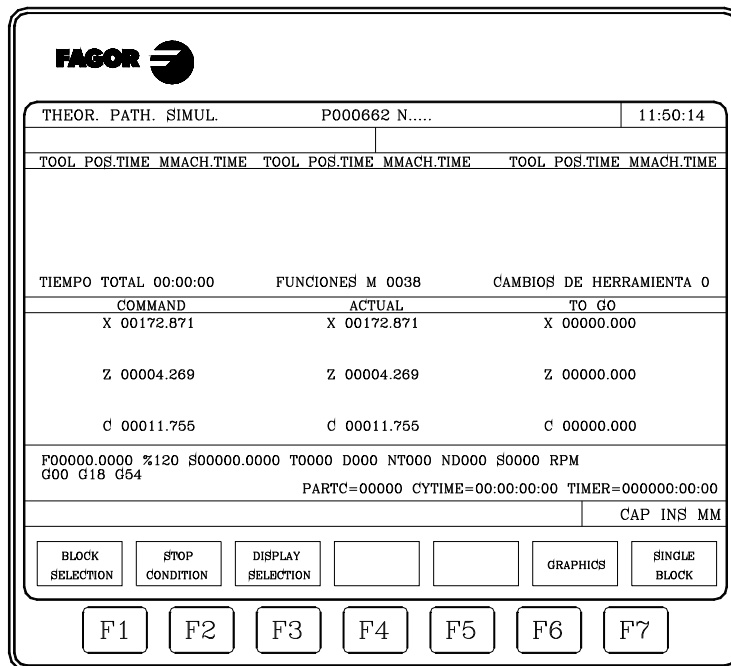

- A display window shows the estimated program execution time at 100% of the programmed feedrate. This display area shows the following information:
 - The time each tool (TOOL) takes to execute the positioning moves (POS.TIME) as well as the machining moves (MACH.TIME) indicated in the program.
 - The total time required to execute the complete program.
 - The M functions being executed in the program.
 - The number of tool changes performed during the execution of the program.
- The position values for the axes of the machine.

It must be borne in mind that the display format for the axes is established by machine parameter "DIFORMAT" and that real or theoretical position values will be shown depending on the setting of machine parameter "THEODPLY".

Each axis is provided with the following fields:

 - COMMAND** Indicates the programmed coordinate or position value which the axis must reach.
 - ACTUAL** Indicates the actual (current) position of the axis.
 - TO GO** Indicates the distance which is left to run to the programmed coordinate.

4.

EXECUTE / SIMULATE
Display



CNC 8055
CNC 8055i

.T- MODEL
SOFT: V01.3x

4.3 MDI

This function is not available in the "program simulation" mode. Besides, if a program is being executed, it must be interrupted in order to access this function.

It is possible to execute any block (ISO or high level) and it provides information on the corresponding format via the softkeys.



Once a block has been edited and after pressing the [START] key, the CNC will execute this block without leaving this operating mode.

History of executed blocks.

From the MDI mode, pressing the [▲] or [▼] key will open a window that shows the last 10 instructions that have been executed. This window resizes itself to fit the number of instructions that have been saved. To execute or modify an MDI line that has been executed earlier, proceed as follows:

1. Open the window that shows the last MDI instructions:
 - If the cursor is at the beginning of the line, press [▲]. Pressing [▼] moves the cursor to the end of the line.
 - If the cursor is at the end of the line, press [▼]. Pressing [▲] moves the cursor to the beginning of the line.
 - If the cursor is neither at the beginning nor at the end of the line, both keys [▲] and [▼] open the window that shows the last MDI instructions.
2. Use the [▲] or [▼] key to select the desired instruction.
 - Press [START] to execute the selected instruction.
 - Press [ENTER] to modify the selected instruction. Once the instruction has been modified, press [START] to execute it.

An MDI instruction is saved only if it is correct and if it is not the same as the previous one on the list. The instructions are kept saved even after turning the unit off.

4.

EXECUTE / SIMULATE
MDI

CNC 8055
CNC 8055i

-T- MODEL
SOFT: V01.3x

4.4 Tool inspection

This function is not available in the "program simulation" mode. Besides, if a program is being executed, it must be interrupted in order to access this function.

This operating mode allows all the machine movements to be controlled manually, and enabling the axis control keys on the operator panel. Also, the CNC will show the softkeys to access the CNC tables, edit and execute a block in MDI as well as repositioning the axes of the machine to the position from where this function was called.

One of the ways to make the tool change is as follows:

1. Move the tool to the required tool change position.
This move may be made by jogging the axes from the operator panel or in MDI.
2. Gain access to CNC tables (tools, Tool offsets, etc.) in order to find another tool with the similar characteristics.
3. Select, in MDI, the new tool as the active one.
4. Make the tool change
This operation will be performed depending on the type of tool changer used. It is possible to execute the tool change in MDI in this step.
5. Return the axes to the position where the tool inspection began (REPOSITIONING).
6. Continue executing the program, pressing the [START] key.

If during tool inspection, the spindle is stopped, the CNC will restart it in the same turning direction (M3 or M4) while repositioning.

The CNC offers the following options by means of softkeys:

"MDI" softkey

Allows to edit blocks in ISO or high level (except those associated with subroutines) providing information on the corresponding format by means of softkeys.



Once a block has been edited and after pressing the [START] key, the CNC will execute this block without leaving this operating mode.

History of executed blocks.

From the MDI mode, pressing the [↑] or [↓] key will open a window that shows the last 10 instructions that have been executed. This window resizes itself to fit the number of instructions that have been saved. To execute or modify an MDI line that has been executed earlier, proceed as follows:

1. Open the window that shows the last MDI instructions:
 - If the cursor is at the beginning of the line, press [↑]. Pressing [↓] moves the cursor to the end of the line.
 - If the cursor is at the end of the line, press [↓]. Pressing [↑] moves the cursor to the beginning of the line.
 - If the cursor is neither at the beginning nor at the end of the line, both keys [↑] and [↓] open the window that shows the last MDI instructions.
2. Use the [↑] or [↓] key to select the desired instruction.
 - Press [START] to execute the selected instruction.
 - Press [ENTER] to modify the selected instruction. Once the instruction has been modified, press [START] to execute it.

An MDI instruction is saved only if it is correct and if it is not the same as the previous one on the list. The instructions are kept saved even after turning the unit off.

"TABLES" softkey

Allows access to any of the CNC tables associated with part programs (zero offsets, tool offsets, tools, tool magazine and parameters).

4.

EXECUTE / SIMULATE
Tool inspection

FAGOR 

CNC 8055
CNC 8055i

-T- MODEL
SOFT: V01.3X

Once the desired table has been selected, all editing commands will be available for its verification and modification.

Press the [ESC] key to return to the previous menu (tool inspection).

"REPOSITIONING" softkey

The user can do a repositioning after a tool inspection.

The repositioning mode is selected using g.m.p. REPOSTY (P181).

Basic repositioning mode:

When selecting this option, the CNC lets position all the axes at the point where tool inspection started.



To do this, select one of the following softkeys and press [START] for the CNC to reposition the axes.

- | | |
|---------|--|
| [PLANE] | It moves the X and Z axes at the same time. |
| [X-Z] | It moves first the X axis and then the Z axis. |
| [Z-X] | It moves first the Z axis and then the X axis. |

Extended repositioning mode:

With the extended repositioning mode, pressing the [REPOSITIONING] softkey displays a softkey menu to carry out the following operations:

- If there is a pending spindle movement (M3, M4, M5, M19), it shows a spindle softkey showing this previous status and the pending function.
After pressing the displayed softkey and then [CYCLE START], the CNC generates a block that resumes the spindle movement before the inspection.
If the spindle position changes while being in M19, it considers that there has been a change and it shows the softkey.
- When selecting an axis with the relevant softkey and pressing [CYCLE START], the CNC generates a motion block up to the repositioning coordinate for that axis.
Several axes may be moved at the same time, but it is not possible to select the movement of the axes and of the spindle at the same time.
- The repositioning movement of one or several axes may be interrupted and it is possible to inspect and reposition as often as desired.
- Using the manual repositioning mode, the CNC lets move the axes with the electronic handwheels or with JOG keypad both continuously and in incrementally. The movement of the axes is restricted by the repositioning end point and the corresponding software travel limit.
The handwheel movements will not be restricted by the repositioning points.
- When an axis reaches the last repositioning point, it is no longer available and cannot be jogged. To move that axis, switch to tool inspection mode.
- The [END REPOSITIONING] softkey may be used to exit the repositioning mode and press [CYCLE START] to resume program execution.
If after quitting the repositioning mode, the axes are not properly repositioned, the CNC will move the axes from where they are to the repositioning point.
- The [TOOL INSPECTION] softkey may be used to return to the tool inspection mode where the axes may be jogged continuously, incrementally or with an electronic handwheel. In this case, the movements are only limited by the software travel limits.

Besides, it is possible to switch to MDI mode to execute simple blocks.

4.

EXECUTE / SIMULATE
Tool inspectionCNC 8055
CNC 8055i-T- MODEL
SOFT: V01.3x

"MODIFY OFFSETS" softkey

This option shows (at the top) a help graphic and the tool fields that can be edited. The data may be selected with the [←] [→] [↑] [↓] keys or from the softkey menu.

It is also possible to select a new tool to correct it. To select a new tool, enter its number in the T field and press [ENTER].

- The I and K values may be modified for the active tool. To assume the new values, select the tool again.
- The I, K and D values may be modified if it is not the active tool.

The values entered in the I - K fields are incremental; they are added to the ones already in the table. The "I" data is given in diameter.

The maximum value that may be entered in each I - K field is limited by machine parameters MAXOFFI and MAXOFFK. When trying to enter a greater value, the relevant message will be displayed.

4.**EXECUTE / SIMULATE**
Tool inspection**FAGOR** **CNC 8055**
CNC 8055i-T- MODEL
SOFT: V01.3x

4.5 Graphics

With this function it is possible to select the type of graphic to be used as well as to define all the parameters for the corresponding graphic display.

To do so, the CNC must NOT be executing or simulating a part program; otherwise, it must be interrupted.

Once the type of graphics has been selected and its parameters defined, this function can be accessed even during the execution or simulation of a part program should the type of graphic or any graphic parameters be changed. In this case, the CNC shows the graphic representation for the part being executed or simulated and the part-program must be interrupted in order to change the type of graphics or to modify any of the graphic parameters.

After selecting this function, the CNC will display the following softkey options:

- Type of graphic.
- Display area.
- Zoom.
- Graphic parameters.
- Clear Screen.
- Deactivate graphics.

4.**EXECUTE / SIMULATE**

Graphics



CNC 8055
CNC 8055i

·T· MODEL
SOFT: V01.3x

4.5.1 Type of graphic

The CNC has two types of graphics:

- Line graphics XZ, XC and ZC.
- Solid graphics SOLID XZ, SOLID XC and SOLID ZC.

Select one of all the available CNC options shown by softkeys.

The selected type of graphics will remain active until a different type is selected, until graphics are deactivated (there is a "DEACTIVATE" option) or until the CNC is turned off.

Every time a type of graphics is selected, all the graphic conditions (zoom, graphic parameters and display area) used last will be recovered. These conditions remain even after turning the CNC off and back on.

The coordinate system used in the graphic display is determined by the general machine parameter "GRAPHICS".

The type of graphic selected will appear to the right of the screen with the following information:

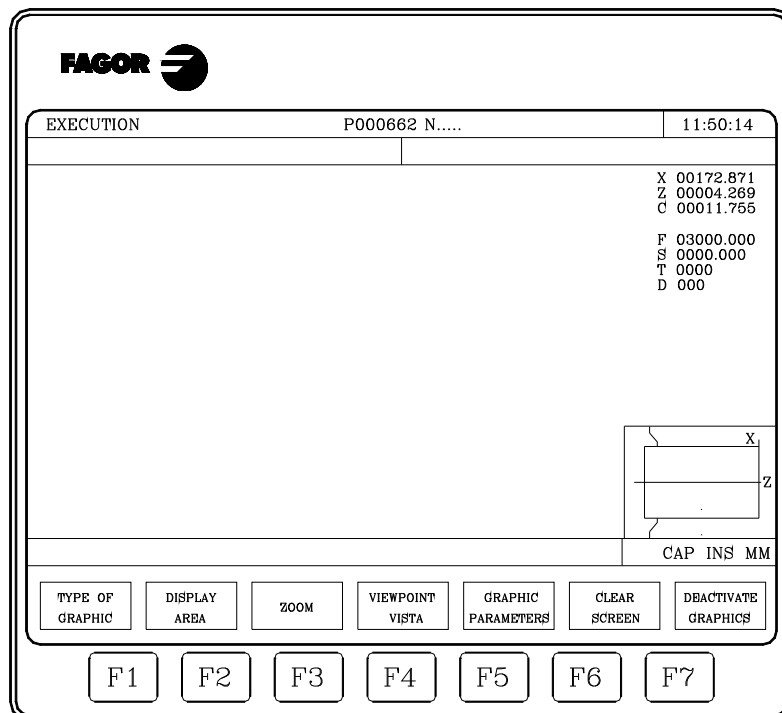

- The theoretical cutter's point coordinates (X,Z)
- The feedrate of the axes (F) and the spindle speed (S) currently selected.
- The tool (T) and offset (D) currently active.
- The coordinate system used in the graphic display which corresponds to the one set at general machine parameter "GRAPHICS".
- A clamped part with a superimposed window.

The part shows the size of the display area and the superimposed window represents the area actually selected for the graphic display.

LINE GRAPHICS XZ, XC, ZC

This type of graphics draws with colored lines the movement of the tool on the selected planes (XZ, XC, ZC).

The graphic generated after the execution or simulation of a program will be lost in the following cases:

- When deleting the screen ("CLEAR SCREEN" softkey)
- When deactivating the graphics ("DEACTIVATE GRAPHICS" softkey).
- When selecting another type of solid graphics (solid XZ, solid XC, solid ZC).

SOLID GRAPHICS

The types of solid graphics available are (solid XZ, solid XC, solid ZC).

This type of graphics shows the part secured at the spindle and the tool in use. Depending on whether the program is being executed or simulated, the programmed tool movement will be shown as well as the shape of the part after that operation.

If during the execution or simulation of a program, no tool is selected, the CNC will NOT show the tool and the shape of the part will be shown intact.

In XZ SOLID, when an "S" spindle speed is assigned, the resulting part will be shown machined (turned) on both sides. On the other hand, if no "S" is programmed, the resulting part will only be shown machined on the tool side.

The generated graphic will be lost in the following cases:

- When deleting the screen ("CLEAR SCREEN" softkey)
- When deactivating the graphics ("DEACTIVATE GRAPHICS" softkey).
- When selecting another type of line graphics (XZ, XC, ZC).

4.

EXECUTE / SIMULATE
Graphics

CNC 8055
CNC 8055i

-T- MODEL
SOFT: V01.3x

4.5.2 Display area

In order to use this function, no part program may be in execution or simulation. If this is the case, it must be interrupted.

With this option it is possible to re-define the display area by assigning new maximum and minimum values for the Z axis and for the part radius (X axis). These position values are referred to part zero.

In order to re-define the display area, the CNC will show, to the right of the screen, several windows indicating the current display area dimensions.

Use the [↑] [↓] keys to select the window whose value is to be changed and key in the new value.

Once all the desired windows have been assigned new values, press [ENTER] to validate them.

To quit this mode without making any changes, press [ESC].

In line graphics (XZ, XC, ZC) there is a softkey [optimum area] which redefines the display area that contains, in all planes, all the tool paths already executed.

Every time a new display area is defined, it redraws the machining executed up to that point. If the number of points to be redrawn exceeds the amount of memory reserved for it, only the last points will be redrawn and the older ones will be lost.

4.

EXECUTE / SIMULATE
Graphics

FAGOR 

CNC 8055
CNC 8055i

.T. MODEL
SOFT: V01.3x

4.5.3 Zoom

In order to use this function, no part program may be in execution or simulation. If this is the case, it must be interrupted.

With this option, it is possible to enlarge or reduce the graphics display area.

When selecting this option, the CNC will show a window superimposed on the current graphics and another one over the drawing at the lower right-hand side of the screen. These new windows indicate the new display area being selected.

Use the softkeys [zoom +], [zoom-] and the keys [+], [-] to either enlarge or reduce the size of the new display area and the [↑] [↓] [←] [→] keys to move the zoom window around to the desired location on the screen.

The "initial value" softkey assumes the values set with this softkey "display area" The CNC shows that value, but does not quit the ZOOM function.

Once the new display area has been defined, press [ENTER] to validate the new values.

To quit this mode without making any changes, press [ESC].

Every time a zoom is carried out, it redraws the machining executed up to that point. If the number of points to be redrawn exceeds the amount of memory reserved for it, only the last points will be redrawn and the older ones will be lost.

4.

EXECUTE / SIMULATE
Graphics

CNC 8055
CNC 8055i

-T- MODEL
SOFT: V01.3x

4.5.4 Graphic parameters

This function can be used any time, even during part program execution or simulation:

With this function it is possible to modify the simulation speed and the colors used to draw the tool paths.

The modifications made to any parameter are immediately assumed by the CNC and can be made during the execution or simulation of the part program.

The softkey options displayed by the CNC are:

SIMULATION SPEED

With this option it is possible to modify the feedrate percentage used by the CNC to execute the part programs in the simulation modes. The selected value will be kept until modified by another value or resetting the CNC.

The CNC will display a window at the top right-hand side of the screen indicating the current % of simulation speed.

That value will be modified with the [←] [→] keys. Once the desired value is selected, press [ENTER] to validate the new value. Press [ESC] to quit this function without making any changes to this field.

It is also possible to change the simulation speed while it is redrawing after a zoom. This lets you check the machining of a particular operation.

PATH COLORS

This option is used to change the colors used in the graphic representation. They can only be used in line graphics XZ. There are the following parameters:

- The color to draw the rapid traverse.
- The color to draw the theoretical path.
- The color to draw the compensated path.
- The color to draw the threading.

In order to re-define the display area, the CNC will show, to the right of the screen, several windows indicating the currently selected colors.

Among the various colors to choose from, there is a black or "transparent" one. If this one is chosen for a particular path, this path will not be displayed on the screen.

Use the [↑] [↓] keys to select the window and once selected, modify it using the [←] [→] keys.

Once the desired colors have been selected, press [ENTER] to validate the new choices or ESC to ignore the changes and leave this function with the original values intact. Press [ESC] to quit this function without making any changes to this field.

4.

EXECUTE / SIMULATE
GraphicsFAGOR CNC 8055
CNC 8055i-T- MODEL
SOFT: V01.3x

COLORS OF SOLID

With this option it is possible to modify the colors used to draw the solid. They can only be used in SOLID graphics. There are the following parameters:

- Color for the cutter.
- Color for the part.
- Color for the axes.
- Color for the clamps.
- The color to draw the internal Y side, machined side.
- The color to draw the internal Z side, machine side.

In order to re-define the display area, the CNC will show, to the right of the screen, several windows indicating the currently selected colors.

Among the various colors offered, it is also possible to select "black". If this color is selected to draw the part, none of the machining operations will be shown.

Use the [↑] [↓] keys to select the window and once selected, modify it using the [←] [→] keys.

Once the desired colors have been selected, press [ENTER] to validate the new choices or ESC to ignore the changes and leave this function with the original values intact. Press [ESC] to quit this function without making any changes to this field.

4.**EXECUTE / SIMULATE**
Graphics

CNC 8055
CNC 8055i

·T· MODEL
SOFT: V01.3x

4.5.5 Clear screen

In order to use this function, no part program may be in execution or simulation. If this is the case, it must be interrupted.

This function erases the screen or graphic representation shown.

When the solid graphic type is selected, the graphic representation will be reset and it will return to its initial state without machining.

4.

EXECUTE / SIMULATE
Graphics

FAGOR 

CNC 8055
CNC 8055i

.T. MODEL
SOFT: V01.3x

4.5.6 Deactivate graphics

This function can be used any time, even during part program execution or simulation:

It turns the graphics off.

To activate this function again, press the "GRAPHICS" softkey again. To do so, the CNC must NOT be executing or simulating a part program; otherwise, it must be interrupted.

Also, it will recover all the previous graphic conditions (type of graphics, zoom, graphic parameters and display area) used last.

4.**EXECUTE / SIMULATE**

Graphics



CNC 8055
CNC 8055i

·T· MODEL
SOFT: V01.3x

4.5.7 Measurement

To use this function, a line graphics (planes XZ, XC or ZC) must be selected and the CNC must not be executing or simulating the part-program. If this is the case, it must be interrupted.

Once this function is selected, the CNC shows the following information on the screen:

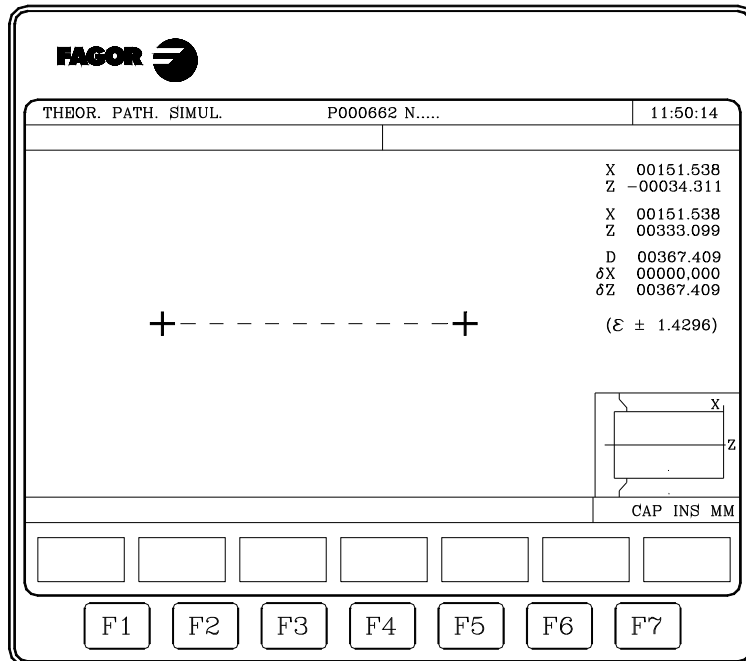

The center of the CRT shows a dotted line with two cursors, the section to be measured. Also, the right-hand side of the screen shows:

- The coordinates of those two cursors with respect to part-zero.
- The distance "D" between them and the components of this distance along the axes of the selected plane "δX" and "δZ".
- The cursor step "ε" corresponding to the selected display area. It is given in the work units, millimeters or inches.

The CNC shows the selected cursor and its coordinates in red.

To select the other cursor, press the [+] or [-] key. The CNC shows the new selected cursor and its coordinates in red.

Use the [↑] [↓] [←] [→] keys to move the selected cursor.

Likewise, the cursor may be moved to the indicated end using the keystroke combinations [SHIFT]+[↑], [SHIFT]+[↓], [SHIFT]+[←], [SHIFT]+[→].

To quit this command and return to the graphics menu, press [ESC].



Also, if [START] is pressed, the CNC exits this work mode and returns to the graphics menu.

4.

EXECUTE / SIMULATE
Graphics



CNC 8055
CNC 8055i

-T- MODEL
SOFT: V01.3X

4.6 Single block

When actuating on this option, the CNC toggles between single block mode and continuous run mode. The mode may be changed even while executing or simulation the program.



If the single block mode is selected, the CNC will only execute one line of the program every time [START] is pressed.

The upper window of the screen will show the selected mode of operation. If continuous execution, no message will appear and if SINGLE BLOCK, it will display the message:

4.

EXECUTE / SIMULATE

Single block



CNC 8055
CNC 8055i

·T· MODEL
SOFT: V01.3x

This operating mode will be used to edit, modify or look at a part-program stored in the CNC's RAM memory, in the hard disk (KeyCF) or in a remote disk.

To edit a program stored in a USB disk, it must be previously copied into RAM memory.

To edit a part-program, enter the program number (up to 6 digits) from the keyboard or by selecting it with the cursor from the CNC's part-program directory and then pressing [ENTER]. Move the cursor line by line using the [▲] [▼] keys or page by page using the Page-up and Page-down keys.

Once the program number has been entered, the CNC will display the softkeys for the following options:

EDIT	To edit new lines in the selected program.
MODIFY	To modify an existing line of the program.
FIND	To search a string of characters within a program.
REPLACE	To replace a string of characters with another.
DELETE BLOCK	With this function it is possible to delete a block or group of blocks.
MOVE BLOCK	To move a block or group of blocks within a program.
COPY BLOCK	To copy a block or group of blocks to another program position.
COPY TO PROGRAM	To copy a block or group of blocks into a different program.
INCLUDE PROGRAM	With this option it is possible to include or merge the contents of another program into the one currently selected.
EDITOR PARAMETERS	To select the editing parameters (automatic numbering and axes for Teach-in editing).

5.1 Edit

With this option it is possible to edit new lines or blocks of the selected program.

Select with the cursor the block after which the new ones will be added and press the softkey corresponding to one of the available editing modes.

CNC LANGUAGE

The program is edited in ISO code or high level language.

See "[5.1.1 Editing in CNC language](#)" on page 83.

TEACH-IN

The machine is jogged to the desired position and, then, the new axis position may be assigned to the block.

See "[5.1.2 TEACH-IN editing](#)" on page 84.

INTERACTIVE

Editing mode assisted by the CNC.

See "[5.1.3 Interactive editor](#)" on page 85.

PROFILES

To edit a new profile.

After defining the known profile data, the CNC generates its corresponding ISO-coded program.

See "[5.1.4 Profile editor](#)" on page 86.

PROFILE SELECTION

To modify an existing profile.

The CNC requests the first and last blocks of the profile. Once they are both defined, the CNC will show the corresponding graphics.

USER

When selecting this option, the CNC will execute, in the user channel, the customizing program selected by general machine parameter "USEREDIT".

5.

EDIT
Edit



CNC 8055
CNC 8055i

-T- MODEL
SOFT: V01.3x

5.1.1 Editing in CNC language

A program will be edited block by block and each block can be written either in ISO code or high level language or it can be just a program comment.

Once this option has been selected, the softkeys will change colors and they will appear over white background showing the information corresponding to the type of editing possible at that point.

Also, editing help will be available at any time by just pressing the [HELP] key. To quit this help mode, press [HELP] again.

If [ESC] is pressed while editing a block, the block editing mode is abandoned and the block currently being edited will not be added to the program.

Once the block has been edited, press [ENTER]. This new block will be added to the program after the one indicated by the cursor.

The cursor will position over the new edited block and the editing area (window) will be cleared so another block can be written.

To quit the block editing mode, press [ESC] or [MAIN MENU].

5.

EDIT
Edit

FAGOR 

CNC 8055
CNC 8055i

-T- MODEL
SOFT: V01.3x

5.1.2 TEACH-IN editing

It is basically the same as the previous option (editing in CNC language), except when it comes to programming coordinates.

This option shows the current position values of each one of the axes of the machine.

It permits to enter the axes position values from the CNC keyboard (as when editing in CNC language) or, also, use the TEACH-IN editing format as described next.

1. Jog the machine axes with the jogging keys or with the electronic handwheel up to the desired position.
2. Press the softkey corresponding to the axis to be defined.
3. The CNC will assign to this axis its current physical position as the program position value.

Both editing coordinate defining methods may be used indistinctly, even while defining a block.

When the block being edited has no information (editing area empty), the [ENTER] key can be pressed. In this case, the CNC will generate a new block with the current position values of all the axes of the machine.

This block will be added automatically to the program and it will be inserted after the block indicated by the cursor.

The cursor will position over the new edited block and the editing area (window) will be cleared so another block can be written.

When the position values of all the axes are not to be programmed in this fashion, the CNC permits to select the desired axes. To do this, in this operating mode and within the "EDITOR PARAMETERS" option there is a softkey for "TEACH-IN AXES"

Execution of the edited block

When editing a program in TEACH-IN mode, It will be possible to execute the block just edited.

Once the desired block has been edited, press [START] to execute that block. Once the block has been executed, press [ENTER] to enter it in the program or [ESC] not to.

An example of application may be to create a roughing program to machine a large part while roughing the part with MDI movements.



CNC 8055
CNC 8055i

-T- MODEL
SOFT: V01.3x

5.1.3 Interactive editor

This editor leads the operator through the program editing process by means of questions he/she will answer.

This kind of editing offers the following advantages:

- There is no need to know the CNC programming language.
- The CNC only lets entering the data being requested, thus avoiding any data entry errors.
- The programmer is assisted at all times with help screens or messages.

When selecting this option, the CNC displays in the main window, a series of graphic options selectable by softkey.

If the selected option has more menus, the CNC will keep showing new graphic options until the desired one is selected.

From this moment, the information corresponding to this option will appear in the main window and it will start requesting the data necessary to program it.

As the requested data is entered, the editing window will show, in CNC language, the block being edited.

The CNC will generate all necessary blocks and it will add them to the program once the editing of this option is done and it will insert them after the one indicated by the cursor.

The main window will show again the graphic options corresponding to the main menu being possible to continue editing the program.



CNC 8055
CNC 8055i

.T. MODEL
SOFT: V01.3x

5.1.4 Profile editor

The profile editor looks like this.

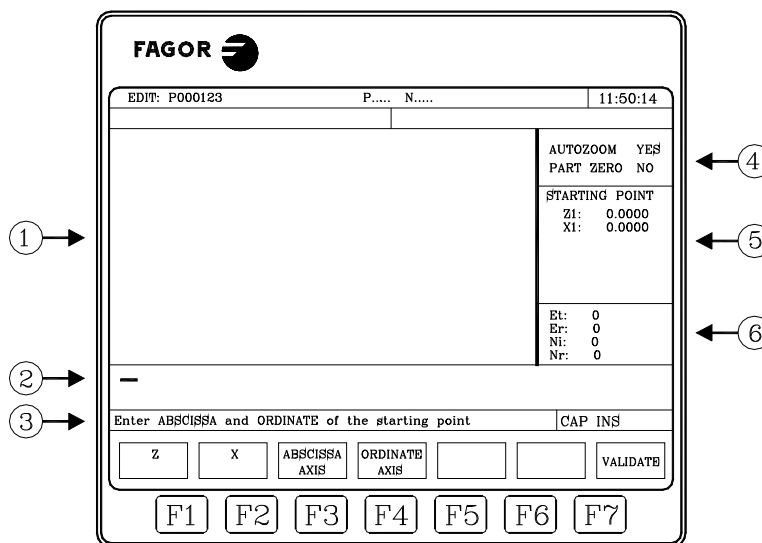

1. Window showing the graphic representation of the profile being edited.
2. Editing window showing the new generated block in CNC language.
3. Area for editing messages.
4. Displayed area. Status of functions autozoom and part zero.
5. Display area for the profile section currently selected for editing or modifying.
6. Window for additional data that shows a series of parameters for internal use and whose meanings are:
 - Et - Total elements of the profile.
 - Er - Complete elements.
 - Ni - Number of data entered
 - Nr - Number of required data

Graphics window

The coordinate axes are displayed with the name of each axis in their positive direction. It also resizes those axes.

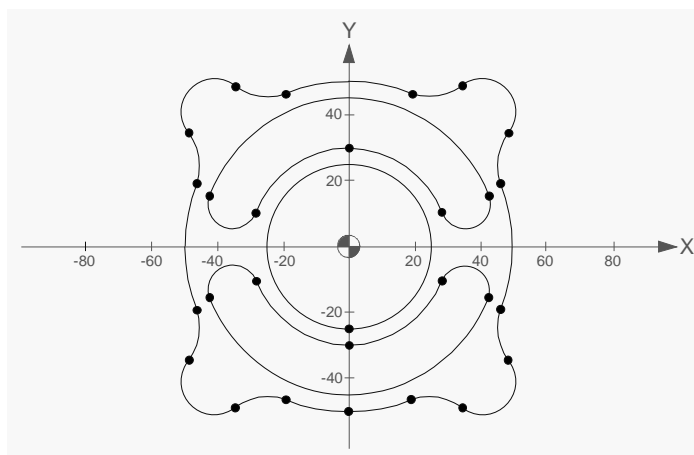

The profile graphics takes into account the value of general machine parameter GRAPHICS (P16) to determine the direction and position of the axes.

If while editing a profile, the user changes the configuration of the direction of any of the axes and presses "VALIDATE", the new configuration will be registered when saving the profile. Once this is done, when restoring the profile, the saved configuration will also be restored.



CNC 8055
CNC 8055i

.T. MODEL
SOFT: V01.3X

If while editing a profile, the axis direction configuration is not changed, no reference to them will be saved and when restoring that profile, the direction of the axes will be taken from g.m.p. GRAPHICS (P16).

Example:

Adapting the coordinate system to g.m.p. GRAPHICS (P16).

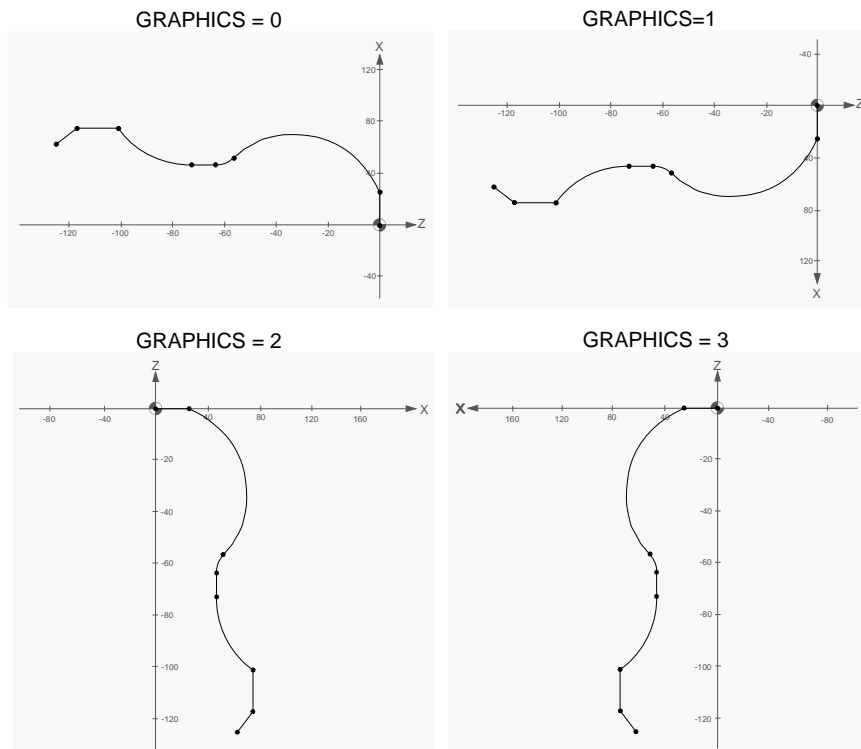

Operation with the profile editor

Several profiles may be edited without quitting the editor. To edit a profile, proceed as follows:

1. Select a point of the profile as its beginning point.
2. Break the profile into straight and curve sections. If it has corner rounding, chamfering or tangential entries or exits, use one of these methods:
 - Treat them as individual sections when having enough information to define them.
 - Ignore them while defining the profile and, once the full definition is done, select the corners that have those characteristics and enter the corresponding radius value.

Editing the profile data

When selecting a new section of the profile, the data needed to define it is shown on the right hand side of the screen. The data may be selected from the softkey menu or directly at the window with the [↑] [↓] keys.

The data may be defined with a number or any expression resulting in a number. For example:

- X 100
- X 10 * COS 45
- X 20 + 30 * SIN 30
- X 2 * (20 + 30 * SIN 30)

Type of coordinates: Cartesian or Polar / absolute or incremental.

The profile data may be edited in either Cartesian or Polar coordinates and either in absolute or incremental coordinates. The type of coordinates is selected from the softkey menu. If a particular element cannot be programmed in some type of coordinates, the CNC will not show the corresponding softkey.



CNC 8055
CNC 8055i

.T. MODEL
SOFT: V01.3x

Programming in Polar coordinates requires editing the Polar origin of each point. The data definition area offers room to edit this data and the graphic window will show the active Polar origin.

Initiate the session at the profile editor.

"EDIT" softkey

This softkey gives access to the profile editor. It may be used to edit a rectangular or circular profile or any profile made up of straight or curved sections.

"CONFIGURATION" softkey

Use the [abscissa axis] and [ordinate axis] softkeys to select the editing plane. Use the [Along the abscissa] and [along the ordinate] softkeys to select the direction of the axes of the plane. To assume the new configuration, press the "VALIDATE" softkey.

"DISPLAY AREA" softkey

When selecting this option, the following softkey options are shown:

[Zoom +]	To enlarge the image on the screen.
[Zoom -]	To reduce the image on the screen.
[Optimum area]	To show the full profile on the screen.
[Autozoom]	The CNC recalculates the graphics display area or not when the edited lines go beyond it.
[Part zero]	Always see the part zero.
[Validate]	It assumes the new configuration.

The display area may be moved around with the [↑][↓][←][→] keys and the zoom may be modified using the [+][−] keys. The display area may be modified while editing the profile with the "MODIFY" softkey.

The editor offers are 5 hotkeys to modify the zoom and the part zero that will be functional when not editing data.

Hotkey	Meaning
+	Zoom +.
-	Zoom -.
*	It changes the Autozoom status.
/	It changes the Part Zero status.
=	It shows the best area.

"FINISH" softkey

This softkey must be pressed once all the sections of the profile have been defined. When pressing this softkey, the CNC quits the profile editor and adds to the program the ISO-code corresponding to the profile just edited. See ["End the session with the profile editor."](#) on page 93.

"SAVE AND CONTINUE" softkey

This softkey saves the profile without having to finish the session with the editor.

Editing a circular profile

A circular profile may be quickly defined using this option. The softkey menu may be used to define the data in either Cartesian or Polar coordinates and either in absolute or incremental coordinates. The type of coordinates at the beginning of the editing operation will be in Cartesian and absolute.

- The starting point and the center of a circular profile may be edited both in Cartesian and in Polar coordinates; but they both must have the same type of coordinates. Changing from Cartesian

5.

EDIT
EditCNC 8055
CNC 8055i-T- MODEL
SOFT: V01.3X

coordinates to Polar coordinates or vice versa affects both points. When programmed in Polar coordinates, the Polar origin will be the same for both points.

- The starting point of the circle can only be edited in absolute coordinates, whereas the center may be edited in absolute as well as in incremental coordinates.

If the starting point is not defined, the CNC assumes one.

The "Profile Direction" softkey indicates whether the profile is programmed clockwise or counterclockwise. This data is very important for later modifications and profile intersection. Every time this softkey is pressed, the text at the top of the middle right window changes.

Editing a rectangular profile

A rectangular profile may be quickly defined using this option. The softkey menu may be used to define the data in either Cartesian or Polar coordinates. The type of coordinates at the beginning of the editing operation will be in Cartesian and absolute.

- The starting point of the rectangle can be edited in Cartesian as well as Polar coordinates, but always in absolute coordinates.

The "Profile Direction" softkey indicates whether the profile is programmed clockwise or counterclockwise. This data is very important for later modifications and profile intersection. Every time this softkey is pressed, the text at the top of the middle right window changes.

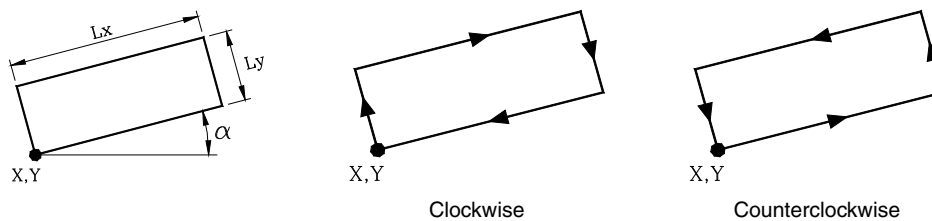

A straight angular profile is defined with a single command, but the CNC internally breaks into 4 straight segments.

Editing any profile

A profile with straight and arc sections may be defined with this option. For any element of the profile, the softkey menu may be used to define the data in either Cartesian or Polar coordinates and either in absolute or incremental coordinates.

When pressing the "PROFILE" softkey, the CNC requests the starting point of the profile. To define it, use the corresponding softkeys. The starting point of a profile can be edited in Cartesian as well as Polar coordinates, but always in absolute coordinates. The type of coordinates at the beginning of the editing operation will be in Cartesian and absolute.

For example, if when working in the ZX plane the new desired starting point is (Z50, X20):

[X] 20 [ENTER]

[Z] 50 [ENTER]

Once the starting point has been set, press the "VALIDATE" softkey. The graphic area will show a filled circle to indicate the profile's starting point.



CNC 8055
CNC 8055i

.T. MODEL
SOFT: V01.3x

Also, the softkeys will show the following options:

[STRAIGHT]	To edit a straight section.
[CLOCKWISE ARC]	To edit a clockwise arc.
[COUNTERCLOCKWISE ARC]	To edit a counterclockwise arc.
[CORNERS]	To insert rounding, chamfers, tangential entries and exits.
[MODIFY]	To modify the edited profile.
[NEW PROFILE]	To edit a new profile.
[FINISH]	It must be pressed when all the sections of the profile have been defined.

5.

EDIT
Edit

Definition of a straight section

The final point of the straight line can be edited in Cartesian as well as Polar coordinates, and in absolute as well as incremental coordinates. The type of coordinates at the beginning of the editing operation will be the same as that of its starting point.

When selecting [STRAIGHT LINE] accessing this mode, the CNC shows the following screen:

- Cartesian coordinates.

X1, Y1	Coordinates of the section's starting point. They cannot be modified because they belong to the endpoint of the previous section.
X2, Y2	Coordinates of the section's endpoint.
α	Angle of the line referred to the abscissa axis.
TANGENCY	Indicates whether the line to be drawn is tangent to the previous section or not.
- Polar coordinates.

r1, φ 1	Radius and Polar angle of the starting point of the segment. They cannot be modified because they belong to the endpoint of the previous section.
r2, φ 2	Radius and Polar angle of the final point of the segment.
α	Angle of the line referred to the abscissa axis.
TANGENCY	Indicates whether the line to be drawn is tangent to the previous section or not.

All parameters need not be defined; but it is recommended to define all the known data. To define a parameter, press the corresponding softkey, key in the desired value and press [ENTER]. The value may be defined by a numeric constant or by any expression.

Once all the known parameters have been defined, press the [VALIDATE] softkey and the CNC will show the section that has been defined. If there is not enough data to show the section, the CNC will show a dotted line indicating its orientation.

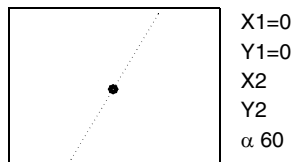

If there are more than one possibility, all the possible options will be shown and the desired one (highlighted in red) must be selected using the [←] and [→] keys.

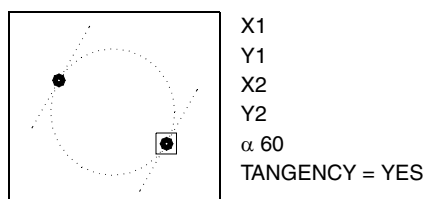

Use the [↑] and [↓] keys to choose whether all the possible options are shown or only the one highlighted in red. Once the desired option is selected, press [ENTER] for the CNC to assume it.

FAGOR

CNC 8055
CNC 8055i-T- MODEL
SOFT: V01.3X

Definition of an arc

The final point and the center of the arc can be edited in Cartesian as well as Polar coordinates, and in absolute as well as incremental coordinates. These two points are independent and each of them may be edited with different types of coordinates. If both points are edited in Polar coordinates, they may have different Polar coordinates.

If the section previous to the one being defined is an arc, the type of coordinates of the starting point must be the same as that of the final point of the previous point and the type of coordinates of the center must be the same as that of the center of the previous section.

If the section previous to the one being defined is a straight section, the type of coordinates of the final point and that of the center must be the same as that of its starting point.

When selecting [CLOCKWISE ARC] or [COUNTERCLOCKWISE ARC] accessing this mode, the CNC shows the following screen:

- Cartesian coordinates.

X1, Y1	Coordinates of the arc's starting point. They cannot be modified because they belong to the endpoint of the previous section.
X2, Y2	Coordinates of the arc's endpoint.
XC, YC	Coordinates of the arc center.
RA	Arc radius
TANGENCY	Indicates whether the arc to be drawn is tangent to the previous section or not.

- Polar coordinates.

X1, Y1	Radius and Polar angle of the arc's starting point. They cannot be modified because they belong to the endpoint of the previous section.
r2, φ2	Radius and Polar angle of the final point of the arc.
rC, φC	Radius and Polar angle of the arc center.
RA	Arc radius
TANGENCY	Indicates whether the arc to be drawn is tangent to the previous section or not.

All parameters need not be defined; but it is recommended to define all the known data. To define a parameter, press the corresponding softkey, key in the desired value and press [ENTER]. The value may be defined by a numeric constant or by any expression.

Once all the known parameters have been defined, press the [VALIDATE] softkey and the CNC will show the section that has been defined. If there are more than one possibility, all the possible options will be shown and the desired one (highlighted in red) must be selected using the [◀] and [▶] keys.

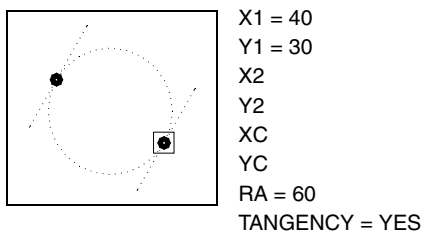

Use the [↑] and [↓] keys to choose whether all the possible options are shown or only the one highlighted in red. Once the desired option is selected, press [ENTER] for the CNC to assume it.

If there isn't enough data to show the section, the CNC will draw as much of it as it knows.



CNC 8055
CNC 8055i

.T. MODEL
SOFT: V01.3x

Corners

When selecting this option, the CNC shows the following option softkeys:

Rounding	For rounding any corners of the profile.
Chamfer	For adding chamfers at any corner of the profile.
Tangential entry	To define a tangential tool entry into the profile when machining.
Tangential exit	To define a tangential tool exit from the profile at the end of the machining operation.

When selecting one of these, one of the corners of the profiles will appear highlighted. To select another corner of the same profile, use the [↑][↓][←][→] keys. To select a corner of another profile, use the [page up] and [page down] keys.

To define the rounding, enter the rounding radius and press [ENTER].

To define the chamfer, enter the chamfer radius and press [ENTER].

To define the tangential entry, enter the radius of the path that the tool has to follow when doing a tangential entry and press [ENTER].

To define the tangential exit, enter the radius of the path that the tool has to follow when doing a tangential exit and press [ENTER].

To quit the CORNER mode, press [ESC].

Modify a profile

When selecting this option, the CNC shows the following option softkeys. To quit the MODIFY mode, press [ESC].

Starting point	To modify the starting point of the profile.
Modify element	To modify any element of the profile, even the type of element (straight line, clockwise or counterclockwise arc).
Insert element	To insert a new element (straight or arc) in any position of the profile.
Delete element	To delete any element of the profile.
Additional text	To add additional text to any section of the profile.
Configuration	To add a new editing plane or redefine the Autozoom option.
Display area	To change the display area.

When selecting one of these options, one of the elements of the profile or profiles will be highlighted. To select another element of the same profile, use the [↑][↓][←][→] keys. To select an element of another profile, use the [page up] and [page down] keys.

"Starting point" softkey

1. Select the starting point of the desired profile. The CNC shows the values used to define it.
2. Modify the desired values and press the [VALIDATE] softkey.

If it is the starting point of a "circular profile" or of a "rectangular profile", it modifies the profile what is necessary so it stays as such.

"Modify element" softkey

1. Select the desired element. The CNC shows the values used to define it.
2. It is possible to change the type of section (straight or arc), redefine the existing data, define a new data or delete an existing one.

A "circular profile" is treated as a single element and a "rectangular profile" may be treated as a whole profile or each element separately.

3. To delete data, press the softkey that defines it and press [ESC].
4. Once the element has been modified, press the "VALIDATE" softkey. The CNC recalculates the new profile.

5.

EDIT
Edit

CNC 8055
CNC 8055i

.T. MODEL
SOFT: V01.3X

"Insert element" softkey

1. Select the point, or corner, after which the new one is to be inserted.
2. Select the type of section (straight or arc), define it and press the "VALIDATE" softkey. The CNC recalculates the new profile.

"Delete element" softkey

1. Select the element to be deleted and confirm the command.
2. Deleting a circular profile deletes the whole profile. When deleting a rectangular profile, it is possible to either delete the whole profile or each element separately.
3. The CNC recalculates the new profile.

"Additional Text" softkey

1. Select the desired element. The CNC shows the ISO code corresponding to that section in the editing area.
2. Add the desired text. Functions F, S, T, D, M or program comments may be added.
3. Press the "VALIDATE" softkey.

"Display area" softkey

When selecting this option, the following softkey options are shown:

[Zoom +]	To enlarge the image on the screen.
[Zoom -]	To reduce the image on the screen.
[Part zero]	Always see the part zero.
[Optimum area]	To show the full profile on the screen.
[Autozoom]	The image is fitted automatically if it is larger than the screen.

The display area may be moved around with the [↑] [↓] [←] [→] keys.

Press the "VALIDATE" softkey. The CNC updates the values indicated in the upper right-hand window (DISPLAYED AREA).

End the session with the profile editor.

This softkey must be pressed once all the sections of the profile have been defined. When pressing this softkey, the CNC quits the profile editor and adds to the program the ISO-code corresponding to the profile just edited. When generating the ISO code of each element, the CNC will show, whenever possible, the type of coordinates used to program it. This way, the program may show blocks in any type of coordinates and G93 blocks (change of Polar origin)

The CNC will try to calculate the requested profile by previously solving all the unknowns. If it finds several possibilities for certain sections, the CNC will show them for each section and the desired option (highlighted in red) will have to be chosen using the [←] [→] keys.

If the profile cannot be resolved due to lack of data, the CNC will issue the relevant message. To quit the profile editor without changing the part-program, press [ESC] and the CNC will request confirmation of this command.

Once the whole profile has been solved, the CNC will show the code of the part program currently being edited. The ISO-coded program for the edited profile is contained between these lines:

```

,***** START *****
,
,***** END *****

```

Do not delete or modify the comment associated with the profile's ISO blocks. It is additional information that the CNC needs to edit the profile again.



CNC 8055
CNC 8055i

.T. MODEL
SOFT: V01.3x

Examples of how to define a profile. Example ·1·

5.
EDIT Edit

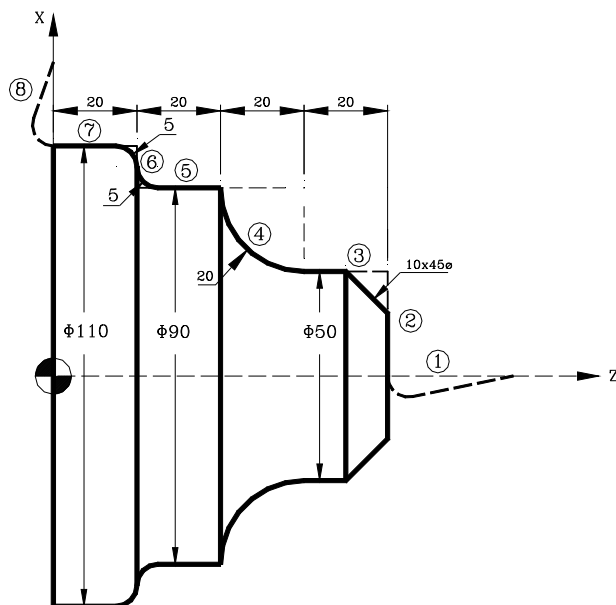

Profile definition without rounding, chamfers or tangential entries and exits.

Abscissa and ordinate of the starting point		X = 100	X = 0
Section 1	STRAIGHT	Z = 80	X = 0
Section 2	STRAIGHT	Z = 80	X = 50
Section 3	STRAIGHT	Z = 60	X = 50
Section 4	CLOCKWISE ARC	Z = 40	X = 90 Zc = 60 Xc = 90 R = 20
Section 5	STRAIGHT	Z = 20	X = 90
Section 6	STRAIGHT	Z = 20	X = 110
Section 7	STRAIGHT	Z = 80	X = 110
Section 8	STRAIGHT	Z = 0	X = 150

Fit image to the screen

Select the DISPLAY AREA option and press the "OPTIMUM AREA" softkey.

Definition of rounding, chamfers and tangential entries and exits

Select the MODIFY option.

TANGENTIAL ENTRY	Select corner 1-2 and press [ENTER].	Radius = 5
CHAMFER.	Select corner 2-3 and press [ENTER].	Radius = 10
ROUNDING	Select corner 5-6 and press [ENTER].	Radius = 5
ROUNDING	Select corner 6-7 and press [ENTER].	Radius = 5
TANGENTIAL EXIT	Select corner 7-8 and press [ENTER].	Radius = 5

Press [ESC] to quit the MODIFY option.

End of editing

Press the "FINISH" softkey. The CNC quits the profile editing mode and the shows the ISO-coded program that has been generated.



CNC 8055
CNC 8055i

·T· MODEL
SOFT: V01.3x

5.2 Modify

This option permits modifying the contents of a selected program block.

Before pressing this softkey, select with the cursor the block to be modified .

Once this option is selected, the softkeys will change their color showing their type of modifying option over a white background.

Also, editing help will be available at any time by just pressing the [HELP] key. To quit this help mode, press [HELP] again.

By pressing the [ESC] key, the information corresponding to that block and which was shown in the editing area will be cleared. From this point on, the block may be edited again.

To quit the block modifying mode, press [CL] or [ESC] to clear the editing window and then press [ESC] again. This way, the selected block will not be modified.

Once the block contents have been modified, press [ENTER]. The new block will replace the previous one.



CNC 8055
CNC 8055i

.T. MODEL
SOFT: V01.3x

5.3 Find

This option is used to find a specific text within the selected program.

When selecting this option, the softkeys will show the following options:

BEGINNING

This softkey positions the cursor over the first program block which is then selected quitting the "find" option.

END

This softkey positions the cursor over the last program block which is then selected quitting the "find" option.

TEXT

With this function it is possible to search for a text or character sequence starting at the current cursor position.

When this softkey is pressed, the CNC requests the character sequence to be found. Once this text has been keyed in, press the "END OF TEXT" softkey and the cursor will position over the first occurrence of the keyed text.

The search will begin from the block the cursor is position on beginning at that block.

The text found will be highlighted being possible to continue with the search or to quit it.

Press [ENTER] to continue the search up to the end of the program. The CNC will begin the search at the last text found and it will highlight it.

The search can be done as many times as desired. Once searched to the end of the program, it will continue the search from the beginning.

Press the "ABORT" softkey or the [ESC] key to quit the search mode. When quitting the search mode, the cursor will be positioned at the last matching text found.

LINE NUMBER

After pressing this softkey, the CNC will request the number of the line to be found. After keying in the desired number and pressing [ENTER], the cursor will position over that block which will then be selected quitting the search mode.

5.

EDIT
Find



CNC 8055
CNC 8055i

-T- MODEL
SOFT: V01.3x

5.4 Replace

With this option it is possible to replace a character sequence with another throughout the selected program.

When selecting this option, the CNC requests the character sequence to be replaced. Once the text to be replaced is indicated, press the "WITH" softkey and the CNC will request the character sequence which will replace the previous one.

Once this text has been keyed in, press the "END OF TEXT" softkey and the cursor will position over the first occurrence of the keyed text.

The search will begin from the block the cursor is position on beginning at that block.

The found text will be highlighted and the following softkey options will appear:

REPLACE

It will replace the highlighted text and will continue the search for the indicated text.

This search will be carried out from the text that was replaced up to the end of the program. If no more occurrences of the text to be replaced are found, the CNC will quit this mode.

The new text found will be highlighted and the softkeys will show the same "replacing" or "not replacing" options.

DO NOT REPLACE

It will NOT replace the highlighted text and will continue the search for the indicated text.

This search will be carried out from the text that was replaced up to the end of the program. If no more occurrences of the text to be replaced are found, the CNC will quit this mode.

The new text found will be highlighted and the softkeys will show the same "replacing" or "not replacing" options.

TO THE END

This option will find and replace the selected text throughout the whole program.

This "find and replace" will start at the highlighted text and will go on to the end of the program.

ABORT

This option will not replace the highlighted text and it will quit the "find and replace" mode.



5.5 Delete block

With this function it is possible to delete a block or group of blocks.

To delete only one block, just position the cursor over it and press [ENTER].

To delete a group of blocks, indicate the first and last blocks to be deleted. To do that, proceed as follows:

1. Position the cursor over the first block to be deleted and press the "INITIAL BLOCK" softkey.
2. Position the cursor over the last block to be deleted and press the "FINAL BLOCK" softkey.
If the last block to be deleted is also the last one of the program, it can also be selected by pressing the "TO THE END" softkey.
3. Once the first and last blocks are selected, the CNC will highlight the selected blocks requesting confirmation to delete them.

5.**EDIT**

Delete block



CNC 8055
CNC 8055i

-T- MODEL
SOFT: V01.3x

5.6 Move block

With this option it is possible to move a block or group of blocks by previously indicating the first and last blocks to be moved. To do that, proceed as follows:

1. Position the cursor over the first block to be moved and press the "INITIAL BLOCK" softkey.
2. Position the cursor over the last block to be moved and press the "FINAL BLOCK" softkey.

If the last block to be moved is also the last one of the program, it can also be selected by pressing the "TO THE END" softkey.

To move only one block, the "initial block" and the "final block" will be the same one.

Once the first and last blocks are selected, the CNC will highlight the selected blocks requesting confirmation to move them.

Then, indicate the block after which this group of blocks must be placed.

Press the "START OPERATION" softkey to carry out this command.



CNC 8055
CNC 8055i

.T. MODEL
SOFT: V01.3x

5.7 Copy block

With this option it is possible to copy a block or group of blocks by previously indicating the first and last blocks to be copied. To do that, proceed as follows:

1. Position the cursor over the first block to be copied and press the "INITIAL BLOCK" softkey.
2. Position the cursor over the last block to be copied and press the "FINAL BLOCK" softkey.

If the last block to be copied is also the last one of the program, it can also be selected by pressing the "TO THE END" softkey.

To copy only one block, the "initial block" and the "final block" will be the same one.

Once the first and last blocks are selected, the CNC will highlight the selected blocks requesting confirmation to copy them.

Then, indicate the block after which this group of blocks must be placed.

Press the "START OPERATION" softkey to carry out this command.

5.**EDIT**
Copy block

CNC 8055
CNC 8055i

-T- MODEL
SOFT: V01.3x

5.8 Copy to program

With this option it is possible to copy a block or group of blocks of one program into another program.

When selecting this option, the CNC will request the number of the destination program where the selected block or blocks are to be copied. After entering the program number press [ENTER].

Next, indicate the first and last blocks to copy. To do that, proceed as follows:

1. Position the cursor over the first block to be copied and press the "INITIAL BLOCK" softkey.
2. Position the cursor over the last block to be copied and press the "FINAL BLOCK" softkey.

If the last block to be copied is also the last one of the program, it can also be selected by pressing the "TO THE END" softkey.

To copy only one block, the "initial block" and the "final block" will be the same one.

Once the first and last blocks are selected, the CNC will highlight the selected blocks and will execute the command.

If the destination program already exists, the following options will be displayed:

- Write over the existing program. All the blocks of the destination program will be erased and will be replaced by the copied blocks.
- Append (add) the copied blocks behind the ones existing at the destination program.
- Abort or cancel the command without copying the blocks.

5.EDIT
Copy to program**FAGOR** **CNC 8055
CNC 8055i**-T- MODEL
SOFT: V01.3x

5.9 Import a program

With this option it is possible to include or merge the contents of a program from any unit, except DNC, into the currently selected program.

Once this option is selected, the CNC will request the number of the source program to be merged. After entering the program number press [ENTER].

Next, indicate with the cursor the block after which the source program will be included.

Press the "START OPERATION" softkey to carry out this command.

5.**EDIT**

Import a program



CNC 8055
CNC 8055i

·T· MODEL
SOFT: V01.3x

5.10 Editor parameters

With this option it is possible to select the editing parameters used in this operating mode.

The options or parameters available are described here and they are selected by softkeys.

5.10.1 Autonumbering

With this option it is possible to have the CNC automatically number (label) the blocks after the one being edited. This function will not number the already existing blocks.

Once this option is selected, the CNC will display the "ON" and "OFF" softkeys to either activate (ON) or deactivate (OFF) this function.

When activating the auto-numbering, the softkeys will show the following options:

STARTING

After pressing this softkey, enter the starting block number to be used on the next block to be edited. The default value for this parameter is "0".

STEP

When pressing this softkey, the CNC will request the numbering step between two consecutive blocks.

After pressing this softkey, Enter the starting block number to be used on the next block to be edited. To do this, select the "STARTING" softkey.

After defining the step and the beginning, if so requested, press [ENTER] for this value to be assumed by the CNC. The default value for this parameter (STEP) is "10".

5.EDIT
Editor parameters**FAGOR** CNC 8055
CNC 8055i-T- MODEL
SOFT: V01.3x

5.10.2 Selection of the axes for TEACH-IN editing

Remember that in the TEACH-IN editing mode, when the block being edited has no information (empty editing area or window), the [ENTER] key may be pressed in which case the CNC will generate a new block with the current position values of the axes.

The option described here, permits the selection of the axes whose position values will be automatically entered in said block.

After pressing the "TEACH-IN AXES" softkey, the CNC shows all the axes of the machine.

The operator must eliminate, pressing the corresponding softkeys, the axis or axes not desired. Every time a softkey is pressed, the CNC will eliminate the corresponding axis displaying only the selected ones.

To end this operation, press [ENTER].

The CNC will assume from now on and whenever editing in TEACH-IN, the selected axes. To change those values, access this option again and select the new axes.

5.**EDIT**

Editor parameters



CNC 8055
CNC 8055i

-T- MODEL
SOFT: V01.3x

This mode of operation will be used whenever the manual control of the machine is desired.

Once this mode of operation is selected, the CNC allows the movement of all the axes by means of the jog keys located on the operator panel, or by means of the electronic handwheel (if available). Likewise, the CNC will enable the keys of the operator panel to control the movement of the machine's spindle.

With the MDI option it is possible to modify the machining conditions (type of moves, feedrates, etc.) being selected. Also, the CNC will maintain the ones selected in this mode when switching to "EXECUTION" or "SIMULATION" modes.

This operating mode offers the following softkey options:

"Home search" softkey

With this option it is possible to perform a home search on the desired axis or axes. Once this option is selected, the CNC will show a softkey for each axis and the "ALL" softkey.

The CNC offers two ways to search the machine reference (home):

- By selecting the "ALL" softkey and using the subroutine associated with function G74. The number of this subroutine will be defined by the general machine parameter "REFSUB".
- By selecting the axis or axes to be referenced.



If the "ALL" softkey is selected, the CNC will highlight (in reverse video) the names of all axes and after pressing the [START] key, it will execute the subroutine associated with G74.

To search home on one to all axes at once (without executing the associated subroutine), press the softkeys corresponding to those axes. After pressing each softkey, the CNC will highlight the name of the selected axis. If an unwanted axis has been selected, press [ESC] to cancel that selection and return to select "REFERENCE SEARCH".

Once all the desired axes have been selected, press [START]. The CNC will start the home search by moving all selected axes at once until the home reference switches for all axes are pressed. The CNC will then do the home search one axis at a time.

The home search and the part zero.

When searching home using the "ALL" softkey, the CNC will maintain the part zero or zero offset active at the time. However, if the axes have been selected one by one, the CNC will assume the "home" position as the new part zero.

6.

JOG

When must a home search be done

The CNC demands a home search in the following cases.

- On CNC power-up.
- After executing the sequence [SHIFT] [RESET].
- When the feedback is direct through the axes board and a feedback alarm occurs.
- When losing feedback count via Sercos due to broken communication. Difference greater than 10 microns (0.00039 inches) or 0.01^o
- When modifying certain machine parameters; for example, number of axes.

"PRESET" softkey

With this function it is possible to preset the desired axis position value. Once this option is selected, the CNC will show the softkey corresponding to each axis.

After pressing the softkey of the corresponding axis to be preset, the CNC will request the position value to be preset with.

Press [ENTER] after the value has been keyed in so the new value is assumed by the CNC.

"TOOL CALIBRATION" softkey

With this function it is possible to calibrate the length of the selected tool by using a part of known dimensions for this purpose.

Before pressing this softkey, the tool to be calibrated must be selected.

Tool calibration without a probe

The tool calibration is performed axis by axis (X, Z). Follow these steps:

1. Press the softkey corresponding to the axis [X] or [Z].
2. The CNC will request the position value of the known part at the touch point. Once this value has been keyed in, press [ENTER] for this value to be assumed by the CNC.
3. Move the tool using the JOG keys until touching the part.
4. Press the "LOAD" softkey for that axis.

The CNC will perform the necessary calculations and it will assign the new value to the selected tool length offset.

Repeat these operation to calibrate the tool along the other axis.

Probing

When using a probe for tool calibration, the following machine parameters must be properly set: "PRBXMIN", "PRBXMAX", "PRBYMIN", "PRBYMAX", "PRBZMIN", "PRBZMAX" and "PRBMOVE".

The tool calibration is performed axis by axis (X, Z) in either one of these modes: "without a probe" as described above and as follows:

1. Position the tool facing the probe.
2. Position the tool in front of the probe. Press the softkey that indicates the direction of the tool calibration. [PROBE X+], [PROBE X-], [PROBE Z+], [PROBE Z-].
3. The CNC will move the tool at the feedrate indicated by the machine parameter for that axis "PRBFEEED" until touching the probe. The maximum distance the tool can move is set by machine parameter "PRBMOVE".
4. When the tool touches the probe, the CNC stops the axis and, after making the pertinent calculations, it will assign the new tool length value to its corresponding offset.



CNC 8055
CNC 8055i

.T. MODEL
SOFT: V01.3x

Repeat these operation to calibrate the tool along the other axis.

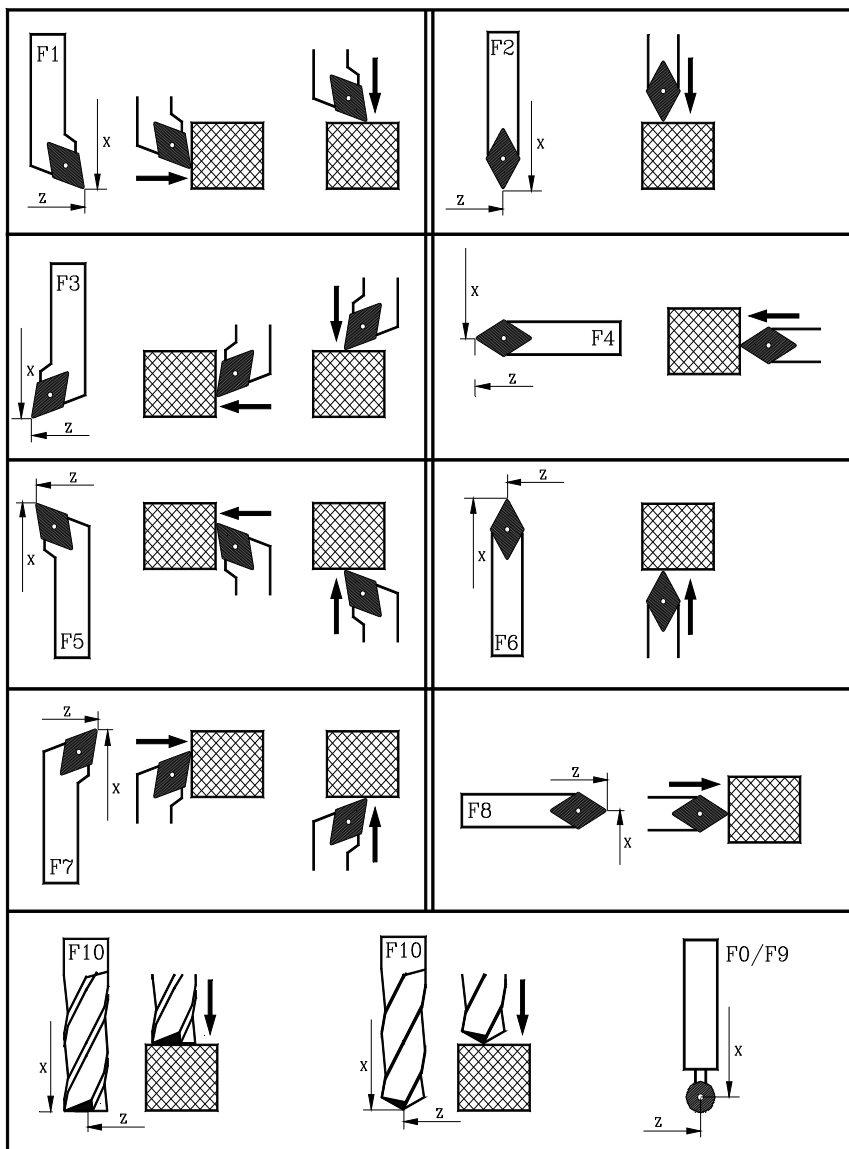

6.
JOB

"MDI" softkey

With this function it is possible to edit and execute a block (ISO or high-level) providing the necessary information by means of softkeys.

Once a block has been edited and after pressing the [START] key, the CNC will execute this block without leaving this operating mode.



When searching home "G74", the CNC will maintain the part zero or zero offset active at the time.

History of executed blocks.

From the MDI mode, pressing the [▲] or [▼] key will open a window that shows the last 10 instructions that have been executed. This window resizes itself to fit the number of instructions that have been saved. To execute or modify an MDI line that has been executed earlier, proceed as follows:



CNC 8055
CNC 8055i

.T. MODEL
SOFT: V01.3x

1. Open the window that shows the last MDI instructions:
 - If the cursor is at the beginning of the line, press [↑]. Pressing [↓] moves the cursor to the end of the line.
 - If the cursor is at the end of the line, press [↓]. Pressing [↑] moves the cursor to the beginning of the line.
 - If the cursor is neither at the beginning nor at the end of the line, both keys [↑] and [↓] open the window that shows the last MDI instructions.
2. Use the [↑] or [↓] key to select the desired instruction.
 - Press [START] to execute the selected instruction.
 - Press [ENTER] to modify the selected instruction. Once the instruction has been modified, press [START] to execute it.

An MDI instruction is saved only if it is correct and if it is not the same as the previous one on the list. The instructions are kept saved even after turning the unit off.

"USER" softkey

When selecting this option, the CNC will execute, in the user channel, the program whose number is indicated in the general machine parameter "USERMAN".

To quit its execution and return to the previous menu, press [ESC].

"DISPLAY" softkey

The available display modes are:

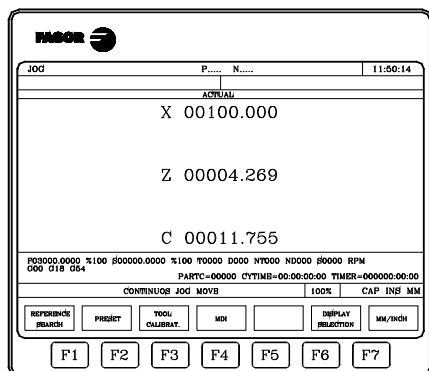

Actual

Shows the current real position of the axes referred to part zero.

When the C axis is active, the position of the X-C axes correspond to the transformed coordinates.

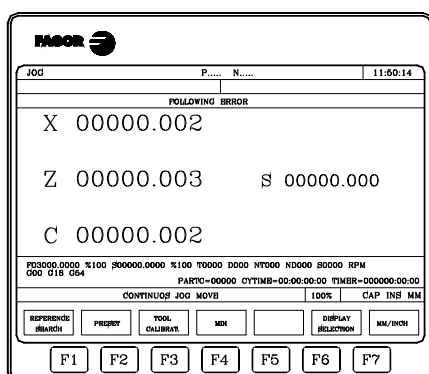

Following error

Difference between the real and the theoretical position of each axis and the spindle.



CNC 8055
CNC 8055i

-T- MODEL
SOFT: V01.3x

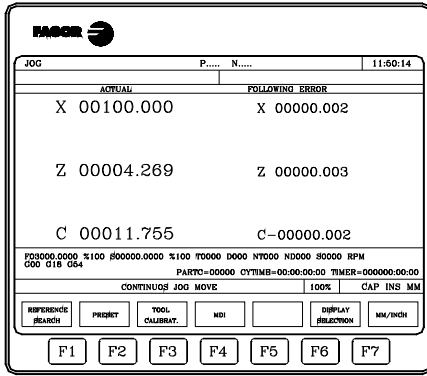

Actual and following error

It shows the real position of the axes and their following error.

When the C axis is active, the position of the X-C axes correspond to the transformed coordinates.

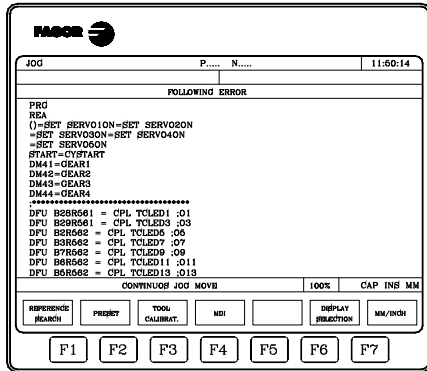

PLC

Access the PLC monitoring mode.

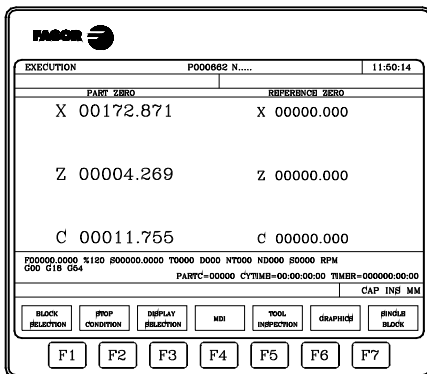

Position

It shows the real position of the axes referred to part zero and to machine zero (home)

When the C axis is active, the position of the X-C axes referred to part zero correspond to the transformed coordinates.

"MM/INCHES" softkey

This softkey toggles the display units for the linear axes from millimeters to inches and vice versa.

The lower right-hand window will indicate which units are selected (MM/INCH).

Note that this switching obviously does not affect the rotary axes which are shown in degrees.



CNC 8055
CNC 8055i

.T- MODEL
SOFT: V01.3x

6.1 Jog

6.1.1 Continuous Jog

Once the % override of the jogging feedrate (indicated by axis-machine parameter "JOGFEED") has been selected with the switch at the Operator Panel , press the jog keys corresponding to the desired axis and to the desired jogging direction.

The axes can be jogged one at a time and in different ways depending on the status of the general logic input "LATCHM":

- If the PLC sets this mark low, the axes will be jogged while pressing the corresponding Jog key.



- If the PLC sets this mark high, the axes will move from the moment the corresponding JOG key is pressed until the [STOP] key or other JOG key is pressed. In this case, the movement will be transferred to that indicated by the new key.



If while jogging an axis, the rapid key is pressed, the axis will move at the feedrate established by machine parameter "G00FEED" for this axis as long as this key stays pressed. This feedrate will be applied while this key is pressed and it will restore the jogging feedrate percentage (0% to 120%) indicated in axis machine parameter "JOGFEED" when this key is released.



CNC 8055
CNC 8055i

-T- MODEL
SOFT: V01.3X

6.1.2 Incremental jog

It allows to jog the selected axis in the selected direction an incremental step selected by the Feedrate Override switch of the operator panel. This movement will be carried out at the jog feedrate indicated by axis machine parameter "JOGFEED".

The available positions are 1, 10, 100, 1000 and 10000 that indicate the units to move the axis. These units correspond to the units used for display.

Example: Display format: 5.3 in mm or 4.4 in inches.

Switch position	Distance
1	0.001 mm or 0.0001 inches
10	0.010 mm or 0.0010 inches
100	0.100 mm or 0.0100 inches
1000	1.000 mm or 0.1000 inches
10000	10.000 mm or 1.0000 inches

The maximum permitted step is 10 mm or 1 inch regardless of the selected display format (for example: 5.2 in mm or 4.3 in inches) the movement for the 1000 and 10000 positions will be the maximum allowed.

After selecting the desired incremental move at the switch, if a jog key is pressed, the corresponding axis will move the selected distance in the selected direction.



If while jogging an axis, the rapid key is pressed, the axis will move at the feedrate established by machine parameter "G00FEED" for this axis as long as this key stays pressed. This feedrate will be applied while this key is pressed and it will restore the jogging feedrate percentage (0% to 120%) indicated in axis machine parameter "JOGFEED" when this key is released.



CNC 8055
CNC 8055i

.T. MODEL
SOFT: V01.3x

6.1.3 Path-jog mode.

The "path jog" mode acts when the switch is in one of the continuous or incremental jog positions. This feature may be used to act upon the jog keys of an axis to move both axes of the plane at the same time for chamfering (straight sections) and rounding (curved sections). The CNC assumes as "Path jog" the keys associated with the X axis.

The data to define the paths is defined using the following variables.

- For a linear path, indicate the path angle in the MASLAN variable (value in degrees between the linear path and the first axis of the plane).
- For an arc, indicate the arc center coordinates in the MASCFI, MASCSE variables (for the first and second axes of the main plane).

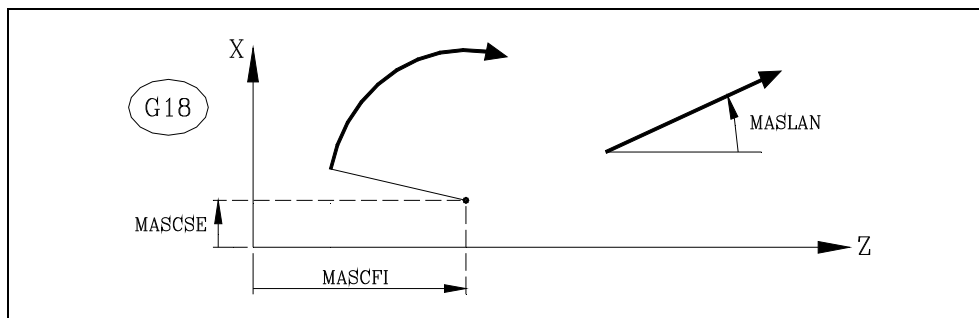

Variables MASLAN, MASCFI and MASCSE may be read and written from the CNC, DNC and PLC.



This feature must be managed from the PLC. This feature is usually activated and deactivated by means of an external push-button or a key configured for that purpose, as well as the selection of the type of path.

Operation in path-jog mode

The "path jog" mode is only available with the X axis keys. When pressing one of the keys associated with the X axis, the CNC behaves as follows:

Switch position	Path-jog	Type of movement
Continuous jog	OFF	Only the axis and in the indicated direction
	ON	Both axes in the indicated direction and along the indicated path
Incremental jog	OFF	Only the axis, the selected distance and in the indicated direction
	ON	Both axes, the selected distance and in the indicated direction, but along the indicated path
Handwheel		It ignores the keys.

The rest of the jog keys always work in the same way, whether "path jog" is on or off. The rest of the keys move only the axis and in the indicated direction.

The movements in path-jog may be aborted by pressing the [STOP] key or setting the jog switch to one of the handwheel positions.

Considerations about the jog movements

This mode assumes as axis feedrate the one selected in jog mode and it will also be affected by the feedrate override switch. If F0 is selected, it assumes the one indicated by machine parameter "JOGFEED (P43)". This mode ignores the rapid jog key.

Path-jog movements respect the travel limits and the work zones.



CNC 8055
CNC 8055i

-T- MODEL
SOFT: V01.3x

6.2 Movement with an electronic handwheel

Depending on their configuration, the various types of handwheels are:

- General handwheel.
This handwheel may be used to jog any axis one by one.
Select the axis and turn the handwheel to move it.
- Individual handwheel.
This handwheel is the replacement for mechanical handwheels. It only moves the axis it is associated with.
Up to 3 handwheels can be used (one per axis).
- Path-handwheel.
This type of handwheel may be used to make chamfers and rounding. Two axes are moved along a selected path (chamfer or rounding) by moving a single handwheel.
The CNC assumes as the path handwheel the general handwheel or, when this one is missing, the one associated with the X axis.
This feature must be managed from the PLC.
- Feed handwheel mode.
This type of handwheel may be used to control the feedrate of the machine.
This feature must be managed from the PLC.
- "Additive handwheel" mode
This type of handwheel may be used to jog the axes while a program is being executed.
This feature must be managed from the PLC.

Movement with handwheel

To move any of them, turn the switch to any of the handwheel positions. Positions 1, 10 and 100 indicate the multiplying factor being applied besides the internal x4 to the feedback pulses supplied by the electronic handwheel.

For example, if the manufacturer has set a distance of 0.100 mm or 0.0100 inches per handwheel turn, thus:

Switch position	Distance per turn
1	0.100 mm or 0.0100 inches
10	1.000 mm or 0.1000 inches
100	10.000 mm or 1.0000 inches



When jogging with handwheels, it may happen that depending on the turning speed and the selector switch position, the CNC be demanded a faster feedrate than the maximum allowed. The CNC will move the axis the indicated distance but at the maximum feedrate allowed.

6.

JOG
Movement with an electronic handwheel



CNC 8055
CNC 8055i

.T. MODEL
SOFT: V01.3x

6.2.1 General or individual handwheel mode

The machine may have a general handwheel and up to 3 individual handwheels associated with each axis. In this case, the individual handwheels have priority over the general handwheel. So, if an individual handwheel is moving, the general handwheel will be ignored.

General handwheel

To jog the axes with the general handwheel:

1. Select the axis to be jogged.

Press one of the JOG keys of the axis to be jogged. The selected axis will be highlighted.

When using a FAGOR handwheel with an axis selector button, the axis may be selected by pressing the push-button on the back of the handwheel. The CNC select the first axis and it highlights it. When pressing the button again, the CNC selects the next axis and so on in a rotary fashion. To deselect the axis, hold the button pressed for more than 2 seconds.

2. Jog the axis.

Once the axis has been selected, it will move as the handwheel is being turned and in the direction indicated by it.

Individual handwheels

Each axis will move as the corresponding handwheel is being turned according to the switch position and in the direction indicated by it.

6.**JOG**

Movement with an electronic handwheel



CNC 8055
CNC 8055i

-T- MODEL
SOFT: V01.3x

6.2.2 Path handwheel

The "path handwheel" mode acts when the switch is in one of the handwheel positions. With this feature, it is possible to jog two axes of the plane at the same time along a linear path (chamfer) or circular path (rounding) with a single handwheel. The CNC assumes as the path handwheel the general handwheel or, when this one is missing, the one associated with the X axis.

The data to define the paths is defined using the following variables.

- For a linear path, indicate the path angle in the MASLAN variable (value in degrees between the linear path and the first axis of the plane).
- For an arc, indicate the arc center coordinates in the MASCFI, MASCSE variables (for the first and second axes of the main plane).

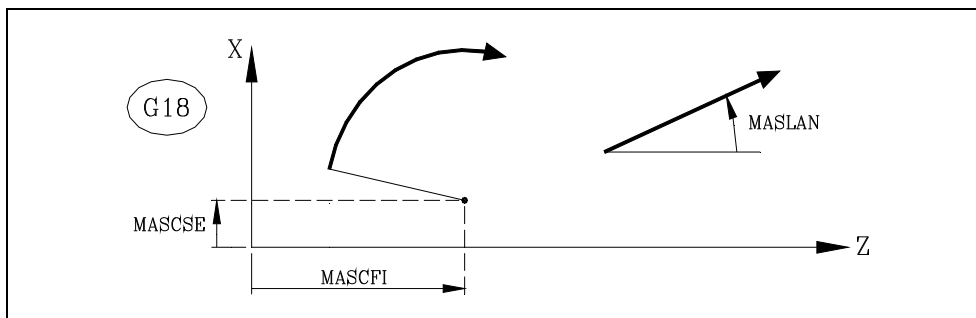

Variables MASLAN, MASCFI and MASCSE may be read and written from the CNC, DNC and PLC.



This feature must be managed from the PLC. This feature is usually activated and deactivated by means of an external push-button or a key configured for that purpose, as well as the selection of the type of path.

Operation in path-handwheel mode

When selecting the path handwheel mode, the CNC behaves as follows.

- If there is a general handwheel, it will be the one working in path handwheel mode. The individual handwheels, if any, will remain associated with the corresponding axes.
- If there is no general handwheel, the individual handwheel associated with the X axis then works in path-handwheel mode.

The movements in path-handwheel may be aborted by pressing the [STOP] key or setting the jog switch to one of the continuous or incremental positions.

Considerations about the jog movements

Path-handwheel movements respect the travel limits and the work zones.

6.2.3 Feed handwheel mode

Usually, when making a part for the first time, the machine feedrate is controlled by means of the feedrate override switch.

From this version on, it is also possible to use the machine handwheels to control that feedrate. This way, the machining feedrate will depend on how fast the handwheel is turned.



This feature must be managed from the PLC. This feature is usually activated and deactivated by means of an external push-button or a key configured for that purpose.

The following CNC variables return the number of pulses the handwheel has turned.

HANPF	Provides the number of pulses of the 1st handwheel.
HANPS	Provides the number of pulses of the 2nd handwheel.
HANPT	Provides the number of pulses of the 3rd handwheel.
HANPFO	Provides the number of pulses of the 4th handwheel.

6.

JOG

Movement with an electronic handwheel



CNC 8055
CNC 8055i

-T- MODEL
SOFT: V01.3x

6.2.4 "Additive handwheel" mode

With manual intervention or additive handwheel, it is possible to move the axes manually while a program is being executed. Once this option is activated, use the handwheel to make a movement to be added to the one resulting from the automatic execution. This movement will be applied as if it were another zero offset.

The general handwheel will be used as the additive handwheel. If there is no general handwheel, use the individual handwheel associated with the axis. Only one additive handwheel may be enabled at a time; the CNC will only attend to the first enabled handwheel.

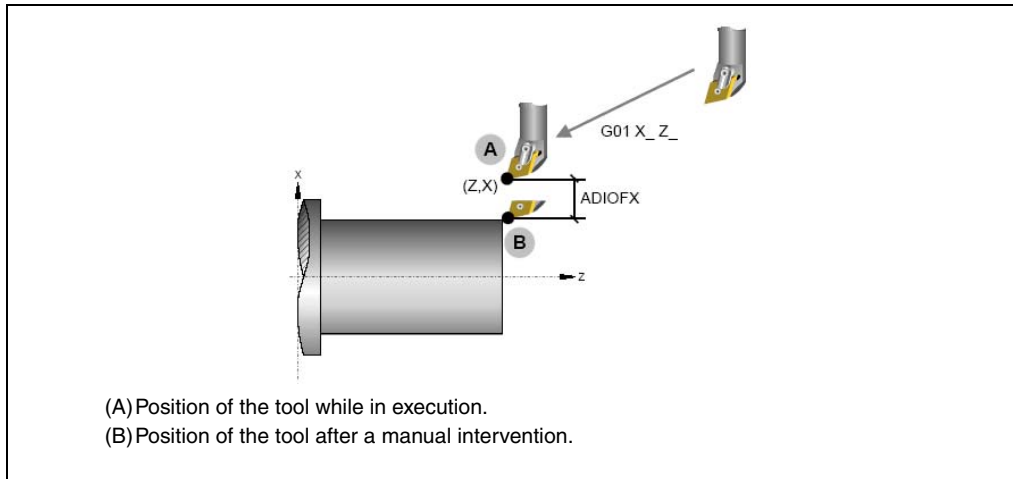

This feature must be managed from the PLC. This feature is usually activated and deactivated by means of an external push-button or a key configured for that purpose.

The intervention with an additive handwheel is only possible in execution mode, even while the program is interrupted. However, it is not allowed in the tool inspection mode.

If the additive handwheel is enabled for a coordinate transformation G46 (incline axis), the handwheel movements are applied to the machining operation even if they are not shown on the graphics screen.

The offset caused by the additive handwheel stays active after disabling the handwheel and it is reset to zero after a home search. The offset stays active or is reset after an M02 or M30 and after an emergency or a reset depending on the setting of axis machine parameter ADIMPG.

Considerations to the additive handwheel.

The movement with the additive handwheel on the master axis is also applied to the slave axis when using axes that are gantry, slaved or synchronized by PLC.

When testing the software limits during block preparation, it checks the theoretical coordinate ignoring the additional movement of the additive handwheel.

The mirror image by PLC is not applied to the additive handwheel movement.

6.

JOG
Movement with an electronic handwheel

FAGOR 

CNC 8055
CNC 8055i

.T. MODEL
SOFT: V01.3x

Configuring the additive handwheel

Handwheel resolution and maximum feedrate.

The resolution of the additive handwheel depends on the setting of parameter ADIMPG. There are two options to set the resolution:

- The resolution of the handwheel is set by parameter ADIMPRES (P177) of the axis.
- The handwheel resolution is set with the switch of the operator panel. If the switch is not in the handwheel position, it assumes a x1 factor.

Maximum feedrate allowed, due to the additive handwheel, is limited by parameter ADIFEED (P84).

Coordinates display

Parameter DIPLCOF determines whether the CNC takes into consideration or not the additive zero offset when displaying the coordinates of the axes on the screen and when accessing the POS(X-C) and TPOS(X-C) variables.

6.**JOG**

Movement with an electronic handwheel







CNC 8055
CNC 8055i

.T. MODEL
SOFT: V01.3x

6.3 Spindle movement

It is possible to control the spindle by means of the following operator-panel keys without the need to execute M03, M04 or M05.

-  Similar to executing function M03. To start the spindle clockwise and displays function M03 in the machining history.
-  Similar to executing function M04. To start the spindle counterclockwise and displays function M04 in the machining history.
-  Similar to executing function M05. To stop the spindle.
-   vary the programmed spindle speed between the % set in spindle machine parameters "MINSOVR" and "MAXSOVR" with incremental steps set in spindle machine parameter "SOVRSTEP".

It is recommended to define the spindle speed before selecting the turning direction in order to avoid an abrupt start because the turning direction had been selected before.

6.

JOG
Spindle movement

FAGOR 

CNC 8055
CNC 8055i

.T. MODEL
SOFT: V01.3x

6.

JOG

Spindle movement



CNC 8055
CNC 8055i

.T. MODEL
SOFT: V01.3x

In order to select a new tool, tool offset or zero offset, it is necessary that those values be previously stored at the CNC.

The following tables may be used for that:

- Zero offset table.
It must be defined. It indicates each axis offset for each zero offset.
- Tool offset table.
It must be defined. It stores the dimensions of each tool.
- Tool table.
It must be defined. It indicates for each tool, the family it belongs to, the offset associated to it, its nominal and real life spans, etc.
- Tool magazine table
It must be defined. It indicates the position each tool occupies in the tool magazine.
- Tool geometry table.
It must be defined. It indicates the dimensions and cutting angle of each cutter.
- Global and local parameters table.
It does not need to be defined.

It is updated by the CNC. When selecting a tool (T) or a tool offset (D), the CNC acts as follows:

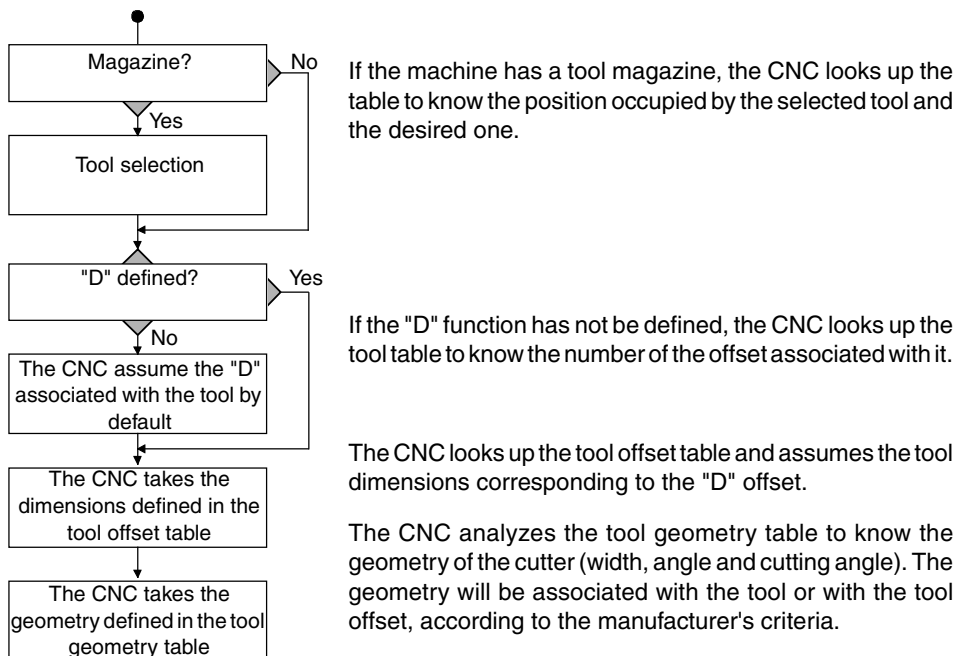

We recommend to save the tables into the hard disk (KeyCF), a peripheral device or a PC.

When accessing the TABLES operating mode, the CNC will show the tables that are saved in the hard disk (KeyCF).



CNC 8055
CNC 8055i

.T- MODEL
SOFT: V01.3x

If on CNC power-up, it detects that any table has been damaged, it checks whether that table has been saved in the hard disk (KeyCF) or not.

- If it is in the hard disk (KeyCF), it asks whether a to make a copy or not.
- If it is not in the hard disk (KeyCF), it asks whether a to initialize with the default values or not.



When copying one of the following tables from the hard disk (KeyCF), it resets the CNC automatically. Zero offsets, M functions, tools, tool magazine, tool offsets, geometry, leadscrew error compensation, cross compensation.

7.

TABLES



CNC 8055
CNC 8055i

.T. MODEL
SOFT: V01.3x

7.1 Zero offset table

This table stores the offset of each axis.

ZERO OFFSET TABLE		P.....	N.....	11:50:14		
ZERO OFFSET						
PLC	X	0.0000	Z	0.0000	C	0.0000
G54=G159N1	X	0.0000	Z	0.0000	C	0.0000
G55=G159N2	X	0.0000	Z	0.0000	C	0.0000
G56=G159N3	X	0.0000	Z	0.0000	C	0.0000
G57=G159N4	X	0.0000	Z	0.0000	C	0.0000
ΔG58(G159N5)	X	0.0000	Z	0.0000	C	0.0000
ΔG58(G159N5)	X	0.0000	Z	0.0000	C	0.0000

CAP INS MM

EDIT MODIFY FIND DELETE LOAD SAVE MM/INCH

F1 F2 F3 F4 F5 F6 F7

The end of the chapter describes how to edit the table. The possible zero offsets are:

PLC. Additive zero offset defined by PLC.

It is used, for example, to correct deviations originated by machine dilatations.

These values are set from the PLC and from the part-program, by means of high level variables "PLCOF(X-C)".

The CNC always adds these values to the zero offset currently active.

G54 through G57. Absolute zero offsets.

They can also be modified from the PLC and from the part-program, by means of high level variables "ORG(X-C)".

In order for one of these absolute zero offsets to be active, it must be selected at the CNC using its corresponding G code (G54, G55, G56 or G57).

G159 N1 to N20. Absolute zero offsets.

To apply any zero offset defined in the table.

The first six zero offsets are the same as programming G54 through G59, except that the values of G58 and G59 are absolute. This is because function G159 cancels functions G54 through G57 and, consequently, there is no active zero offset to add the G58 or G59 to.

G58 and G59. Incremental zero offsets.

They can also be modified from the PLC and from the part-program, by means of high level variables "ORG(X-C)".

In order for one of these incremental zero offsets to be active, it must be selected at the CNC using its corresponding G code (G58 or G59).

The new incremental zero offset will be added to the absolute zero currently selected.

7.

TABLES
Zero offset table

FAGOR 

CNC 8055
CNC 8055i

.T. MODEL
SOFT: V01.3x

7.2 Tool magazine table

This table contains information about the tool magazine indicating all the tools of the magazine and their position in it.

7.
TABLES
 Tool magazine table

MAGAZINE TABLE		P.....	N.....	11:50:14
MAGAZINE POSITION	TOOL	STATUS		
ACTIVE TOOL	T			
NEXT TOOL	T			
P001	T0001	N	A	
P002	T0002	N	A	
P003	T			
P004	T			
P005	T			
P006	T			
P007	T			
P008	T			
P009	T			
P010	T			
P011	T			
P012	T			
P013	T			
P014	T			
P015	T			
P016	T			
P017	T			
P018	T			

Control Panel: CAP INS MM, EDIT, MODIFY, FIND, DELETE, LOAD, SAVE, F1, F2, F3, F4, F5, F6, F7

The end of the chapter describes how to edit the table.

Magazine position

Besides indicating each position in the magazine, it indicates the active tool and the one selected for the following operations.

The next tool will be placed in the spindle after executing auxiliary function M06.

Tool

It indicates the number of the tool occupying that position.

The empty positions appear with the letter "T" and the canceled ones with the characters T****.

Status

The first letter indicates the tool size and the second one its status.

The size depends on the number of pockets it occupies in the magazine.

N = Normal (family 0-199).

S = Special (family 200-255).

The tool status is defined as follows:

A = Available

E = Expired ("real life" greater than "nominal life").

R = Rejected by the PLC.



CNC 8055
 CNC 8055i

.T. MODEL
 SOFT: V01.3x

7.3 Tool table

This table stores information about the tools available indicating the type of tool offset associated with them, their family, etc.

TOOL TABLE		P.....	N.....	11:50:14		
TOOL	OFFSET	FAMILY	NOMINAL LIFE	REAL LIFE	STATUS	
T0001	D001	F001	N00000	R 0000.00	N	A
T0002	D002	F002	N00000	R 0000.00	N	A
T0003	D003	F003	N00000	R 0000.00	N	A
T????	D000	F000	N00000	R 0000.00	N	A
T????	D000	F000	N00000	R 0000.00	N	A
T????	D000	F000	N00000	R 0000.00	N	A
T????	D000	F000	N00000	R 0000.00	N	A
T????	D000	F000	N00000	R 0000.00	N	A
T????	D000	F000	N00000	R 0000.00	N	A
T????	D000	F000	N00000	R 0000.00	N	A
T????	D000	F000	N00000	R 0000.00	N	A
T????	D000	F000	N00000	R 0000.00	N	A
T????	D000	F000	N00000	R 0000.00	N	A
T????	D000	F000	N00000	R 0000.00	N	A
T????	D000	F000	N00000	R 0000.00	N	A
T????	D000	F000	N00000	R 0000.00	N	A
T????	D000	F000	N00000	R 0000.00	N	A
T????	D000	F000	N00000	R 0000.00	N	A
T????	D000	F000	N00000	R 0000.00	N	A
T????	D000	F000	N00000	R 0000.00	N	A
T????	D000	F000	N00000	R 0000.00	N	A
T????	D000	F000	N00000	R 0000.00	N	A
T????	D000	F000	N00000	R 0000.00	N	A
T????	D000	F000	N00000	R 0000.00	N	A
T????	D000	F000	N00000	R 0000.00	N	A
T????	D000	F000	N00000	R 0000.00	N	A
T????	D000	F000	N00000	R 0000.00	N	A
T????	D000	F000	N00000	R 0000.00	N	A
T????	D000	F000	N00000	R 0000.00	N	A

CAP INS MM

EDIT MODIFY FIND DELETE LOAD SAVE MM/INCH

F1 F2 F3 F4 F5 F6 F7

7.

TABLES
Tool table

The end of the chapter describes how to edit the table. Each tool has the following data fields:

Offset number associated with the tool.

Every time a tool is selected, the CNC will assume its dimensions as they appear in the tool offset table for the specified tool offset.

Family code.

It will be used when having an automatic tool changer and it will allow replacing the worn out tool with another one with similar characteristics.

There are two types of families:

- Those for normal tools whose codes are between 0 and 199.
- Those for special tools (which occupy more than one magazine pocket), whose numbers are between 200 and 255.

Every time a new tool is selected, the CNC checks whether it is worn out ("real life" greater than "nominal life"). If that is the case, it will not select it, but it will select another one of the same family, instead.

If while machining a part, the PLC "asks" the CNC to reject the current tool (by activating the logic input "TREJECT"), the CNC will display the message "rejected" in the "STATUS" field and it will replace it with the next tool of the same family that appear in the tool table. This change will take place the next time that tool is selected.

Nominal tool life.

It indicates the machining time (in minutes) or the number of operations that that tool is calculated to last.

Real tool life.

It indicates the machining time (in minutes) or the number of operations already carried out by that tool.

Tool status.

It indicates the size of the tool and its status:



The tool size depends on the number of pockets it takes in the magazine and it is defined as follows:

N = Normal (family 0-199).

S = Special (family 200-255).

The tool status is defined as follows:

A = Available

E = Expired ("real life" greater than "nominal life").

R = Rejected by the PLC.

GEOMETRY

This softkey is available when the machine manufacturer has associated the tool geometry with the tool. When selecting this option, the CNC lets access the tool geometry table.

7.

TABLES
Tool table



CNC 8055
CNC 8055i

.T. MODEL
SOFT: V01.3x

Tool type. Location codes (shape) F0 through F10.

They indicate the tool shape and how it has been calibrated.

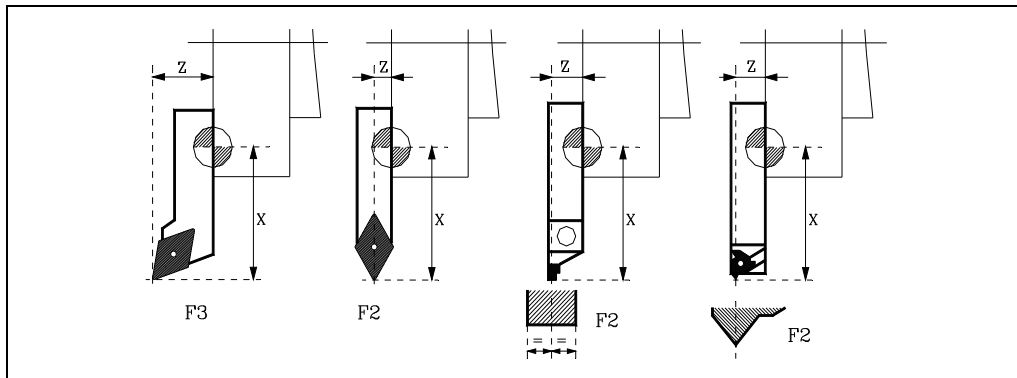

Codes F0 and F9 must only be used when calibrating the tool tip center and not the sides of the cutter.

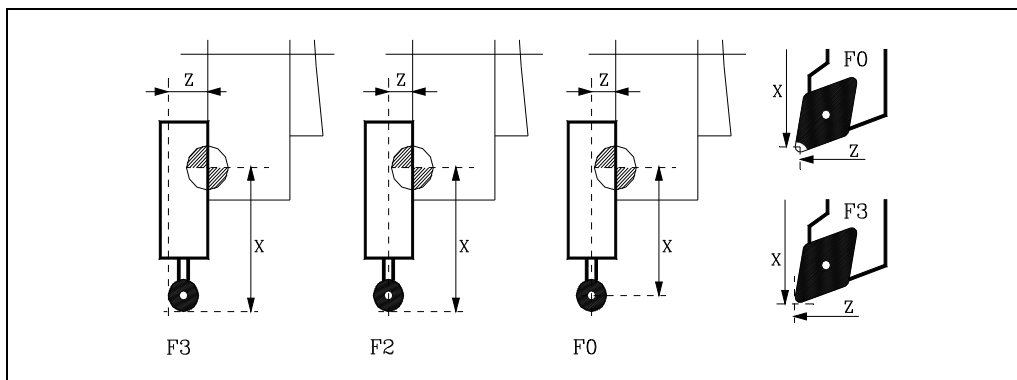

When using an end-mill or a drill bit, this location code must be F10.

7.
TABLES
 Tool Offset table



CNC 8055
 CNC 8055i

.T. MODEL
 SOFT: V01.3x

CODIGOS DE FORMA

LOCATION CODES

CODIGOS F0 y F9

CODES F0 and F9

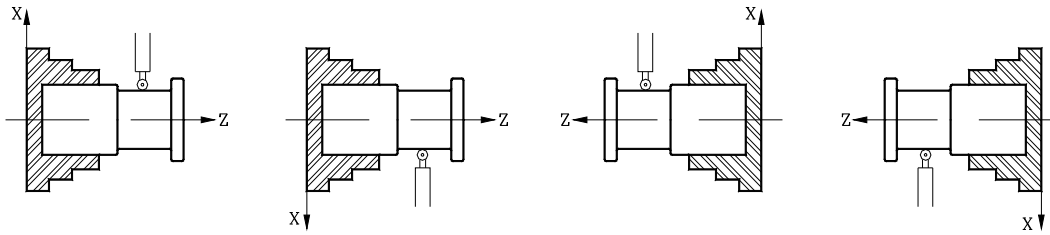

CODIGO F1

CODE F1

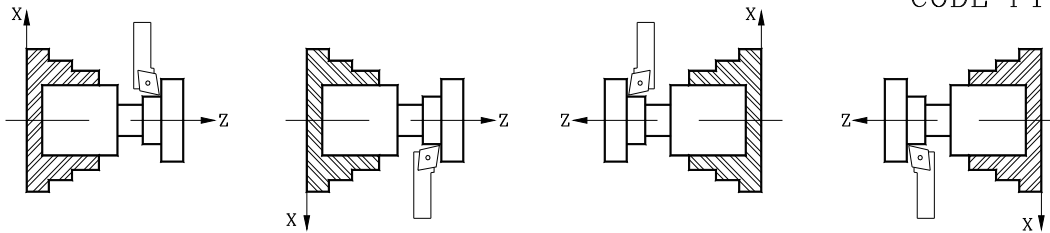

CODIGO F2

CODE F2

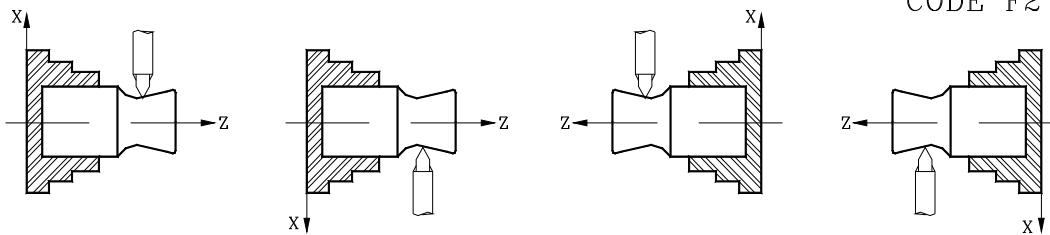

CODIGO F3

CODE F3

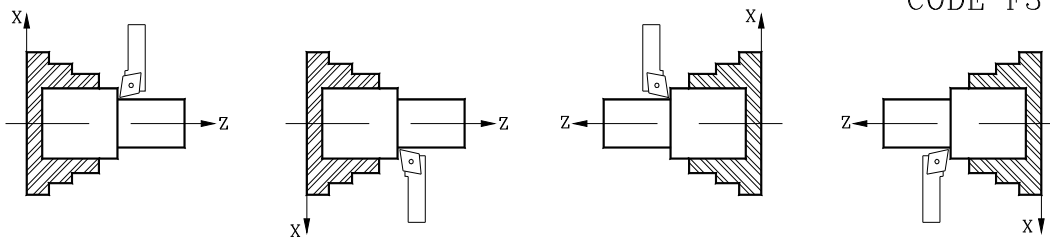

CODIGO F4

CODE F4

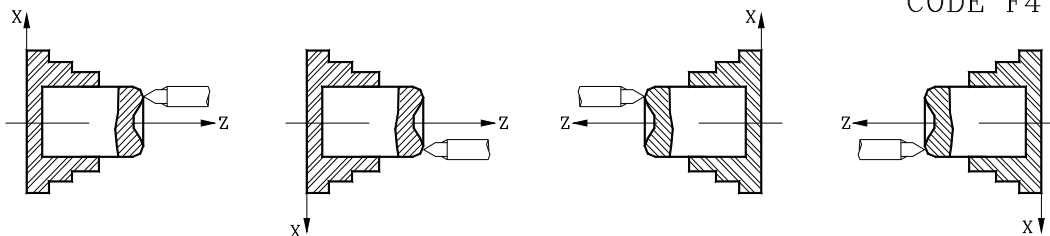

7.

TABLES
Tool Offset table



CNC 8055
CNC 8055i

.T. MODEL
SOFT: V01.3x

7.

TABLES
Tool Offset table

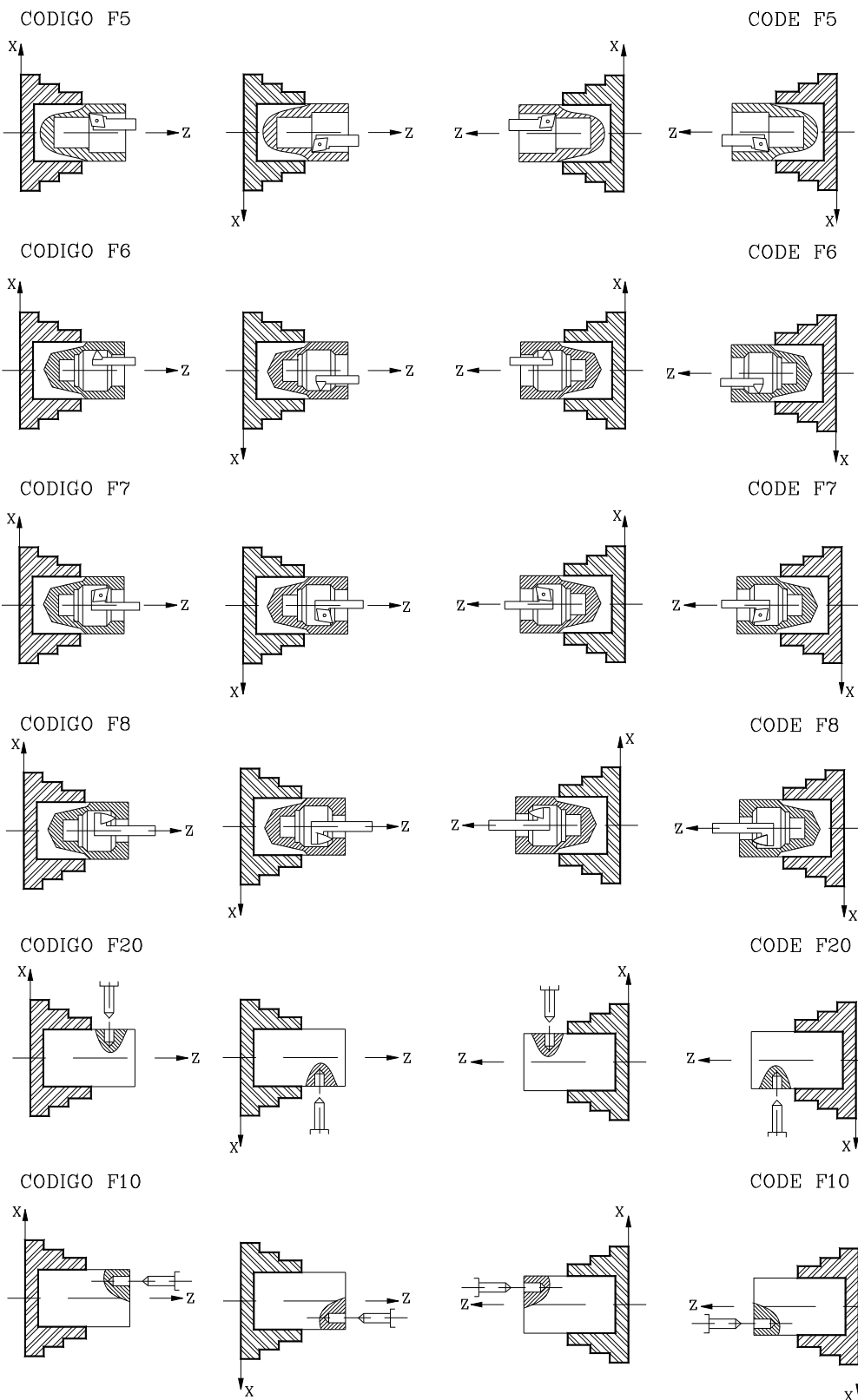

CNC 8055
CNC 8055i

-T- MODEL
SOFT: V01.3x

7.5 Tool geometry table.

This table contains information such as cutter angle, cutting angles, etc. regarding the geometry of the available tools.

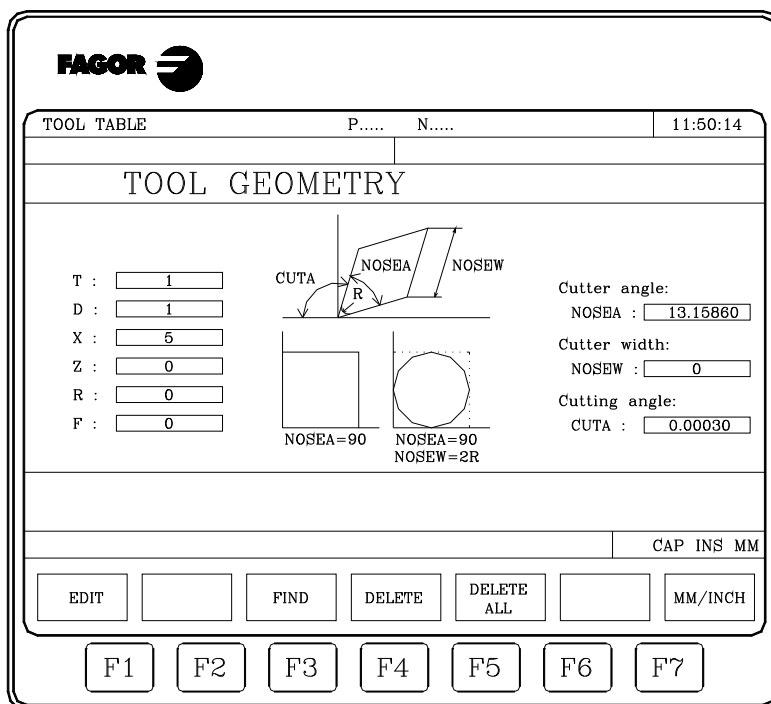

The data corresponding to each tool is contained in the following fields:

Tool data contained in other tool tables:

- "T" Tool number.
- "D" Associated tool offset number (tool table)
- "X" Tool length along X axis (tool offset table).
- "Z" Tool length along Z axis (tool offset table).
- "R" Radius of the cutter (tool offset table)
- "F" Location code or type of tool (tool offset table).

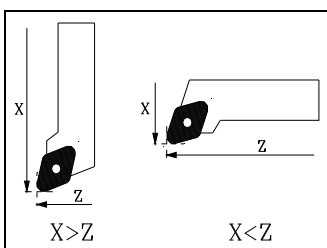

If the "X" length assigned to a tool is greater than the "Z" length value, the CNC will show a tool with a vertical handle and when "X" is shorter than "Z", with a horizontal handle.

Cutter angle (NOSEA).

Indicates the angle formed by the sides of the cutter and it is given in degrees.

7.

TABLES
Tool geometry table.

Cutter width (NOSEW).**Cutting angle (CUTA).**

The parameters corresponding to the cutter angle (NOSEA) and the cutter width (NOSEW) must always be defined.

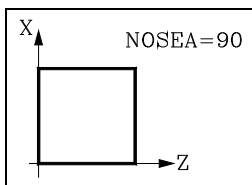

When the cutter is square, its angle value will be 90o (NOSEA = 90).

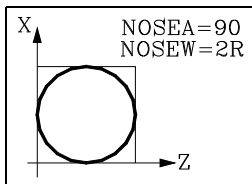

When the cutter is round, the cutter angle will be 90o (NOSEA=90) and the parameter corresponding to the cutter width must be assigned its diameter value (NOSEW = 2R).

The cutting angle (CUTA) must only be defined when the selected tool type (location code "F") is F1, F3, F5 or F7.

If the selected tool type is F0 or F9, it is not necessary to define any parameter and if it is F1, F3, F5 or F7, the following parameters must be defined: the cutter angle (NOSEA), the cutter width (NOSEW) and the cutting angle (CUTA).

When the selected tool type is F2, F4, F6 or F8, only the cutter angle (NOSEA) and width (NOSEW) must be defined.

When using a drill bit or end-mill, Tool type (location code) F10 must be used being necessary to define the values of of NOSEW (cutter width) and NOSEA (cutter tip angle).

7.

TABLES
Tool geometry table.



CNC 8055
CNC 8055i

.T. MODEL
SOFT: V01.3x

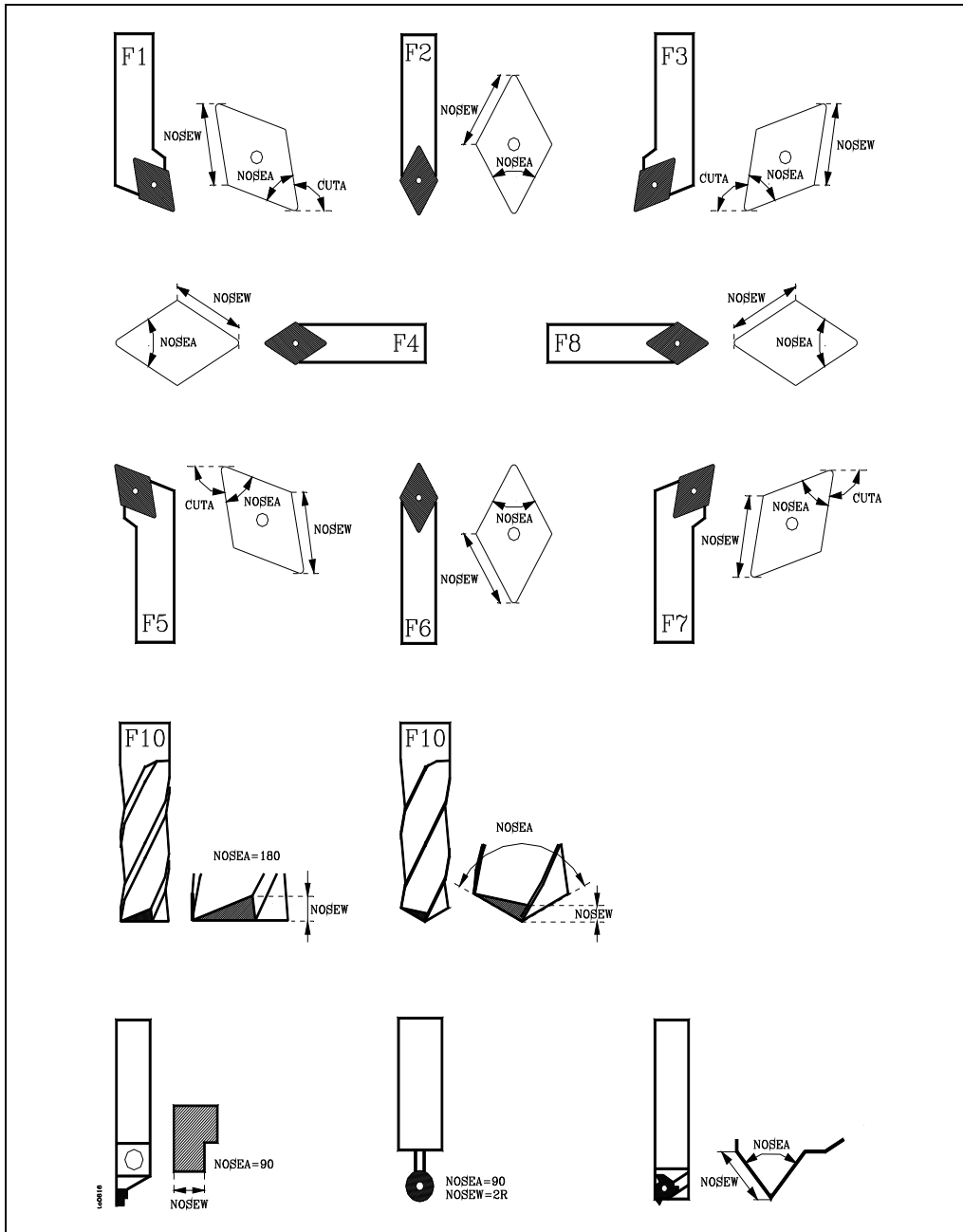

7.

TABLES
Tool geometry table.



CNC 8055
CNC 8055i

-T- MODEL
SOFT: V01.3x

7.5.1 How to edit the tool geometry table

Once the tool geometry table is selected, the following options are available:

"EDIT" softkey

The softkeys will change their background color to white and they will offer the following options:

- Cutter angle.
- Cutter width.
- Cutting angle.
- Previous menu.. To return to the to the tool geometry menu.

Press [ESC] to quit the geometry editing mode and return to the for the tool table.

"FIND" softkey

It is possible to select a new geometry table. The CNC will request the number of the tool or offset associated with the geometry is to be displayed.

"DELETE" softkey

With this option, it is possible to delete the geometry of the displayed tool setting to 0 its NOSEA, NOSEW and CUTA field values.

"CLEAR ALL" softkey

This option may be used to delete the geometry of all the tools defined in the tool table.

The CNC will set to 0 the NOSEA, NOSEW and CUTA fields of all the tools defined in the tool table.

"MM/INCHES" softkey

Every time this softkey is pressed, the CNC will change the display units for the coordinates corresponding to the tool geometry (X, Z, R). The lower right-hand side window shows the units selected (MM/INCH).

7.

TABLES
Tool geometry table.



CNC 8055
CNC 8055i

-T- MODEL
SOFT: V01.3x

7.6 Global and local parameters tables

The CNC has two types of general purpose variables:

- Local parameters P0-P25 (7 levels).
- Global parameters P100-P299.

The CNC updates the parameter tables after carrying out the operations indicated in the block in preparation. This operation is always carried out before executing the block. Therefore, the values shown in the table may not coincide with those of the block being executed.

If the execution mode is abandoned after interrupting the execution of the program, the CNC will update the parameter tables with values corresponding to the block that was being executed.

In the global and local parameter tables, the values of the parameters may be displayed in decimal (4127.423) or in scientific notation (0.23476 E-3).

The CNC generates a new nesting level of local parameters every time parameters are assigned to a subroutine. Up to a maximum of 6 nesting levels of local parameters are possible.

When the machining canned cycles: G66, G68, G69, G81, G82, G83, G84, G85, G86, G87, G88 and G89 are active, they use the sixth nesting level of local parameters.

To access the different local parameter tables, the corresponding level must be indicated (0 through 6).

While programming in high level, local parameters may be referred to as P0-P25, or as A-Z, "A" being the same as "P0" and "Z" the same as "P25".

That is why the local parameter tables show the parameter number next to their associated letter (between parenthesis). In the tables, the parameter can only be referred to as P0-P25, letters are not allowed.

7.

TABLES
Global and local parameters tables

FAGOR 

**CNC 8055
CNC 8055i**

·T· MODEL
SOFT: V01.3x

7.7 How to edit tables

It is possible to move the cursor line by line using the [↑] [↓] keys or page by page using the Page-up and Page-down keys.

There are several ways to edit or modify a line that will be described next.

Once any of those options has been selected, the user can move the cursor over this line by means of the [←] [→] keys. Also, with the [↑] key, the cursor may be placed over the first character of the editing window and, with the [↓] key over the last character.

7.

TABLES
How to edit tables

"EDIT" softkey

Once this option has been selected, the softkeys change color appearing over a white background and they show the information corresponding to the type of editing that may be done.

Also, editing help will be available at any time by just pressing the [HELP] key. To quit this help mode, press [HELP] again.

Press [ESC] to quit the editing mode and maintain the table with the previous values.

Once the editing is done, press [ENTER]. The values assigned will be entered into the table.

"MODIFY" softkey

Once this option has been selected, the softkeys change color appearing over a white background and showing the information corresponding to each field.

Also, editing help will be available at any time by just pressing the [HELP] key. To quit this help mode, press [HELP] again.

By pressing [ESC], the information shown in the editing area is deleted. From this point on, the selected line may be edited again.

To quit the block modifying mode, press [CL] or [ESC] to clear the editing window and then press [ESC] again. The table will keep its previous values.

Once the modification is over, press [ENTER]. The new values assigned will be entered into the table.

"FIND" softkey

When selecting this option, the softkeys will show the following options:

- STARTING When pressing this softkey, the cursor is placed over the first line of the table that can be edited.
- END When pressing this softkey, the cursor is placed over the last line of the table.
- Zero offset, tool offset, tool, position, parameter
 When pressing one of these softkeys, the CNC requests the field number to be found. Once the field has been defined, press [ENTER].

The CNC searches for the requested field and places the cursor over it (when found).

"DELETE" softkey

When deleting a line, the CNC sets all the fields to "0".

To delete a line, indicate its number and press [ENTER]

To delete several lines, indicate the beginning, press the [UP TO] softkey, indicate the last line to be deleted and press [ENTER]

To delete all the lines, press the "ALL" softkey. The CNC will request confirmation of the command.



CNC 8055
CNC 8055i

.T. MODEL
SOFT: V01.3X

"INITIALIZE" softkey

Resets all the table data to "0". The CNC will request confirmation of the command.

"LOAD" softkey

The tables may be loaded from the hard disk (KeyCF™) or a peripheral device or a PC through the serial line (RS232C).

The transmission starts after pressing the corresponding softkey. When using a serial line, the receptor must be ready before starting the transmission.

To interrupt the transmission, press the "ABORT" softkey.

If the length of the table received does not coincide with the current table length, the CNC will act as follows:

- If the table received is shorter than the current one, the received lines are modified and the rest remain with their previous values.
- If the table received is longer than the current one, all the lines of the table are modified and when detecting that there is no more room, the CNC will issue the corresponding error message

"SAVE" softkey

The tables may be saved into the hard disk (KeyCF™) or a peripheral device or a PC through the serial line (RS232C).

The transmission starts after pressing the corresponding softkey. When using a serial line, the receptor must be ready before starting the transmission.

To interrupt the transmission, press the "ABORT" softkey.

"MM/INCHES" softkey

It toggles the display units for the data. The lower right-hand side window shows the units selected (MM/INCH).

7.

TABLES
How to edit tables

FAGOR 

**CNC 8055
CNC 8055i**

.T. MODEL
SOFT: V01.3x

7.

TABLES

How to edit tables



CNC 8055
CNC 8055i

·T· MODEL
SOFT: V01.3x

In this operating mode, one can access the programs stored in the CNC's RAM memory, in the hard disk (KeyCF), in the USB disk and in external devices through the serial line.

They can be deleted, renamed or their protection changed. It is also possible to make copies within the same device or from one to another.

The contents of the storage devices may be shown in two ways:

1. Using the explorer.
2. Without using the explorer.

There are two options to set how to access the explorer:

- Via the <utilities> softkey.
- From the softkeys <execute>, <simulate> or <edit>.

Accessing the explorer this way does not allow certain operations.

Advanced access

G.m.p EXPLORER (P180) sets how to access the explorer.

8.1 Accessing the programs without using the explorer

8.1.1 Directory

To access the part-program directory of the RAM memory, hard disk (KeyCF), USB disk and of the external devices (serial line). The subroutine directory of the CNC can also be accessed.

Program directory

By default, the CNC shows the program directory of the RAM memory, to view another directory, press the corresponding softkey.

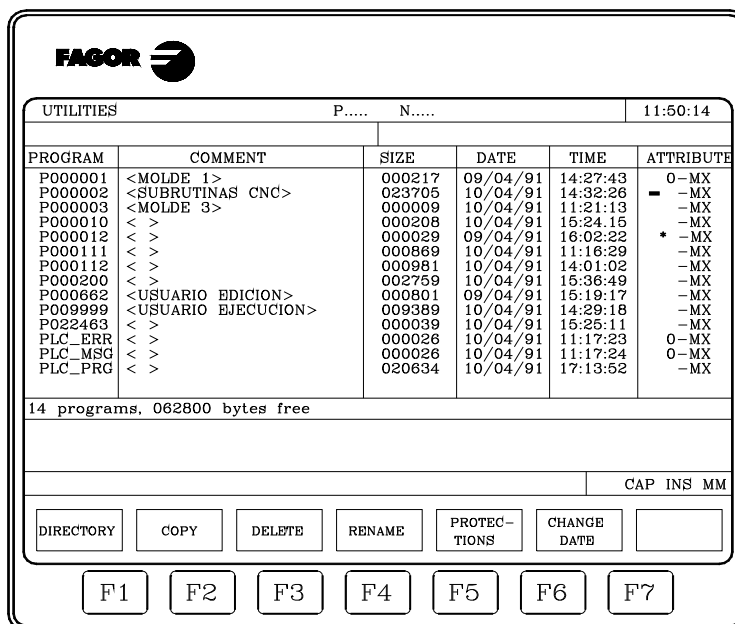

On each directory, the CNC shows all the programs visible (not hidden) to the user, that is:

- Part programs
- Screen customizing programs
- The PLC program (PLC_PRG)
- The PLC error file (PLC_ERR)
- The PLC message file (PLC_MSG)

The program directory has the following definition fields:

Program

It shows the number when it is a part-program or a customizing program and the corresponding mnemonic when it is a PLC program, the PLC error file or the PLC message file.

Comment

Any program may have a comment associated with it for its identification.

The comments may be defined when editing the program or in this operating mode using the Rename option as described later on.

Size

It indicates, in bytes, the size of the program text. It must be borne in mind that the actual size of the program is slightly greater because this field does not include the space occupied by some variables used internally (header, etc.).

Date and time

The date and the time when the program was edited (last changed).

8.

UTILITIES

Accessing the programs without using the explorer



CNC 8055
CNC 8055i

.T- MODEL
SOFT: V01.3X

Attributes

They show information about the source and usefulness of each program. The attributes are defined in this operating mode by means of the "Protections" option as described later on.

- * The program is running, either because it is the main program or because it contains a subroutine which has been called upon from that program or from another subroutine.
- O The program was created by the machine manufacturer (OEM).
- H The program is hidden and cannot be displayed in any directory.
However, a hidden program may be deleted or modified if its number is known; therefore, it is recommended to remove the modifiable attribute (M) in order to prevent the operator from changing or deleting that program.
- M The program may be modified. In other words, it may be edited, copied, etc.
If a program does not have this attribute, the operator cannot see or modify its contents.
- X Indicates that the program may be executed.
A program not having this attribute cannot be executed by the operator.

When showing the attributes of each program, it will only show the letters of the fields that are selected, and it will show the character "-" when they're not.

Example:

- O - -X Indicates that the program was created by the manufacturer, it will be displayed in the directory (not hidden), it cannot be modified, but it may be executed.

Subroutine directory

It lists all the subroutines defined in the part programs of the CNC ordered from the smallest one to the largest one. Also, next to the subroutines, it displays the number of the program where it has been defined.

UTILITIES		P.....	N.....			11:50:14	
SUBR	PROG	SUBR	PROG	SUBR	PROG	SUBR	PROG
0001	P000002	0002	P000002	0003	P000002	0004	P000002
0005	P000002	0006	P000002	0013	P000002	0014	P000002
0015	P000002	0016	P000002				
10 Subroutines							

If the program containing the subroutine has the "hidden" attribute assigned to it, that program number will appear as P??????.



UTILITIES
Accessing the programs without using the explorer



CNC 8055
CNC 8055i

.T- MODEL
SOFT: V01.3x

Directory of the external devices

When accessing the directory of an external device through the serial line, that directory is shown in DOS format.

The "CHANGE DIR" softkey lets the user select the work directory of the PC to operate with from the CNC. This operation does not change the work directory that was selected to operate with from the PC. In other words, when operating via DNC, it is possible to select a work directory at the PC and a different PC directory at the CNC.

8.**UTILITIES**

Accessing the programs without using the explorer



CNC 8055
CNC 8055i

.T. MODEL
SOFT: V01.3x

8.1.2 Copy

To copy programs in the same directory or between directories of different devices.

To make a copy, proceed as follows:

1. Press the "COPY" softkey.
2. Indicate the location of the program or programs to be copied.
The CNC's RAM memory, hard disk (KeyCF), USB disk and external devices (serial line).
3. Indicate the number of the program to be copied.
Select the program with the arrow keys or key in its number and press [ENTER].
4. To copy several programs, press the softkeys "TO THE END" or "TO". In the case of "TO", indicate the number of the last program to be copied.
5. Press the "IN" softkey.
6. Indicate the destination of the copy.
The CNC's RAM memory, hard disk (KeyCF), USB disk and external devices (serial line).
7. When copying a single program, a different number may be selected for the destination program.
8. Press [ENTER].

If a program with the same number already exists, the CNC will display a warning message. On the other hand, if that program is in execution, the CNC will display a message indicating that it is not possible.

Two subroutines cannot have the same name in the RAM memory. To make a copy and change the name of the copied subroutine, write the subroutine defining block as a comment before making the copy.

Examples:

- Copy program 200103, from the CNC's RAM memory out to the hard disk (KeyCF) with the number 14.

COPY	(MEMORY)	P200103	IN
IN	(HARD DISK)	P14	ENTER

- Copy from program 102100 to the end, from the CNC's RAM memory out to the hard disk (KeyCF).

COPY	(MEMORY)	P102100	(TO THE END)
IN	(HARD DISK)	ENTER	

8.

UTILITIES
Accessing the programs without using the explorer



CNC 8055
CNC 8055i

.T. MODEL
SOFT: V01.3x

8.1.3 Delete

It is possible to protect programs stored in the CNC's RAM memory, in the hard disk (KeyCF), USB disk or in the external device.

To delete a program, proceed as follows:

1. Press the [DELETE] softkey
2. Indicate the location of the program or programs to be deleted.
The CNC's RAM memory, hard disk (KeyCF), USB disk and external devices (serial line).
3. Indicate the number of the program to be deleted.
Select the program with the arrow keys and press [ENTER] or key in its number .
4. To delete several programs, press the softkeys "TO THE END" or "TO", in the case of "TO" indicate the number of the last program to be deleted.
5. Press [ENTER].

Only programs that can be modified ("M" attribute) can be deleted.

Examples:

- Delete program 200103 from the hard disk (KeyCF):

```
DELETE      (HARD DISK)      P200103      ENTER
```

- Delete from program 123123 to program 123456, from the CNC's RAM memory.

```
DELETE      (MEMORY)        P123123      (TO)         P123456      ENTER
```

8.

UTILITIES

Accessing the programs without using the explorer



CNC 8055
CNC 8055i

-T- MODEL
SOFT: V01.3x

8.1.4 Rename

To rename or assign a new comment to a program stored in the CNC's RAM memory, in the hard disk (KeyCF) or in the USB disk.

To rename a program, proceed as follows:

1. Press the "RENAME" softkey.
2. Indicate the location of the program or programs to be renamed.
The CNC's RAM memory, hard disk (KeyCF), USB disk and external devices (serial line).
3. Indicate the number of the program to be renamed.
4. Select the program with the arrow keys and press [ENTER] or key in its number and press the "TO" softkey.
5. Press the softkey NEW NUMBER or NEW COMMENT.
6. Enter the new number or the new comment and press [ENTER].

The files associated with the PLC (program, messages and errors) are always referred to with their associated mnemonics, thus only their comments may be renamed.

If there is a program with the same number, the CNC will issue a warning message and it will offer the chance to modify the command.

Examples:

- To change the name of program 200103 of the hard disk (KeyCF).

RENAME	(HARD DISK)	P200103	
A	NEW NUMBER	P12	ENTER

- To change the comment of program 100453 from the CNC

RENAME	(MEMORY)	P100453	
A	NEW PROFILE	"HELLO"	ENTER



UTILITIES
 Accessing the programs without using the explorer



CNC 8055
CNC 8055i

.T. MODEL
SOFT: V01.3x

8.1.5 Protections

To prevent certain programs from being manipulated and restrict access to the operator to certain CNC commands.

It is possible to protect programs stored in the CNC's RAM or in the hard disk (KeyCf).

User permissions

Lets the operator see those CNC programs that have been created by the operator and sets their attributes.

To modify the attributes of a program, proceed as follows:

1. Press the [USER PERMISSION] softkey.
2. Indicate the program number.
If it is in another directory, press the corresponding softkey.
Select the program with the arrow keys or key in its number and press [ENTER].
3. Press the following softkeys

F2	to change the (H) attribute	program visible (not hidden)
F3	to change the (M) attribute	modifiable program
F4	to change the (X) attribute	executable program
4. Press the [ENTER] key.

OEM Permission

Lets see all the programs stored at the CNC whether they are created by the OEM or by the operator and set their attributes.

To modify the attributes of a program, proceed as follows:

1. Press the "OEM PERMISSION" softkey.
2. Indicate the program number.
If it is in another directory, press the corresponding softkey.
Select the program with the arrow keys or key in its number and press [ENTER].
3. Press the following softkeys

F1	to change the (O) attribute	OEM program
F2	to change the (H) attribute	program visible (not hidden)
F3	to change the (M) attribute	modifiable program
F4	to change the (X) attribute	executable program
4. Press the [ENTER] key.

Passwords

Lets define each of the passwords that the operator must key in before accessing the various CNC commands.

- General password (MASTERPSW)
It is requested when trying to access this password option.
(Utilities mode / Protections / Passwords).
- OEM password (OEMPSW)
It is requested when trying to access OEM permissions
(Utilities mode / Protections / OEM permissions).

8.

UTILITIES

Accessing the programs without using the explorer



CNC 8055
CNC 8055i

.T. MODEL
SOFT: V01.3X

- User password (USERPSW)
It is requested when trying to access user permissions
(Utilities mode / Protections / User permissions).
- PLC access password (PLCPSW)
It is requested in the following cases:
When compiling the PLC program.
When trying to change the status of a resource or execute a program execution controlling command.
To protect the PLC program, the PLC message program and the PLC error program, modify their attributes so they are "Non-modifiable".
- Customizing password (CUSTOMPSW)
It is requested when trying to access the Customizing mode or when attempting to erase an OEM screen.
- Machine parameter access password (SETUPPSW)
It is requested when trying to access the options to modify the table values (Edit, Modify, Initialize, Delete and Load) except for tables of the serial lines which are not protected.

To change or delete the passwords, use the following softkeys:

Change passwords.

Select the desired password and enter the new one.

Delete password.

Lets delete (eliminate) one of several codes from the table.

To delete a password, indicate its number and press [ENTER].

To delete several passwords (they must be in a row), indicate the number of the first one to be delete, press the "UPTO" softkey, indicate the number of the last one to be deleted and press [ENTER].

To delete a password, indicate its number and press [ENTER].

Clear all.

Lets delete all the passwords. The CNC will request confirmation of the command and it will delete them after pressing [ENTER].



UTILITIES

Accessing the programs without using the explorer



CNC 8055
CNC 8055i

.T. MODEL
SOFT: V01.3x

8.1.6 Change date

Lets change the system date and time.

It will first show the date in the CNC's day/month/year format (12/04/2009). After changing it, press [ENTER] to validate it. If it is not to be changed, press [ESC].

It will then show the time in the CNC's hour/minutes/seconds format (08/30/00). After changing it, press [ENTER] to validate it. If it is not to be changed, press [ESC].

8.

UTILITIES

Accessing the programs without using the explorer



CNC 8055
CNC 8055i

-T- MODEL
SOFT: V01.3x

8.2 Accessing the programs using the explorer

Accessing the explorer displays a window divided in two areas (left panel and right panel) as shown in the next figure:

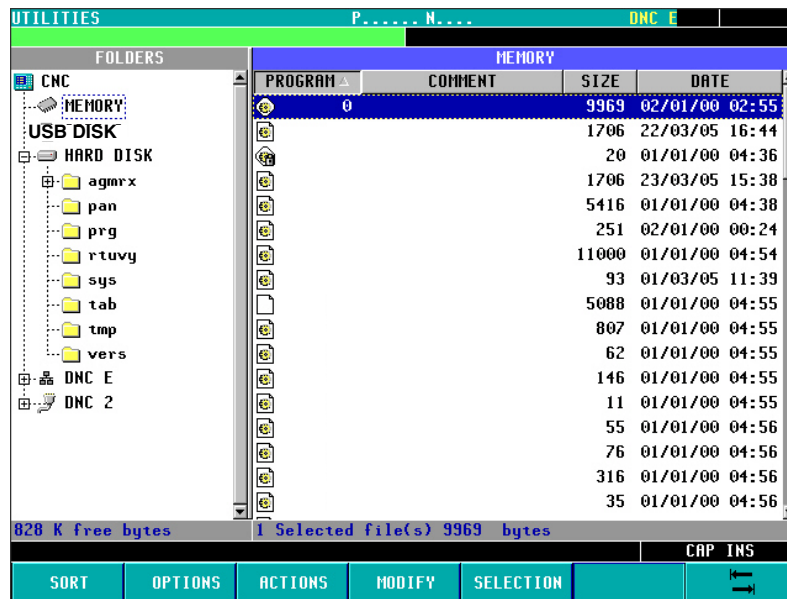

Left panel ► FOLDERS

This side of the window shows all the devices available at the CNC:

- Memory
- Hard disk (KeyCF)
- USB disk
- Remote hard disk
- DNC 2
- DNC E

If a device DNC is not connected, the explorer will display the device, but it will issue the message "device (unit) not available" when trying to access its contents.

The devices include their own folders. Using the explorer, it is possible to view the real folder structure (tree). Thus, the user can display the subdirectories Tab, Prg, Pan, ...

The subdirectories of the DNC units will only show the stored user programs.

Right panel ► DEVICE

This side of the window shows the contents of the folder previously selected in the left panel. Only the CNC programs (*.pim or *.pit) stored in the selected folder will be displayed. Any other type of file that this folder may contain will not be shown.

The fields to the right of each program indicate the program number, its size, date/time it was created and attribute.

8.

UTILITIES
Accessing the programs using the explorer

FAGOR 

CNC 8055
CNC 8055i

.T. MODEL
SOFT: V01.3x

The attribute of a program is identified depending on the icon appearing in the "program" field.



By default, the programs will appear sorted by number in ascending order and the PLC files will be at the end: errors, messages and programs.

They can also be sorted by comment, date/hour and size, both in ascending or descending order using the <SORT> softkey. The options displayed are:

- By number [N]
- By comment
- By size
- By date

The bottom of the screen shows how much memory is available in each device (unit) and how many programs are currently selected as well as their total size.

Hidden user files can also be shown using the USERPSW password in the <access codes> window. To display all the files, enter the password OEMPSW.

Program handling

A program is considered to be selected on the file list of the right panel when the cursor is on it.

The keys for moving the cursor are:



F7 - Cursor movement inside the right/left panels of the explorer.



Up/down arrow keys.



Folder expand/shrink keys of the left panel of the explorer.

SHIFT +



Move the cursor to the first program.

SHIFT +



Move the cursor to the last program.

Use the number keys of the CNC to select the program with the desired number. If there is no program with that number and the programs are sorted by number, the cursor will select the program with the nearest lower number.

The operations that may be carried out on the programs displayed by the explorer at the time are:

Rename

To rename the selected program as long as it is a modifiable program. After modified, its date/time will change.

To rename a program, select it first in the right panel and after pressing the <Modify> softkey, >number< option displays the <Rename> window with the new text frame "new number" where the new name can be written.

No program may be renamed in DNC 2/E.

Modify comment

To rename the comment of the selected program as long as it is a modifiable program. The comment must not exceed 20 characters. After modified, its date/time will change.

To change the comment of a program, first select it in the right panel and after pressing the <Modify> softkey >comment< option, it shows the text box "new comment" where the new comment may be written.

No comment of a program may be renamed in DNC 2/E.

Modifying permissions

It may be used to modify the OEM, hidden, executable and read-only permissions of programs that are displayed at the time in the explorer. Thus, if it is an OEM program, it will request an OEM password and if a program is assigned the <hidden> attribute, its relevant icon immediately appears on the list of the explorer. After modified, its date/time will change.

To change the permission of a program, first select it in the right panel and after pressing the <Modify> softkey >permissions< option, it shows the text box "new comment" where the new comment may be written.

No permission of a program may be renamed in DNC 2/E.

Delete

It may be used to delete a previously selected program. Only a modifiable program may be deleted.

To delete a program, first select it in the right panel and after pressing the <Actions> softkey, >[CLEAR]< option, it will disappear from the program listing displayed in the explorer.

Copy

It copies the selected program onto the clipboard. First select the program to be copied in the right panel and press the <Actions> softkey <Copy [C]> option. Then, select the destination folder and press the <Paste [V]> option located under the same >Actions< softkey.

Cut/move

It copies the selected program onto the clipboard. First select the program to be cut/move in the right panel and press the >Actions< softkey <Cut [X]> option. Then, select the destination folder and press the <Paste [V]> option located under the same >Actions< softkey. Once the content of the clipboard has been pasted, the files will be deleted from the source folder and moved to the new destination.

These operations are carried out using the horizontal softkeys shown at the bottom of the screen and can only be carried out on the programs being displayed on the screen.



Operations on sets

The user may select a set of programs that are located in the right panel of the screen. This selection may be done either individually or by range or as a whole.

These types of selection may be carried out after pressing the <Select> softkey and any of the options shown depending on the task to be carried out. The available options are:

- All / Nothing [*]
- From / To [_]
- Select [+]
- Deselect [-]
- Invert

After selecting the programs individually, by range or as a whole, it is possible to carry out on them the operations mentioned earlier.



Some operations may not be applicable to certain programs of the selection. In those cases, the user will be informed and will be allowed to either resume or cancel the operation.

Handling the directories

When the cursor is located on any of the "hard disk" or "remote hard disk" units of the left panel, any of the following actions may be carried out on any of them:

- Create a subdirectory
- Rename a subdirectory
- Delete a subdirectory



To delete a subdirectory, it must be empty.

Quick access to directories

Selecting a directory in the left panel and pressing the <Options> softkey, >Save position [M]<, the explorer will remember this directory.

After selecting this option and having moved the cursor to another directory, pressing the <Options> softkey, <Go to position [G]> option, the cursor of the explorer will automatically position in the saved directory. Pressing the same softkey again, the explorer will return to the starting position.

Quick access keys (hot keys)

Some options of the softkeys have a hot key. A hot key carries out the same function as the option itself. When displaying the menu of each softkey, it shows the hot key (between square brackets) equivalent to the option.

Not all the options of the softkeys have an associated hot key.

8.

UTILITIES

Accessing the programs using the explorer



CNC 8055
CNC 8055i

-T- MODEL
SOFT: V01.3x

Each softkey of this operating mode shows the following information.

SOFTKEY	Meaning
CNC	Program number and line that was being executed last time an execution error or a power outage occurred.
DNC	Information and statistics of the DNC communication lines. Establish the connection with a remote PC to carry out telediagnosis tasks.
Sercos	Information and statistics of the Sercos communication.
CAN	Information and statistics of the CAN communication.

9.1 CNC

This screen shows the number of the line that was being executed last time an execution error or a power outage occurred. The CNC shows the program number and line number that was executing as well as where the program is stored.

If that program called a subroutine and the CNC was executing it, it will show the subroutine number, the program containing it and the line or block of the subroutine that it was executing.

Device	Program	Line number	Subroutine
HARD DISK	000012	7	
MEMORY	001000	15	0033

The CNC was executing line 7 of program 12 stored in the hard disk.
 That program called subroutine 33 and the CNC was executing line 15 of that subroutine.
 The subroutine is defined in program 1000 that is stored in the CNC's RAM memory.

Error register

The CNC's error register is accessed with the softkey "BB". This register saves an error history indicating the error number and when it occurred.

The SAVE softkey may be used to save the register into a file. By pressing this softkey, the CNC requests the number of the program to store that information.



CNC 8055
 CNC 8055i

-T- MODEL
 SOFT: V01.3x

9.1.1 Data backup copy. Backup - Restore

This option may be used to make a backup copy of the CNC configuration data to be restored later on if necessary.

The general backup and restore may be carried out on any device:

- Hard disk (KeyCF).
- DNC.
- USB disk.



*Doing a Backup or Restore via DNC requires configuring the "work folder" and "work folder of the CNC operator" inside SETUP / MODIFICAR of the WinDNC.
If these folders are missing, the CNC will not find the device.*

Configuring the backup options

Accessing <STATUS> / <CNC> / <BACKUP/RESTORE>, it is possible to select either the "Backup" or "Restore" option. After selecting one of these two options, an explorer window appears for selecting the source/target of the Backup/Restore operation.

The selected configuration is saved for the next time "Backup/Restore" is used.

This screen shows a table for selecting everything that is to be saved or restored.

OEM programs

PLC program, MSGFILE program, CFGFILE program, STPFILE, USR* program, PLC messages and PLC errors.

If any of the programs described is not an OEM program, it will request confirmation to make it OEM. If you chose not to make it OEM, it will not be saved.

OEM and hidden programs will be saved encrypted. When doing the Backup, OEM and hidden programs are encrypted based on the OEM password. If the Restore is carried out on a CNC with a different OEM password, the CNC will issue the error message "the program is protected" and will not allow restoring it.

CNC tables and parameters

Tables for zero offsets, tool offsets, tools, arithmetic parameters and geometry.

General machine parameters, for axes, spindles, serial lines, ethernet and hard disk, PLC, M functions, for leadscrew error compensation and cross compensation.

Screens

".PAN" files: customized screens generated with the WINDRAW55 program.

Servo drive parameters

Parameters for all the drives.

This field is only shown when using a Sercos or CAN servo drive system. These parameters are saved to and restored from the drives.

User programs

Visible and hidden user programs.

The same screen shows the softkeys to start the Backup and the Restore: <BEGIN BACKUP> and <BEGIN RESTORE>. It also shows other softkeys such as OEM data, options or modify.



*If an error occurs, the CNC will request confirmation to resume copying.
Backup and Restore via WINDNC (including screens) requires WINDNC version V5.1 or greater.
Otherwise, the CNC will display the corresponding error.*

Backup

Backup is carried out using the <BEGIN BACKUP> softkey.

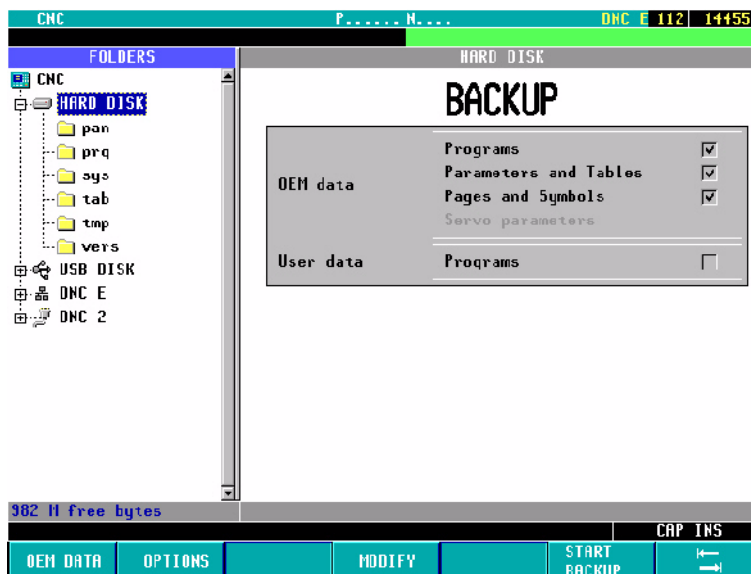

Pressing this softkey makes a safety copy (backup) of the data contained in the indicated folder. The data is saved in the selected file.

Several backups may be done in different folders in the same unit (Hard disk, USB disk, etc.).

When doing a Backup, each file goes to its corresponding folder (PRG, TAB or PAN). If these folders are missing, they will be created.

Backup is not possible in a subfolder PRG, TAB or PAN, only the folder containing these subfolders may be selected.

When doing a Backup, the data is copied in the following devices:

- Screens: from the hard disk (KeyCF).
- Servo drive parameters: from CAN / SERCOS drives.
- In the rest of the CNC files: from RAM memory.



CNC 8055
CNC 8055i

-T- MODEL
SOFT: V01.3X

Restore

The backup data is restored using the <BEGIN RESTORE> softkey.



When doing a Restore, the data is restored in the following devices:

- Screens: on hard disk (KeyCF)
- Servo drive parameters: at the drives.
- In the rest of the CNC files: in RAM memory.

If servo drive tables or parameters have been selected, the emergency must be activated while doing a Restore. Otherwise, corresponding error will be issued.

When Restore is done, the CNC is restarted.

If the drives are not on, the CNC will issue the relevant warning.

If during Restore, there are errors in the table data, the message window will display them in green.

The Restore operations will be registered in the CNC status register.

OEM data

The <OEM DATA> softkey may be used to select/deselect all the OEM data.

- OEM programs.
- CNC tables and parameters.
- Screens.
- Servo drive parameters.

After selecting the desired OEM data, it is possible to back them up or restore them using the <BACKUP> or <RESTORE> softkeys.



CNC 8055
CNC 8055i

.T. MODEL
SOFT: V01.3x

9.2 DNC

The CNC grants access to this operating mode when having Ethernet connection or when the serial line (RS232C) has been set to work in DNC mode.

From this mode, it is possible to know the status of the serial line and the Ethernet configuration as well as activating or deactivating the DNC modes. It is also possible to make a telephone call to a remote PC to carry out telediagnosis tasks.

Turning the DNC on/off

The bottom of the screen shows softkeys with the following options for the serial line:

- DNC ON Activates the serial line.
- DNC OFF Deactivates the serial line.

The activation/deactivation of this operating mode is made dynamically, therefore, if, when deactivating the DNC mode, you are transmitting via this channel, the CNC aborts the transmission and deactivates the DNC.

Regardless of this operating mode, the OEM can set by machine parameter whether the DNC mode will be active or not on power-up.

Status of the serial line

The following information is shown for the serial line:

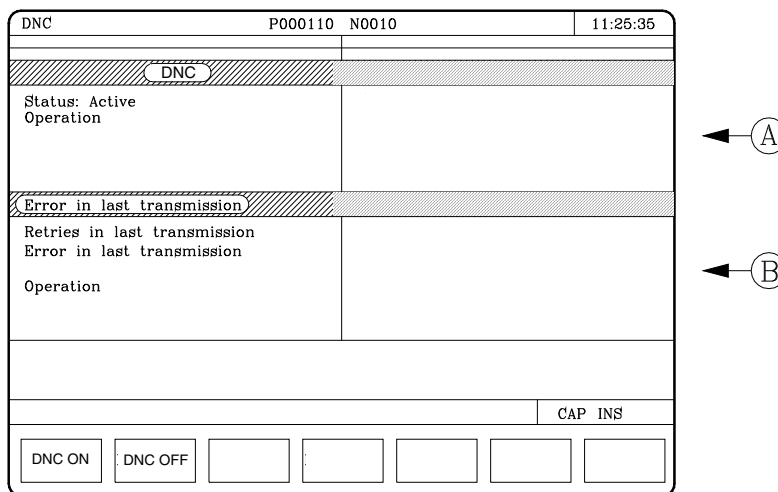

In this example, the serial line is used to communicate via DNC.

The upper area (A) indicates:

- The status of the serial line. Active / Inactive.
- The type of operation in progress.
Sending program / Receiving program / Sending directory / Receiving directory / etc.

The lower area (B) indicates the last operation and the type of error occurred if any.

Diagnosis of the Ethernet connection

The screen for Ethernet status shows the following information.

ETHERNET		P..... N....		DNC	12:24:55
NET					
MAC	00:0B:CB:10:00:10	MASK	255.255.0.0		
DIRIP	10.0.17.70	GATEWAY			
ETHERNET NOT RUNNING					
RECEPCION					
Packs	767	Errors	0	Lost	0
Overrun	0	Frame	0		
TRANSMISION					
Packs	1980	Errors	0	Lost	0
Overrun	0	Collisions	1	Carrier	0
FTP Active					
REMOTE HARD DISK		Active			
					CAP INS

- The top of the screen shows the network configuration (MAC or Ethernet address, IP address, network mask and the IP address of the gateway).
When detecting an error in the configuration, it will show the corresponding error message.
- The mid area of the screen shows the information on data transmission and reception. With a green background the fields that must be 0 when working fine.
- The bottom of the screen shows the data of the active services.
For the remote hard disk, it shows the IP address and the shared directory. If there is no remote hard disk or there is an error, it shows the corresponding error message.

9.

STATUS
DNC



CNC 8055
CNC 8055i

.T. MODEL
SOFT: V01.3x

9.2.1 Phone call (telediagnosis)

The "phone call" softkey may be used to communicate a CNC with a remote PC to carry out telediagnosis tasks. See chapter ["14 CNC - PC Communication. Telediagnosis"](#).

To establish communication, both the CNC and the PC must be connected to a modem. The remote PC must have the WinDNC software installed in it.

The CNC offers the following types of phone call.

- Normal phone call.
It is a direct phone call between the CNC and the PC. Whoever establishes the connection incurs in its costs.
- Advanced phone call.
It is a direct phone call between the CNC and the PC. Whoever establishes the connection incurs in its costs.
This option is similar to the previous one, but it provides faster telediagnosis. This type of connection uses TCP/IP protocol, thus not being necessary to configure an incoming connection at the PC.
- Internet phone call.
It is a connection made through internet. Both the CNC and the PC incur in the connection costs because both the CNC and the PC must be connected to the internet.
Telediagnosis through the Internet offers all the advantages of this type of connection. Usually, this type of connection costs less than a direct telephone call. When connecting through the Internet for the connection, the telediagnosis may sometimes be slower than making a direct telephone call.

Dialing with pulses or tones

The softkey menu permits selecting whether to dial using pulses or tones.

9.

STATUS
DNC

CNC 8055
CNC 8055i

·T· MODEL
SOFT: V01.3x

9.3 Sercos

The CNC grants access to this operating mode when the Sercos bus has been defined. It shows information and statistics on the incidences occurred in the Sercos communication.

This mode has been especially designed for the Service Department.

The data on a green background must have a "0" value if everything is OK.

Pressing the "LOG FILE" softkey shows a history of the errors occurred till then, time, error number and its description.

The SAVE softkey may be used to save that error history into a file.



CNC 8055
CNC 8055i

·T· MODEL
SOFT: V01.3x

9.4 CAN

The CNC grants access to this operating mode when the CAN bus has been defined. It shows information and statistics on the incidences occurred in the CAN communication.

This mode has been especially designed for the Service Department.

The main screen shows:

- Information on each node.

Node ID	Node identifier.
Reported inputs	Number of inputs detected.
Reported outputs	Number of outputs detected.
Rx errors	Reception errors.
Tx errors	Transmission errors
Lost messages.	
Stage	Stage (phase) of the communication status. Value of 5 if OK

- CNC information.

Stage	Stage (phase) of the communication status.
CAN speed.	
Rx errors	Reception errors.
Tx errors	Transmission errors
Lost messages.	
Number of retries.	
Status	For the Fagor Service Department.
Input cycle	For the Fagor Service Department.

- Number of analog inputs/outputs and PT100.

Analog inputs.
Analog outputs.
PT100 inputs.

The data on a green background must have a "0" value if everything is OK.

Pressing the "LOG FILE" softkey shows a history of the errors occurred till then, time, error number and its description.

The SAVE softkey may be used to save that error history into a file.

Pressing the VERSION softkey displays a screen that shows:

- The software version installed in each node. SW version, Date and Checksum.
- The hardware version for the node: HV version.
- The CAN software version installed at the CNC: SW version and Checksum.

There are softkeys to update or copy the CNC's CAN software in each of the Fagor modules. This operation may be carried out module by module or in all of them at the same time.



CNC 8055
CNC 8055i

-T- MODEL
SOFT: V01.3x

In this operating mode, the PLC may be accessed to check its operation or the status of its variables. It is also possible to edit or analyze the PLC program as well as the message or the error files of the PLC.

The accessible programs associated with the PLC are:

- The PLC program (PLC_PRG)
- The PLC error file (PLC_ERR)
- The PLC message file (PLC_MSG)

The PLC program (PLC_PRG) may be edited at the front panel or copied from the hard disk (KeyCF) or from a PC as described in the "Utilities" chapter.

The PLC program (PLC_PRG) is stored in the internal CNC memory with the part-programs and it is displayed in the program directory (utilities) together with the part-programs.

Before executing the PLC_PRG program, it must be compiled. Once it is done compiling, the CNC requests whether the PLC should be started or not. To make the operator life easier and avoid new compilations, the source code generated at each compilation is stored in memory.

After power-up, the CNC acts as follows:

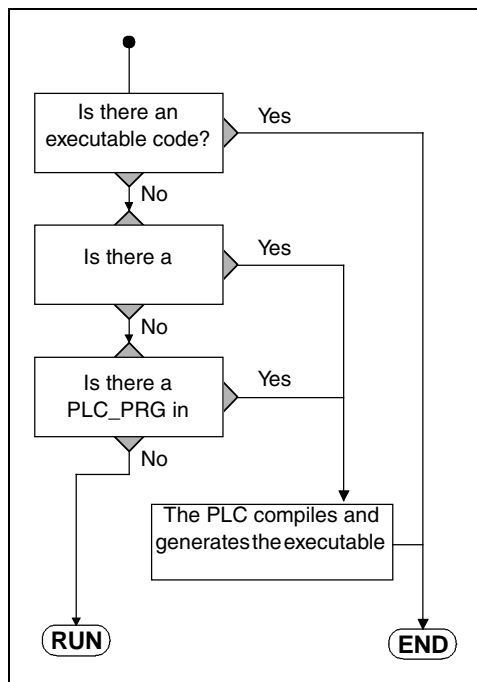

Runs the executable program stored in memory.

If there isn't one, it compiles the PLC_PRG program already in memory and runs the resulting executable program.

If it is not there, it looks for it in the hard disk (KeyCF).

If it isn't in the hard disk (KeyCF) either, it does nothing. Later on, when accessing the jog mode, execution mode, etc. the CNC will issue the corresponding error message.

Once the program has been compiled, it is not necessary to keep the source program (PLC_PRG) in memory because the PLC always executes the executable program.

Once the proper performance of the PLC has been verified, it is a good idea to save it into the hard disk (KeyCF) using the instruction SAVE PROGRAM (as described later on).



CNC 8055
CNC 8055i

.T. MODEL
SOFT: V01.3x

10.1 Edit

Once this option is selected, indicate with the corresponding softkey the PLC program to be edited.

- The PLC program (PLC_PRG)
- The PLC error file (PLC_ERR)
- The PLC message file (PLC_MSG)

The cursor can be moved line by line with the [↑] [↓] arrow keys or page by page with the "page up" and "page down" keys.

The cursor position or line number will be displayed in a white window inside the communications window next to the CAP/INS indicator window.

This operating mode offers various options that are described next.

Once any of those options has been selected, the user can move the cursor over this line by means of the [←] [→] keys. Also, with the [↑] key, the cursor may be placed over the first character of the editing window and, with the [↓] key over the last character.

"EDIT" softkey

With this option it is possible to edit new lines or blocks of the selected program. Before pressing this softkey, the block after which the new ones will be added must be selected with the cursor.

Once this option has been selected, the softkeys will change colors and they will appear over white background showing the information corresponding to the type of editing possible at that point.

Pressing the [ESC] key deletes the block being edited. From this point on, the block may be edited again.

Once the block has been edited, press [ENTER]. This new block will be added to the program after the one indicated by the cursor.

The cursor will position over the new edited block and the editing area (window) will be cleared so another block can be written.

The editing area must be empty in order to quit this option. If it's not, press [ESC] to delete that information and then press [ESC] again.

"MODIFY" softkey

This option permits modifying the contents of a selected program block. Before pressing this softkey, select with the cursor the block to be modified .

Once this option is selected, the softkeys will change their color showing their type of modifying option over a white background.

By pressing the [ESC] key, the information corresponding to that block and which was shown in the editing area will be cleared. From this point on, the block may be edited again.

To quit the block modifying mode, press [CL] or [ESC] to clear the editing window and then press [ESC] again. This way, the selected block will not be modified.

Once the block contents have been modified, press [ENTER]. The new block will replace the previous one.

"FIND" softkey

This option is used to find a specific text within the selected program. When selecting this option, the softkeys will show the following options:

BEGINNING

This softkey positions the cursor over the first program block which is then selected quitting the "find" option.

10.

PLC
Edit



CNC 8055
CNC 8055i

.T. MODEL
SOFT: V01.3X

END

This softkey positions the cursor over the last program block which is then selected quitting the "find" option.

TEXT

With this function it is possible to search for a text or character sequence starting at the current cursor position.

When this softkey is pressed, the CNC requests the character sequence to be found. Once this text has been keyed in, press the "END OF TEXT" softkey and the cursor will position over the first occurrence of the keyed text.

The search will begin from the block the cursor is position on beginning at that block. The text found will be highlighted being possible to continue with the search or to quit it.

Press [ENTER] to continue the search up to the end of the program. The CNC will begin the search at the last text found and it will highlight it.

The search can be done as many times as desired. Once searched to the end of the program, it will continue the search from the beginning.

Press the "ABORT" softkey or the [ESC] key to quit the search mode. When quitting the search mode, the cursor will be positioned at the last matching text found.

LINE NUMBER

After selecting this softkey, the CNC will request the number of the line to be found. After keying in the desired number and pressing [ENTER], the cursor will position over that block which will then be selected quitting the search mode.

"REPLACE" softkey

With this option it is possible to replace a character sequence with another throughout the selected program. When selecting this option, the CNC requests the character sequence to be replaced. Once the text to be replaced is indicated, press the "WITH" softkey and the CNC will request the character sequence which will replace the previous one.

Once this text is keyed in, press the "END OF TEXT" softkey and the cursor will be positioned over the first occurrence of the searched text.

The search will begin from the block the cursor is position on beginning at that block. The found text will be highlighted and the following softkey options will appear:

REPLACE

It will replace the highlighted text and will continue the search for the indicated text. The new text found will be highlighted and the softkeys will show the same "replacing" or "not replacing" options.

This search will be carried out from the text that was replaced up to the end of the program. If no more occurrences of the text to be replaced are found, the CNC will quit this mode.

DO NOT REPLACE

It will NOT replace the highlighted text and will continue the search for the indicated text. The new text found will be highlighted and the softkeys will show the same "replacing" or "not replacing" options.

This search will be carried out from the text that was replaced up to the end of the program. If no more occurrences of the text to be replaced are found, the CNC will quit this mode.

TO THE END

This option will find and replace the selected text throughout the whole program.

This "find and replace" will start at the highlighted text and will go on to the end of the program.

ABORT

This option will not replace the highlighted text and it will quit the "find and replace" mode.

10.PLC
Edit**FAGOR** **CNC 8055**
CNC 8055i-T- MODEL
SOFT: V01.3x

"DELETE BLOCK" softkey

With this function it is possible to delete a block or group of blocks.

To delete only one block, just position the cursor over it and press [ENTER].

To delete a group of blocks, indicate the first and last blocks to be deleted. To do that, proceed as follows:

1. Position the cursor over the first block to be deleted and press the "INITIAL BLOCK" softkey.
2. Position the cursor over the last block to be deleted and press the "FINAL BLOCK" softkey. If the last block to be deleted is also the last one of the program, it can also be selected by pressing the "TO THE END" softkey.

Once the first and last blocks are selected, the CNC will highlight the selected blocks requesting confirmation to delete them.

"MOVE BLOCK" softkey

With this option it is possible to move a block or group of blocks by previously indicating the first and last blocks to be moved. To do that, proceed as follows:

1. Position the cursor over the first block to be moved and press the "INITIAL BLOCK" softkey.
2. Position the cursor over the last block to be moved and press the "FINAL BLOCK" softkey. If the last block to be moved is also the last one of the program, it can also be selected by pressing the "TO THE END" softkey.

To move only one block, the "initial block" and the "final block" will be the same one.

Once the first and last blocks are selected, the CNC will highlight the selected blocks requesting confirmation to move them.

Then, indicate the block after which this group of blocks must be placed. Press the "START OPERATION" softkey to carry out this command.

10.PLC
EditCNC 8055
CNC 8055i-T- MODEL
SOFT: V01.3x

"COPY BLOCK" softkey

With this option it is possible to copy a block or group of blocks by previously indicating the first and last blocks to be copied. To do that, proceed as follows:

1. Position the cursor over the first block to be copied and press the "INITIAL BLOCK" softkey.
2. Position the cursor over the last block to be copied and press the "FINAL BLOCK" softkey. If the last block to be copied is also the last one of the program, it can also be selected by pressing the "TO THE END" softkey.

To copy only one block, the "initial block" and the "final block" will be the same one.

Once the first and last blocks are selected, the CNC will highlight the selected blocks requesting confirmation to copy them.

Then, indicate the block after which this group of blocks must be placed. Press the "START OPERATION" softkey to carry out this command.

"COPY TO PROGRAM" softkey

With this option it is possible to copy a block or group of blocks of one program into another program.

When selecting this option, the CNC will request the number of the destination program where the selected block or blocks are to be copied. After entering the program number press [ENTER].

Next, indicate the first and last blocks to copy. To do that, proceed as follows:

1. Position the cursor over the first block to be copied and press the "INITIAL BLOCK" softkey.
2. Position the cursor over the last block to be copied and press the "FINAL BLOCK" softkey. If the last block to be copied is also the last one of the program, it can also be selected by pressing the "TO THE END" softkey.

To copy only one block, the "initial block" and the "final block" will be the same one.

Once the first and last blocks are selected, the CNC will highlight the selected blocks and will execute the command.

If the destination program already exists, the following options will be displayed:

- Write over the existing program. All the blocks of the destination program will be erased and will be replaced by the copied blocks.
- Append (add) the copied blocks behind the ones existing at the destination program.
- Abort or cancel the command without copying the blocks.

"INCLUDE PROGRAM" softkey

With this option it is possible to include or merge the contents of another program into the one currently selected.

Once this option is selected, the CNC will request the number of the source program to be merged. After entering the program number press [ENTER].

Next, indicate with the cursor the block after which the source program will be included.

Press the "START OPERATION" softkey to carry out this command.

10.

PLC
EditFAGOR CNC 8055
CNC 8055i.T. MODEL
SOFT: V01.3x

10.2 Compile

With this option it is possible to compile the PLC source program "PLC_PRG". Once the source program compiled, the CNC will generate the executable PLC program (object program).

The PLC program must be stopped in order to compile it, otherwise, the CNC will "ask" if it is desired to stop it.

If while compiling, some errors are detected, the CNC will not create the object program and the detected errors will appear on the screen. The errors will be shown from the first one detected up to a maximum of 15 errors.

If the errors do not affect the proper program execution (such as non-referenced labels, etc.), the CNC will display the corresponding warning messages but it will generate the object program.

After a successful compilation, the CNC will "ask" whether the PLC program must be started or not.

10.PLC
Compile

CNC 8055
CNC 8055i

.T. MODEL
SOFT: V01.3x

10.3 Monitoring

With this option it is possible to display the PLC program and analyze the status of the different PLC resources and variables. PLC monitoring may be accessed from the conversational mode or from ISO mode writing 78.

Once this option has been selected, the CNC will show the source program that corresponds to the executable program (object) even when that program (source) has been deleted or modified at the CNC. The CNC will also display all the variable consultations at logic level 1 (including those not being executed) and the actions whose conditions are met.

To display the program from a specific line on, press the "L" key followed by that line number. Press [ENTER] once the line number has been correctly "typed in".

It is possible to move the cursor line by line using the [↑] [↓] keys or page by page using the Page-up and Page-down keys.

The various monitoring options available are described next.

Once any of those options has been selected, the user can move the cursor over this line by means of the [←] [→] keys. Also, with the [↑] key, the cursor may be placed over the first character of the editing window and, with the [↓] key over the last character.

Modify the status of the resources

The CNC has the following instructions to modify the status of the different PLC resources.

It must be borne in mind that when referring to a single resource, it is possible to do it using its corresponding mnemonic. For example, /STOP=1 is interpreted by the CNC as M5001=1.

I 1/256 = 0/1

Alters the status (0/1) of the indicated input.

For example: I120 = 0, sets input I120 to 0.

I 1/256.1/256 = 0/1

Alters the status (0/1) of a the indicated group of inputs.

For example: I100.103 = 1, sets inputs I101, I102 and I103 to 1.

O 1/256 = 0/1

Alters the status (0/1) of the indicated output.

For example: O20 = 0, sets output O20 to 0.

O 1/256.1/256 = 0/1

Alters the status (0/1) of the indicated group of outputs.

For example: O22.25= 1 sets outputs O22 thru O25 to 1.

M 1/5957 = 0/1

Alters the status (0/1) of the indicated mark.

For example: M330 = 0 sets Mark M330 to 0.

M 1/5957.1/5957 = 0/1

Alters the status (0/1) of the indicated group of marks.

For example: M400.403=1 sets marks M400 thru M403 to 1.

TEN 1/256 = 0/1

Alters the status (0/1) of the enable input of the indicated timer.

For example: TEN12 = 1, sets the enable input of timer T12 to 1.

TRS 1/256 = 0/1

Alters the status (0/1) of the reset input of the indicated timer.

For example: TRS2 = 0 sets the reset input of timer T2 to 0.

10.

PLC
Monitoring

FAGOR 

CNC 8055
CNC 8055i

.T. MODEL
SOFT: V01.3x

TGn 1/512 n = 0/1

Alters the status (0/1) of the trigger input "TGn" of the indicated timer (1 thru 512) assigning the desired time constant (n) to it.

For example: TG1 22 1000 sets the trigger input 1 of timer T22 to one and it assigns a time constant of 1000 (10 seconds).

CUP 1/256 = 0/1

Alters the status (0/1) of the UP count input of the indicated counter.

For example: CUP 33 = 0 sets the status of the UP input of counter C33 to 0.

CDW 1/256 = 0/1

Alters the status (0/1) of the DOWN count input (DW) of the indicated counter.

For example: CDW 32 = 1 sets the status of the UP input of counter C32 to 1.

CEN 1/256 = 0/1

Alters the status (0/1) of the enable input of the indicated counter.

For example: CEN 12 = 0, sets the enable input of counter 12 to 0.

CPR 1/256 n = 0/1

Alters the status (0/1) of the preset input of the indicated counter (1 thru 256). The counter will be preset with the value "n" if an up flank is produced with this instruction.

For example: CPR 10 1000 = 1 sets the status of the preset input of counter C10 to 1. On the other hand, if the state of this input has changed (it had to be 0 before), the counter will be preset to a value of 1000.

C 1/256 = n

Presets the count of the indicated counter to the "n" value.

For example: C42 = 1200 sets the count of counter C42 to 1200.

B 0/31 R 1/559 = 0/1

Changes the status (0/1) of the indicated bit (0/31) of the indicated register (1/559).

For example: B5 R200 = 0 sets Bit 5 of register R200 to 0.

R 1/559 = n

Assigns the (n) value to the indicated register.

For example: R 303 = 1200 assigns the value of 1200 to register R303.

R 1/559.1/559 = n

Assigns the (n) value to the indicated register group.

For example: R234.236 = 120 assigns the value of 120 to registers R234, R235 and R236.

Create window

This CNC allows the possibility of creating windows to display the status of the various PLC resources. These windows will be shown overlapping the PLC program and the information displayed in them will be updated dynamically.

The options "MODIFY WINDOW", "ACTIVE WINDOW" and "ACTIVATE SYMBOLS" allow the manipulation of these windows.

Every time a new window is created, the CNC will assign 2 data lines to it in order to display the status of the desired resources.

There are two types of windows which can be selected with softkeys.

Window to display timers and registers

This window is divided into two sections, one to display timers and the other one to display registers.

Timer.

It will show one timer per line showing the following information for each one of them:

TG Indicates the logic status of the active trigger input.

10.

PLC
Monitoring



CNC 8055
CNC 8055i

.T. MODEL
SOFT: V01.3X

M	Indicates the status of the timer: "S" means stopped, "T" means timing and "D" means disabled.
TEN	Indicates the logic status of the enable input.
TRS	Indicates the logic status of the enable input.
T	Indicates the logic status of the status output of the timer.
ET	Indicates the elapsed time.
TO	Indicates the remaining time.

Key in the command T 1/256 or T 1/256.1/256 to request the data on a timer or group of timers and then press [ENTER].

Register.

It will display one register per line showing the following information fields for each of them:

HEX	Indicates the hexadecimal value of its contents.
DEC	Indicates the decimal value of its contents (with sign).

Key in R 1/559 or R 1/559.1/559 to request information on one or more registers and, then, press [ENTER].

Window to display counters and binary data

This window is divided into two sections, one to display counters and the other one to display binary data.

Counters.

It will display one counter per line showing the following information fields for each of them:

CEN	Indicates the logic status of the enable input.
CUP	Indicates the logic status of the UP COUNT input.
CDW	Indicates the logic status of the DOWN COUNT input.
CPR	Indicates the logic status of the preset input.
S	Indicates the status of the counter. "1" when its internal count is 0 and 0 for all other cases.
C	Indicates its count value.

Key in C 1/256 or C 1/256.1/256 to request information on one or more counter and, then, press [ENTER].

Binary Data.

It will show one data line per resource or group of resources requested.

The instructions available to request information of the various resources are:

I 1/256 or I 1/256.1/256	Shows the status of the selected input or group of inputs.
O 1/256 or O 1/256.1/256	Shows the status of the selected output or group of outputs.
M 1/5957 or M 1/5957.1/5957	Shows the status of the selected mark or group of marks.
B 0/31 R 1/559	Shows the status of the selected bit of the indicated register.

When requesting the status of one or more inputs, outputs or marks, the CNC will show complete data lines even when all of them have not been requested.

When using generic denominators (I / O / M) to display resources, the CNC will display 20 of them per line and 3 when using their associated mnemonics (symbols).

When requesting the status of a register bit, the CNC will display only the requested bit on the corresponding line.

Modify window.

With this option it is possible to manipulate the active window (the one selected) by enlarging it, reducing it, clearing it or even eliminating (closing) it.

10.

PLC
MonitoringFAGOR CNC 8055
CNC 8055i-T- MODEL
SOFT: V01.3X

To do so, the following softkey options are available:

ENLARGE	To enlarge the size of the window by one line every time this softkey is pressed.
REDUCE	To reduce the size of the window by one line every time this softkey is pressed (minimum 2 lines).
CLEAR	To clear the contents of the active window.
CLOSE	To close the active window. When closing a window, the CNC will no longer display it.

10.

PLC
Monitoring

Active window.

With this option it is possible to select between the PLC program and each one of the windows being displayed (timers, registers, counters and binary data) in order to operate with it.

Bear in mind that the operator can only operate with the active window.

Once the active window has been selected, it will be possible to:

- Move the cursor (if the PLC program is the one active) or shift the display area with the [↑] [↓] keys.
- Execute any command of the "MODIFY WINDOW" option.

FIND

This option will be executed regardless of which is the active window and it offers the following searching options:

BEGINNING

This softkey positions the cursor over the first program block which is then selected quitting the "find" option.

END

This softkey positions the cursor over the last program line and quits the "find" option.

TEXT

With this function it is possible to search for a text or character sequence starting at the current cursor position. When this softkey is pressed, the CNC requests the character sequence to be found.

The CNC will consider a text found when it is between blank spaces or separators. Thus, When looking for "I1" it will not find or stop at "I12" or "I123", but only at "I1".

Once this text has been keyed in, press the "END OF TEXT" softkey and the cursor will position over the first occurrence of the keyed text.

The search will begin from the block the cursor is position on beginning at that block.

The text found will be highlighted being possible to continue with the search or to quit it.

Press [ENTER] to continue the search up to the end of the program. The CNC will begin the search at the last text found and it will highlight it.

The search can be done as many times as desired. Once searched to the end of the program, it will continue the search from the beginning.

Press the "ABORT" softkey or the [ESC] key to quit the search mode.

Activate / deactivate symbols

With this option it is possible to display in all available windows the symbols or mnemonics associated to the various resources.

The names of the resources may be displayed in two ways: using their generic names (I, O, M, T, C, R) by deactivating symbols or using their associated symbols by activating them.

When a resource has no mnemonic associated to it, it will always be displayed with its generic name.

This softkey will toggle between ACTIVATE SYMBOL and DEACTIVATE SYMBOL every time is pressed in order to show which option is available.

Logic analyzer

It is especially suited to help in the machine start-up and for troubleshooting errors and critical situations in signal behavior.

It is described in full detail later in this chapter.

PLC start-up

When selecting this option, the CNC will start executing the PLC program from the beginning, including the CY1 cycle.

The CNC does not execute this option when the PLC program is running.

First cycle

When selecting this option, the CNC will execute only the initial cycle of the PLC program (CY1).

The CNC does not execute this option when the PLC program is running.

Single cycle

When selecting this option, the CNC will execute the main cycle of the PLC program (PRG) only once.

The CNC does not execute this option when the PLC program is running.

STOP PLC

This softkey interrupts the execution of the PLC program.

Continue

This softkey resumes the execution of the PLC program.

Contacts

This option may be used to monitor the PLC program in ladder diagram.

10.

PLC
Monitoring

FAGOR 

CNC 8055
CNC 8055i

.T. MODEL
SOFT: V01.3x

10.3.1 Monitoring with the PLC in operation and with the PLC stopped

It must be borne in mind that the CNC initializes all physical outputs and the PLC resources on power-up, after the key sequence [SHIFT]+[RESET] and after detecting a watchdog error at the PLC.

The initialization process sets all resources to "0" except those active low. They will be set to "1".

During the monitoring of the PLC program and the various PLC resources, the CNC will always show the real values of the resources.

If the PLC is on, note that a program cycle is processed in the following way:

- The PLC updates the real input values after reading the physical inputs (from the electrical cabinet).
- It updates the values of resources M5000 thru M5957 and R500 thru R559 with the values of the CNC logic outputs (internal variables).
- It runs the program cycle.
- It updates the CNC logic inputs (internal variables) with the real values of resources M5000 thru M5957 and R500 thru R559.
- It assigns to the physical outputs (electrical cabinet) the real values of the corresponding "O" resources.
- It copies the real values of resources I, O, M into their own images.

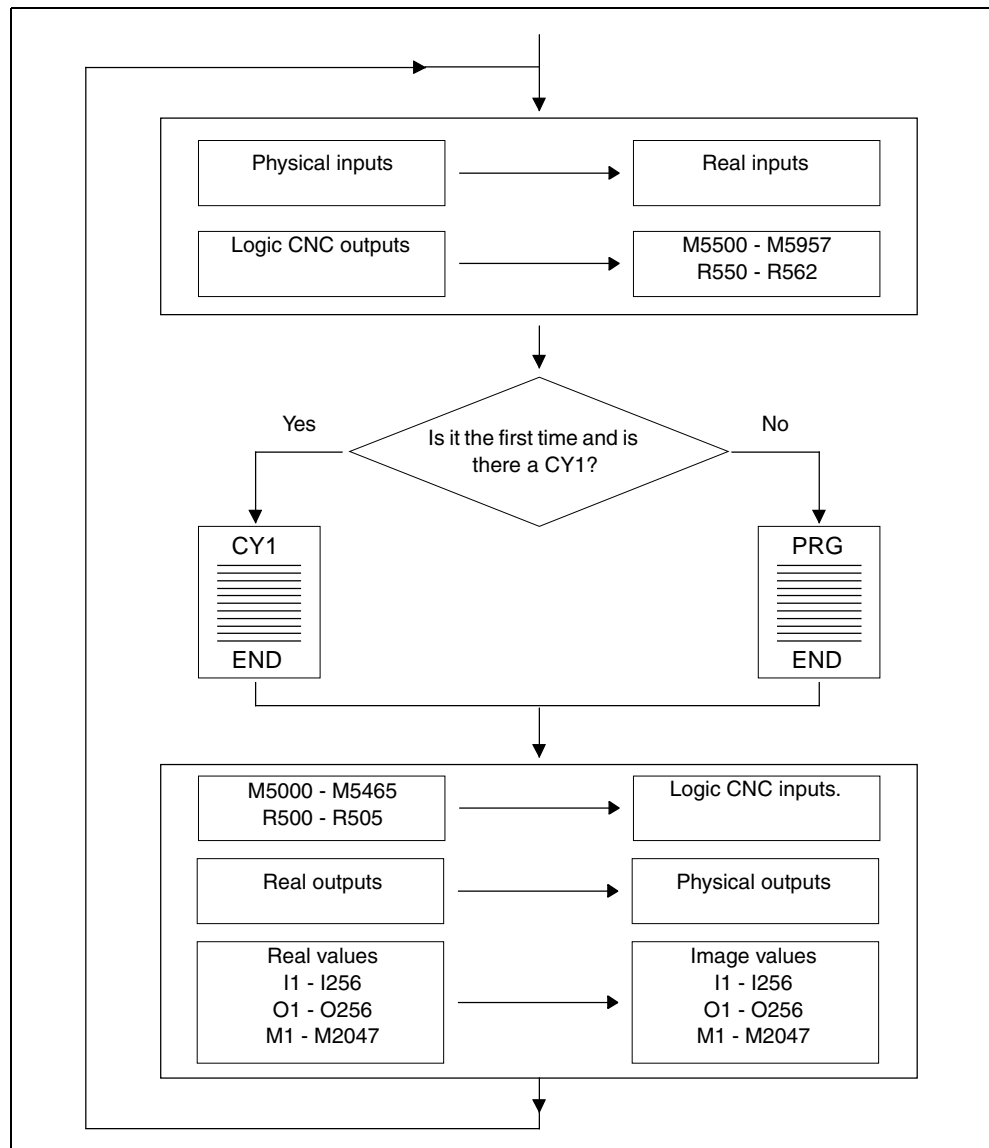

10.

PLC
Monitoring

CNC 8055
CNC 8055i

.T. MODEL
SOFT: V01.3x

If the PLC is stopped, it will work as follows:

- The real values of the "I" resources corresponding to the physical inputs will be updated every 10 milliseconds.
- The physical outputs will be updated every 10 milliseconds with the real values of the corresponding "O" resources.
- The PLC will attend to all requests and modifications of its internal variables.

10.

PLC
Monitoring

FAGOR 

CNC 8055
CNC 8055i

.T. MODEL
SOFT: V01.3x

10.3.2 PLC monitoring in ladder diagram language

Displaying the PLC program in ladder diagram requires a prior analysis whose duration depends on the size of the program and the CPU processing load.



It is not possible to analyze programs larger than the CNC memory capacity or programs with more than 10000 blocks.

The analysis is carried out only if the PLC program is compiled. The CNC will issue an error if the PLC program is not compiled when trying to analyze it.

The figure shows the PLC monitoring screen in ladder diagram. The left side shows the consultation contacts and the right side the contacts of the actions for the consultations of the block.

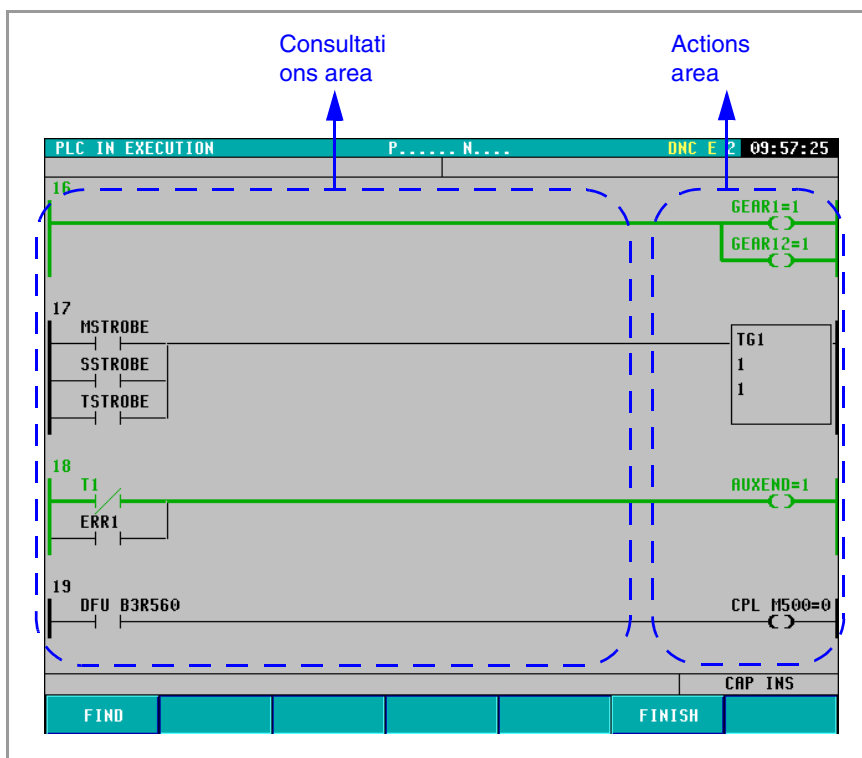

As shown in the figure, the instructions of the PLC program in ladder language is made up of elements connected to each other by segments. It also shows the logic way for the flow highlighted with a thicker green line and shows the values of registers, timers, counters, etc.

Use the [↑] [↓] [PAGE UP] [PAGE DOWN] keys to move from one block to another through the program.

The actions resulting from each block are shown on the right side of the screen (always in the same position). This way, if the block is longer than the width of the screen, the user can move through the left side of the program using the [←] [→] keys while the actions resulting from each block are always displayed on the right side of the screen.

"Find" softkey

This softkey may be used to run different kinds of searches in the PLC program in ladder diagram:

- BEGINNING:** Shows the first blocks of the PLC program in ladder diagram.
- END:** Shows the last blocks of the PLC program in ladder diagram.
- TEXT:** To search for the text indicated by the user. If there are several matches for the text, it highlights the first one in yellow. To see the rest of the texts found, use the softkey "PREVIOUS ELEMENT" and "NEXT ELEMENT".
- BLOCK:** It may be used to enter the block number to be displayed on the screen. The blocks are numbered sequentially. The block number is only displayed on the contact (ladder) monitoring screen.

10.

PLC
Monitoring



CNC 8055
CNC 8055i

.T- MODEL
SOFT: V01.3X

"Autozoom" softkey

The "Autozoom" softkey only appears when a block that is being monitored is too long and does not fit on the screen.

Pressing this softkey automatically adjusts the displayed blocks to the width of the screen. This way, the CNC shows the whole block without having to scroll it with the keys.

After having pressed the "Autozoom" softkey, if the blocks are too small, the CNC will not show the data of the elements. Also, if autozoom has been activated, it is not possible to scroll up and down toward blocks that are not displayed on the screen.

"Finish" softkey

It may be used to exit the PLC monitoring screen in ladder diagram.

Elements of the PLC program

As mentioned earlier, the instructions of the PLC program in ladder language is made up of elements connected to each other by segments. These elements may be the following:



*All the elements may appear in the PLC program in ladder language joined together in serial or in parallel.
Comments are not displayed when monitoring the PLC program in ladder language.*

Normally open contact:

The normally open contact is always displayed in the consultations area. Consults the logic state of a signal and, depending on the result, lets the flow pass or not.

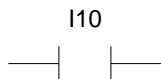

If I10 = 0, the contact is inactive and the flow does not pass.

If I10 = 1, the contact is active and the flow passes.

Normally closed contact:

The normally closed contact is always displayed in the consultations area. Consults the logic state of a signal and, depending on the result, lets the flow pass or not.

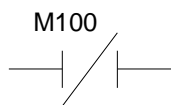

If M100 = 0, the contact is active and the flow passes.

If M100 = 1, the contact is inactive and the flow does not pass.

Relay coil:

The relay coil is always displayed in the actions area. It activates or deactivates depending on whether it receives the flow or not.

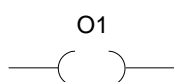

If the flow reaches the relay coil, it will be active and its value will be O1 = 1.

If the flow does not reach the relay coil, it will be inactive and its value will be O1 = 0.

10.

PLC
Monitoring

FAGOR

CNC 8055
CNC 8055i

.T. MODEL
SOFT: V01.3x

Negated relay coil:

The negated relay coil is always displayed in the actions area. It activates or deactivates depending on whether it receives the flow or not.

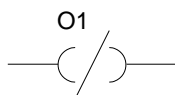

If the flow does not reach the relay coil, it will be active and its value will be $O1 = 1$.

If the flow reaches the relay coil, it will be inactive and its value will be $O1 = 0$.

Timing, comparing, counting, etc. operations:

This type of operations may appear in the actions area and in the consultations area. This type of operations execute the instruction shown inside the frame in PLC programming language

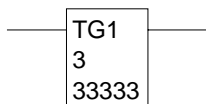
**10.**PLC
Monitoring

CNC 8055
CNC 8055i

·T· MODEL
SOFT: V01.3x

10.4 Active messages

When selecting this option, the CNC will display a page (or screen) showing dynamically all the active messages generated by the PLC.

These messages will be listed by priority always starting from the one with the smallest number (highest priority).

It is possible to move the cursor line by line using the [↑] [↓] keys or page by page using the Page-up and Page-down keys.

To delete one of the displayed messages, select it with the cursor and press the "DELETE MESSAGE" softkey.

Note that the CNC dynamically updates the active messages.

10.5 Active pages (screens)

When selecting this option, the CNC will show the active page with the lowest number.

To delete a page or access the other active pages, the CNC will display the following softkey options:

NEXT PAGE	Press this softkey to display the next active page.
PREVIOUS PAGE	Press this softkey to display the previous active page.
CLEAR PAGE	Press this softkey to deactivate the page being displayed.

Note that the CNC dynamically updates the active pages.

10.6 Save program

Press this softkey to save the PLC_PRG program into the hard disk (KeyCF).

The PLC program must be compiled. If it is not, the CNC will show a warning.

If the PLC program is running, the CNC requests it to be stopped.

10.PLC
Active messages**FAGOR** **CNC 8055
CNC 8055i**-T- MODEL
SOFT: V01.3x

10.7 Restore program

Select this option for the CNC to restore the PLC_PRG program from the hard disk (KeyCF).

The PLC program must not be running any PLC program, otherwise, the CNC will ask whether it is desired to stop it or not.

After executing this instruction, the new source program recovered will replace the one that the PLC previously had. This new one must be compiled and started in order for the PLC to execute it.

10.

PLC

Restore program

10.8 Resources in use

When selecting this option, the CNC will offer the softkeys to select the table of resources used in the PLC program.

The following resource tables are available:

- INPUTS (I)
- OUTPUTS (O)
- MARKS (M)
- REGISTERS (R)
- TIMERS (T)
- COUNTERS (C)



CNC 8055
CNC 8055i

-T- MODEL
SOFT: V01.3x

10.9 Statistics

This option shows the PLC memory distribution, the execution time of the various PLC modules, the PLC program status and the date when it was edited.

PLC IN EXECUTION		P.....	N.....	11:50:14
* GENERAL CYCLE - TIME (ms)		* SRAM MEMORY (bytes)		
- Minimum Cycle	1	- Installed	65536	
- Maximum Cycle	32	- Free	60528	
- Average Cycle	19			
- Watchdog	65536			
* PERIODIC MODULE - TIME (ms)		* HARD DISK		
- Minimum Cycle	*****	- Source program saved	**/**/****	
- Maximum Cycle	*****	- Date	*****	
- Average Cycle	*****	- Size		
- Frequency	*****	- Source program saved	**/**/****	
- Watchdog	*****	- Date	*****	
		- Size		
* STATUS		* SOURCE PROGRAM		
- Execution	IN PROGRESS	- Date	20/09/1998	
- Compiled	SI	- Size	3893	
- PLC time (PLC/total)	(0,2/32)			
				CAP INS MM
<input type="text"/> <input type="text"/> <input type="text"/> <input type="text"/> <input type="text"/> <input type="text"/> <input type="text"/>				
<input type="button" value="F1"/> <input type="button" value="F2"/> <input type="button" value="F3"/> <input type="button" value="F4"/> <input type="button" value="F5"/> <input type="button" value="F6"/> <input type="button" value="F7"/>				

10.

PLC
Statistics

General cycle

This section shows the time (maximum, minimum and average) it takes the PLC to execute a program cycle. Bear in mind that this time includes:

- Updating the resources with the values of the physical inputs and internal CNC variables.
- The execution of both the main cycle (PRG) and the periodic module if it is executed during the cycle.
- Updating the internal CNC variables and the physical outputs with the resource variables.
- Copying the resources into their corresponding images.

This section also shows the watchdog time selected by the PLC machine parameter "WDGPRG".

Periodic module

This section shows the time (maximum, minimum and average) that it takes to execute the periodic module of the PLC.

It also shows the period assigned to this module by means of the directive instruction "PE t". This period indicates how frequently the periodic module will be executed.

It also shows the watchdog time for this module selected by the PLC machine parameter "WDGPER".

Status

Provides information on the PLC program status indicating whether it is compiled or not and whether it is stopped or in execution.

In the "PLC time (PLC/total)", the numerator indicates the time used by the PLC and the denominator the total time set.

Example: CPUTIME=1, LOOPTIME=4. It will display the text "PLC time (PLC/total) (0.2/16)".



CNC 8055
CNC 8055i

.T. MODEL
SOFT: V01.3x

RAM memory

This section indicates the system's RAM memory available for the exclusive use of the PLC (installed) and it also indicates how much free memory there is.

The object program (executable) is obtained when compiling the source program and is the one executed by the PLC. This section shows the date when it was generated and the RAM memory space it occupies (size).

Hard disk (KeyCF)

This section also shows the date the PLC program (PLC_PRG) was saved into the hard disk (KeyCF) and its size.

Source program

This section indicates the date when the PLC source program was last edited and its size.

The PLC source program is stored in the CNC's RAM memory.

Time reset

Pressing the TIME RESET softkey initialized the minimum, maximum and average time values of the PRG and PE modules and starts measuring the times from that instant.

Application examples:

- When the statistics are not exact because the first PLC cycle has high time values.
- To know the duration of the PLC cycle from a particular moment, e.g. after having changed a parameter.

10.PLC
Statistics

CNC 8055
CNC 8055i

·T· MODEL
SOFT: V01.3x

10.10 Logic analyzer

The logic analyzer is especially suited to help in the machine start-up and for troubleshooting errors and critical situations in signal behavior.

This option is used to analyze the behavior of the logic PLC signals according to a time base and certain trigger conditions set by the user.

Up to 8 signals can be analyzed at the same time. The results are shown using a graphic interface that makes it easy to interpret the data.

10.10.1 Description of the work screen

The screen for the logic analyzer is divided into the following areas or display windows:

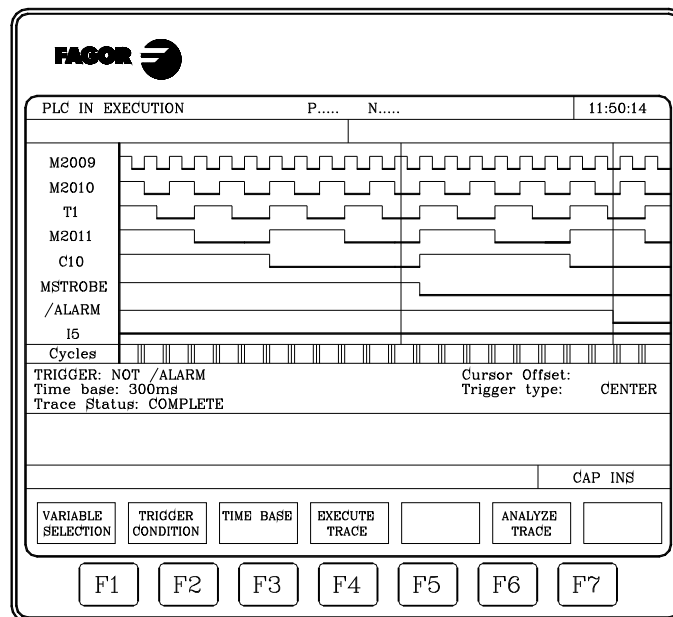

1. Status window.

It graphically shows the status of each selected signal. It is divided into two areas: Variables area and status area.

The variables area shows the names or symbols of the logic signals to be analyzed.

The status area shows the status of each variable in square waves. The line for logic level 0 is shown with a thicker line.



Likewise, it shows a vertical red line to indicate the TRIGGER point and another green vertical line to indicate the cursor position.

The vertical green line for the cursor may be moved along the trace and helps measure the time between two points of the trace.

The status area is divided into several vertical stripes. Each stripe represents the amount of time defined by the "time base" constant.

The "time base" constant sets the resolution of the logic signals and, after being set by the user, may be modified as often as desired. The "time base" is inversely proportional to the resolution of the signals; thus, the lower the "time base" the greater the signal resolution and vice versa.

2. Cycles window

This window shows several vertical lines "|". Each one indicates the instant when the execution of a new cycle of the PLC program starts.

It permits maintaining a relationship between the flux of the logic signals and the duration of each PLC execution cycle.

3. Information window

This window provides general information about the trace being shown at the time. It shows the following data:

- The "Trigger" shows the trigger condition defined by the user to draw the trace.
- The "time base" indicates the time base defined by the user and used to show the current trace.
- The "Trace status" indicates the current status of the trace. The texts shown and their meanings are:

Empty	There is no calculated trace.
Capturing	There is a trace in progress.
Complete	There is a trace stored.

- The "cursor offset" indicates the distance from the cursor, vertical green line, to the trigger position, vertical red line. It is given in milliseconds.
- The "trigger type" indicates the type of trigger currently selected. The texts shown and their meanings are:

Before	The trigger is positioned at the beginning of the trace.
After	The trigger is positioned at the end of the trace.
Center	The trigger is positioned in the middle of the trace.
Default	When no trigger condition has been specified.

4. Editing window.

It is the CNC's standard editing window. It is used for all the processes that require data entry.

5. Message window.

This CNC uses this window to show a warning or error message.

10.

PLC
Logic analyzer



CNC 8055
CNC 8055i

·T· MODEL
SOFT: V01.3x

10.10.2 Selection of variables and trigger conditions

Before requesting a trace, one must define the variables to be analyzed, the trigger type and conditions and the time base to be used to show the captured values.

To do so, the following softkey options are available: "VARIABLE SELECTION", "TRIGGER CONDITION" and "TIME BASE".

Select variables

This option may be used to select up to 8 variables that will be analyzed later on.

It shows a cursor on the variables area that may be moved using the [↑][↓] keys. Also, the softkeys will show the following options:

"EDIT" softkey

This option may be used to edit a new variable or modify one of the currently defined variables.

Before pressing this softkey, use the cursor to select location to display that variable.

Once this option has been selected, the softkeys will change colors and they will appear over white background showing the information corresponding to the type of editing possible at that point.

Any logic signal of the PLC (I3, B1R120, TEN 3, CDW 4, DFU M200, etc.) may be analyzed and may be referred to by its name or its associated symbol. It is even possible to analyze logic expressions, consisting of one or several consultations that must follow the syntax and rules used in PLC equations.

M100 AND (NOT I15 OR I5) AND CPS C1 EQ 100

Although it is hard to understand the treatment of consultations and expressions in a logic analyzer, it must be borne in mind that this utility may be very interesting to know the status of a complete expression.

No more than 16 flank detecting instructions (DFU and DFD) can be used between all the definitions of variables and the selected trigger condition.

Pressing the [ESC] key deletes the variable being edited. From this point on, the variable may be edited again. Once the variable has been edited, press [ENTER]. The new edited variable will be shown in the location occupied by the cursor in the variables area.

It shows the first 8 characters of the selected variable, although the variable or expression used to define that variable has more characters.

The cursor will occupy the position of the next variable and it will show it in the editing area, thus being possible to continue editing new variables..

The editing area must be empty in order to quit this option. If it's not, press [ESC] to delete that information and then press [ESC] again.

"DELETE" softkey

This option may be used to delete a variable.

Before pressing this softkey, select with the cursor the variable to be deleted.

Repeat these steps for each variable to delete more variables.

"CLEAR ALL" softkey

This option deletes all the variables from the status window.

Selection of trigger condition

The trigger condition is defined as the condition used to capture the data. Also, the capture may be done before, after or before and after meeting the selected trigger condition.

This option may be used to select the trigger type and condition of the logic analyzer. To do this, the softkeys will show the following options:

10.

PLC
Logic analyzer

FAGOR 

CNC 8055
CNC 8055i

.T- MODEL
SOFT: V01.3x

10.

PLC
Logic analyzer**"EDIT" softkey**

It may be used to edit or modify the trigger condition to capture the data to be analyzed.

Once this option has been selected, the softkeys will change colors and they will appear over white background showing the information corresponding to the type of editing possible at that point.

It is possible to define any logic expression and it may consist of one or several consultations that must follow the syntax and rules used in PLC equations.

Example of expressions and trigger instant:

M100	The trigger occurs when M100 = 1.
NOT M100	The trigger occurs when M100 = 0.
CPS R100 EQ 1	The trigger occurs when R100 = 1.
NOT I20 AND I5	The trigger occurs when this expression is true.

No more than 16 flank detecting instructions (DFU and DFD) can be used between all the definitions of variables and the selected trigger condition.

Pressing the [ESC] key deletes the trigger condition being edited. From this point on, the condition may be edited again.

Once the trigger has been edited, press [ENTER]. The new edited condition will be shown in the information window.

If no trigger condition has been specified, the system considers that it is a default trigger and it will show the message "Trigger type": DEFAULT" in the information window. On the other hand, it is not be possible to select any of the possible trigger conditions (trigger before, trigger center, trigger after).

"TRIGGER BEFORE" softkey

The CNC starts capturing data from the moment when the selected trigger condition is met.

Then, once the trace has been executed, the trigger (vertical red line) will be shown at the beginning of the trace.

"TRIGGER AFTER" softkey

The CNC starts capturing data from the moment when the option to execute the trace is selected.

The trace will be completed when the selected trigger condition is met.

The system will show the trigger (vertical red line) at the end of the trace.

"TRIGGER CENTER" softkey

The CNC starts capturing data from the moment when the option to execute the trace is selected.

Then, once the trace has been executed, the trigger (vertical red line) will be shown in the middle of the trace.

Selection of the time base

The operator may use this parameter to assign the timeframe to each vertical division.

The size of these divisions, therefore the resolution of these signals will be determined by this time base. Consequently, the smaller the time base, the greater the signal resolution.

Example:

There is a mark that changes states every 2 milliseconds.

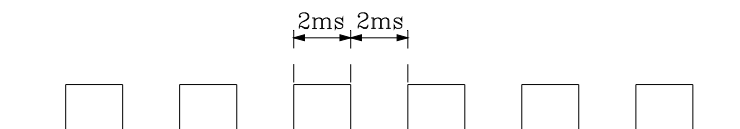

Using a 10 millisecond time base, it will look like this:

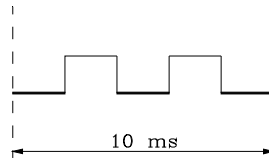

Using a 20 millisecond time base, it will look like this:

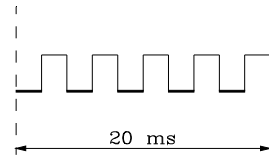

Using a 4 millisecond time base, it will look like this:

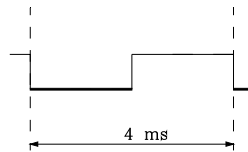

The time base is defined in milliseconds and the selected value will be shown in the information window. By default, the CNC assumes a time base of 10 milliseconds.

At first, a time base may be defined that will match the frequency of the signals to be treated. Then, when analyzing the trace, that base time may be modified to obtain a higher resolution of the signals.

10.10.3 Execute trace

Once the desired variables and trigger conditions have been selected, press the "EXECUTE TRACE" softkey so the CNC starts capturing data.

When the selected trigger condition is met, the trigger line shown in the information window changes colors.

While the trace is being executed, the information window shows the text "Trace status: CAPTURING".

The trace will end when the internal memory buffer dedicated to it is full or if it is interrupted by pressing the "STOP TRACE" softkey. While the trace is being executed, the information window shows the text "Trace status: COMPLETE".

Data capture

The data capture takes place at the beginning of each cycle (PRG and PE) after reading the physical inputs and updating the marks corresponding to the CNC logic outputs and just before starting the program execution.

Use this instruction to carry out another data capture while executing the PLC cycle.

With this instruction, it is possible to capture the data of the signals that vary with frequencies higher than the cycle time and data of signals whose status changes while executing the cycle, but have the same status at the beginning and at the end of the cycle.

Example of how to use the "TRACE" instruction:

```

PRG
-----
TRACE      Data capture
-----
TRACE      Data capture
-----
TRACE      Data capture
-----
END
PE 5
-----
TRACE      Data capture
-----
END

```

The data capture in the execution of the trace in this program takes place:

- At the beginning of each PRG cycle.
- Every time the periodic cycle is executed (every 5 milliseconds).
- 3 times while executing the PRG module.
- Once while executing the PE module.

This way, by means of the "TRACE" instruction the data capture can be done any time, especially at those program points considered more critical.

This instruction must only be used when debugging the PLC program and it should be avoided once the PLC program is fully debugged.

Operating modes

The way the data is captured depends on the type of trigger that has been selected. Here are the various types of trigger used and how the data is captured in each case:

10.

PLC
Logic analyzer



CNC 8055
CNC 8055i

-T- MODEL
SOFT: V01.3X

Trigger before

The data capture begins when the selected trigger condition is met, i.e. when the trigger line shown in the information window changes colors.

The trace will end when the internal memory buffer of the trace is full or when forces a trace stop ("STOP TRACE" softkey).

If the trace stop ("STOP TRACE" softkey) is forced before the trigger takes place, the trace will be empty.

Trigger after

The data capture starts when the "EXECUTE TRACE" softkey is pressed.

The trace will end when the selected trigger condition is met or when forces a trace stop ("STOP TRACE" softkey).

If the trace stop is forced before the trigger takes place, it will show a trace with data, but without the trigger position (vertical red line).

Trigger center

The data capture starts when the "EXECUTE TRACE" softkey is pressed.

The CNC will enable half the trace buffer to store the data for trace before the trigger and the other half for the data after the trigger.

The trace will end when the internal memory buffer of the trace is full or when forces a trace stop ("STOP TRACE" softkey).

If the trace stop is forced before the trigger takes place, it will show a trace with data, but without the trigger position (vertical red line).

Default trigger

The CNC makes this type of trace when no trigger condition has been specified.

The data capture starts when the "EXECUTE TRACE" softkey is pressed.

The trace concludes when the trace stop is forced before ("STOP TRACE" softkey) and it will show a trace with data, but without the trigger position (vertical red line).

Trace representation

Once the data capture is done, the CNC will display graphically in the status window the status of the signals based on the trace calculated for the analyzed variables.

Also, a vertical red line indicating the trigger position and a vertical green line indicating the cursor position will appear superimposed on the trace.

The cursor position (vertical green line) can be slid along the trace by means of the following keys:

Left arrow

Shifts the cursor a pixel to the left. While keeping this key pressed, the cursor will advance automatically one pixel at a time and increasing its speed.

If the cursor is positioned at the left end, the trace will be shifted to the right while the cursor stays in the same position.

Right arrow

Shifts the cursor a pixel to the right. While keeping this key pressed, the cursor will advance automatically one pixel at a time and increasing its speed.

If the cursor is positioned at the right end, the trace will be shifted to the left while the cursor stays in the same position.

Previous page

Shifts the cursor a screen to the left.

10.PLC
Logic analyzer**FAGOR** **CNC 8055**
CNC 8055i·T· MODEL
SOFT: V01.3x

Next page

Shifts the cursor a screen to the right.

The information window of the CNC shows the position of the cursor, vertical green line, with respect to the trigger position, vertical red line. That information is shown as "cursor offset:" and it is given in milliseconds.

Analyze trace

Once the data capture is done, the CNC, besides showing the trace in the status window, enables the "ANALYZE TRACE" softkey.

This option may be used to position the cursor (vertical green line) at the beginning of the trace, at the end or at a particular point of the trace. Likewise, it may be used to change the time base used to draw the trace or calculate the time between two points of the trace.

To do so, the following softkey options are available:

Find beginning

It will show the beginning of the trace with the cursor positioned at the beginning of the trace.

Find end

It will show the last portion of the trace with the cursor positioned at the end of the trace.

Find trigger

It will show the trace area corresponding to the trigger area. The position where the trigger took place will be shown with a vertical red line superimposed on the trace.

The CNC will execute this option when the trigger occurs while analyzing the trace.

Find time base

When pressing this softkey, the CNC will request the desired cursor position with respect to the trigger point. This value is given in milliseconds.

For example: If a "Time search" of -1000 milliseconds has been selected, the CNC will show the portion of the trace for 1 second prior to the trigger instant.

If no trigger has occurred while analyzing the trace, the CNC will assume that the indicated position is referred to the beginning of the trace.

Calculate times

This option may be used to calculate the time between two points of the trace; follow these steps to define the starting and last points of the calculation.

Place the cursor at the first point of the calculation press the "MARK BEGINNING" softkey to validate it. The cursor is moved using the [▲] [▼] keys, "previous page" and "next page".

Place the cursor at the last point of the calculation press the "MARK END" softkey to validate it.

The message window of the CNC will show the amount of time between them. This time is given in milliseconds.

This feature may be very useful to calculate precisely flank times of a signal, time between the trigger of two signals, time between the trigger of a signal and the beginning of the cycle, etc.

Modify base

With this option it is possible to modify the "time base".

The status area is divided into several vertical stripes. Each stripe represents the amount of time defined by the "time base" constant.

The "time base" is inversely proportional to the resolution of the signals; thus, the lower the "time base" the greater the signal resolution and vice versa.

10.

PLC
Logic analyzer



CNC 8055
CNC 8055i

.T. MODEL
SOFT: V01.3X

Pressing this softkey, the CNC will request the new value to be assigned to the time base. This value is given in milliseconds.

10.

PLC
Logic analyzer

FAGOR 

CNC 8055
CNC 8055i

.T. MODEL
SOFT: V01.3x

10.

PLC

Logic analyzer



**CNC 8055
CNC 8055i**

.T. MODEL
SOFT: V01.3x

In this operating mode, the operator can create up to 256 PAGES (screens) which will be stored in the hard disk (KeyCF).

The operator can also create up to 256 SYMBOLS to be used when creating the user screens. These symbols are also saved in the hard disk (KeyCF).

The information contained in a page or symbol cannot occupy more than 4Kb of memory. Otherwise, the CNC will issue the corresponding error message.

The user screens stored in the hard disk (KeyCF) may be:

- Used in the screen customizing programs as described next.
- Displayed on power-up (page 0) instead of the FAGOR logo.
- Activated from the PLC.

The PLC has 256 marks, with their corresponding mnemonics, to select the user screens. These marks are:

M4700	PIC0
M4701	PIC1
M4702	PIC2
---	----
---	----
M4953	PIC253
M4954	PIC254
M4955	PIC255

When any of these marks is set high, its corresponding screen (page) is activated.

- Used to complete the M function assistance system (screens 250-255).

When requesting programming assistance for the auxiliary M functions by pressing the [HELP] key, the CNC will show the corresponding internal screen (page).

When user page 250 is defined, that information will also include the symbol(a) indicating that more help pages are available. By pressing this key, the CNC will display user screen 250.

The CNC will keep showing that indicator as long as there are more user screens defined (250-255).

These screens must be defined in a row always starting from page 250. If one of them is missing, the CNC will interpret that there are no more screens defined.



CNC 8055
CNC 8055i

.T. MODEL
SOFT: V01.3x

The user screens activated from the PLC may be displayed with the ACTIVE PAGES option of the PLC.

The various options available in this operating mode are:

UTILITIES

To manipulate user symbols and screens (edit, copy, delete, etc.).

GRAPHIC ELEMENTS

To insert graphic elements in the selected symbol or screen.

TEXTS

To insert texts in the selected symbol or screen.

MODIFICATIONS

To modify the selected symbol or screen.

11.**SCREEN EDITOR**

**CNC 8055
CNC 8055i**

.T. MODEL
SOFT: V01.3x

11.1 Utilities

The various options available in this mode are:

"DIRECTORY" softkey

To display the directory of user screens and symbols that are stored in the hard disk (KeyCF) or in an external device through the serial line.

Select the desired device and directory.

The CNC shows the size (in bytes) of each user screen (page) and symbol.

"COPY" softkey

To make copies within the hard disk (KeyCF) or between the hard disk (KeyCF) and an external device.

Examples:

- To copy screen (page) 5 from the hard disk (KeyCF) to serial line.

```
COPY      PAGE      5      IN      L SERIE (DNC)
```

- To copy screen (page) 50 from the serial line to the hard disk (KeyCF).

```
COPY      L SERIE (DNC)      IN      PAGE      50      ENTER
```

- To copy symbol 15 as symbol 16 within the hard disk (KeyCF).

```
COPY      SYMBOL      15      IN      SYMBOL      16      ENTER
```

"DELETE" softkey

To delete a screen or symbol from the hard disk (KeyCF); to do that, proceed as follows:

- Press the [DELETE] softkey
- Press the [PAGE] or [SYMBOL] softkey
- Key in the page or screen number to be deleted and press [ENTER]

The CNC will request confirmation of the command.

"RENAME" softkey

To assign a new name or comment to a page or symbol of the hard disk (KeyCF).

If there is another one with the same number, the CNC will display a warning message and it will offer the chance to modify the command.

Examples:

- To change the page number from 20 to 55.

```
RENAME      PAGE      20      A      NEW NUMBER      55      ENTER
```

- To change the comment of symbol 10.

```
RENAME      SYMBOL      10      A      NEW NUMBER      "Hello"      ENTER
```

"EDIT" softkey

To edit a new user screen (page) or symbol. To do this:

11.

SCREEN EDITOR
Utilities

FAGOR 

CNC 8055
CNC 8055i

.T. MODEL
SOFT: V01.3x

- Press the [EDIT] softkey.
- Press the [PAGE] or [SYMBOL] softkey
- Key in the page or symbol number.
- Press [ENTER].

If the page or symbol does not exist, an empty page will appear in the editing area.

How to edit user screens and symbols is described later on in this chapter.

If the selected screen or symbol has been changed, the CNC will request whether it is to be saved or not in the following instances:

- When exiting the SCREEN EDITOR mode.
- When selecting another screen (page) or symbol.

"SAVE" softkey

To save the page or symbol being edited into the hard disk (KeyCF).

11.

SCREEN EDITOR Utilities



CNC 8055
CNC 8055i

-T- MODEL
SOFT: V01.3x

11.2 Editing user screens (pages) and symbols

In order to edit a page or symbol, it is necessary to selected first by means of the EDIT option of the UTILITIES mode of operation.

To edit or modify a page or symbol, use the options: GRAPHIC ELEMENTS, TEXTS, and MODIFICATIONS.

The information contained in a page or symbol cannot occupy more than 4Kb of memory. Otherwise, the CNC will issue the corresponding error message.

Once the page or symbol has been selected, the CNC will display a screen similar to this one:

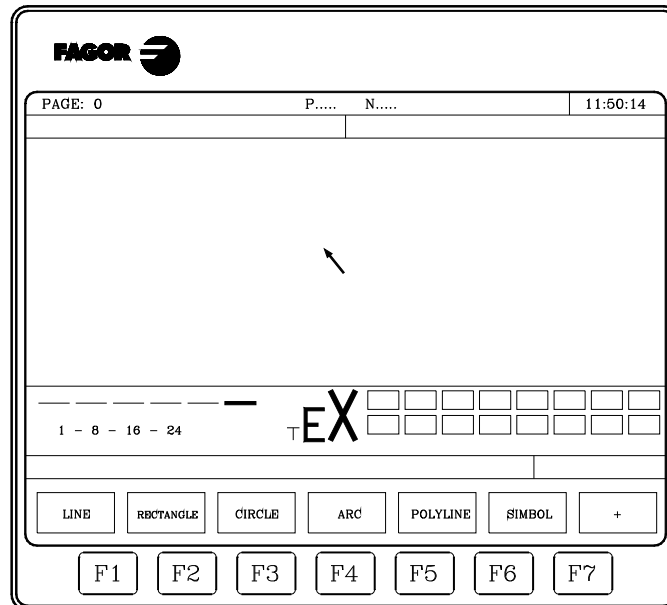

The upper left-hand side of the screen will show the number of the page or symbol being edited.

The main window shows the selected page or symbol. When it is a new page or symbol, the main window will display a blank page or empty symbol.

There is also a window at the bottom of the screen which shows the different editing parameters and highlights their selected values. The various parameters available are:

- The type of drawing line used when defining the graphic elements.
- The cursor moving steps (cursor advance) in pixels.
- The letter size to create the texts for the pages and symbols.
- The background and foreground (main) colors for the graphic elements and for the letters.

One of the color rectangles shown has another rectangle in it. The inside rectangle indicates the selected main color and the outside rectangle indicates the selected background color.

This window also shows the cursor position coordinates in pixels. The horizontal position is indicated by the X value (1 through 638) and the vertical position by the Y value (0 through 334).

Once one of the options (GRAPHIC ELEMENTS, TEXTS or MODIFICATIONS) has been selected, it will be possible to modify the editing parameters any time even while defining the graphic elements and texts.

This way, it is possible to edit shapes of different lines and color as well as insert texts of different sizes. Press [INS] to access this menu.

Once in this mode, the CNC will show the softkeys corresponding to the various options to modify these parameters. These options are described next. Press [INS] again to quit this mode and return to the previous menu.

"CURSOR ADVANCE" softkey

With this option it is possible to select the cursor moving step in pixels (1, 8, 16, 24). Follow these steps after pressing this softkey:

11.

SCREEN EDITOR
Editing user screens (pages) and symbols

FAGOR 

CNC 8055
CNC 8055i

.T. MODEL
SOFT: V01.3x

1. Use the [←] [→] keys to select the desired step.
The currently selected step will be highlighted.
2. Press [ENTER] to validate the selected step or [ESC] to quit this mode leaving the previous selection intact.

When editing a new page or symbol, the CNC assumes the default value of 8.

"TYPE OF LINE" softkey

With this option it is possible to select the type of line used to define the graphic elements. Follow these steps after pressing this softkey:

1. Use the [←] [→] keys to select the desired type of line.
The currently selected line type will be highlighted.
2. Press [ENTER] to validate the selected step or [ESC] to quit this mode leaving the previous selection intact.

When editing a new page or symbol, the CNC assigns to this parameter the "fine solid line".

It is not possible to use the thick line to draw polylines or polygons. They are always drawn in fine line.

"TEXT SIZE" softkey

With this option it is possible to select the size of the letters used to write the texts to be inserted in the pages or symbols. Three text sizes are available:

- Normal size
All the characters of the keyboard, numbers, signs, upper and lower case letters, can be written in this size.
- Double and triple sizes.
In these sizes, it is possible to show upper case letters "A ... Z", numbers "0 ... 9"; the "*", "+", "-", ".", ":", "#", "%", "/", "<", ">", "?" signs and the special characters: "Ç", "Ä", "Ö", "Ü", "ß" can be written in these sizes.
When selecting lower case letters for these sizes, the CNC will convert them automatically into upper case.

Follow these steps to select a text size:

1. Use the [↑] [↓] keys to select the desired text size.
The currently selected text size will be highlighted.
2. Press [ENTER] to validate the selected text size or [ESC] to quit this mode leaving the previous selection intact.

When editing a new page or symbol, the CNC assumes the normal size by default.

"BACKGROUND COLOR" softkey

With this option it is possible to select the background color of the graphic screen.

It is not possible to change the background color when editing a symbol since it is an attribute of the page and not of the symbol

If the desired background color is white, it is recommended to use a different color while creating the page since the cursor the "drawing" cursor is always white and will become invisible with this background color. Once the complete page (screen) is created, the background color can be changed to the desired one.

One of the color rectangles shown has another rectangle in it. The inside rectangle indicates the selected main color and the outside rectangle indicates the selected background color.

To select the background color, proceed as follows:

11.

1. Use the [←] [→] [↑] [↓] keys to select the desired background color among the 16 shown on the screen.

The CNC will show with the inside rectangle the currently selected background color.

2. Press [ENTER] to validate the selected color or [ESC] to quit this mode leaving the previous selection intact.

When editing a new page or symbol, the CNC assumes a blue background color by default.

"MAIN COLOR" softkey

With this option it is possible to select the color used to draw and write texts on the page (screen) or symbol.

One of the color rectangles shown has another rectangle in it. The inside rectangle indicates the selected main color and the outside rectangle indicates the selected background color.

To select the main color, follow these steps:

1. Use the [←] [→] [↑] [↓] keys to select the desired main color among the 16 shown on the screen.
The CNC will show the main color being selected by placing a white inside rectangle. It will also display the rectangle containing both the selected background color and the main color being selected here.
2. Press [ENTER] to validate the selected color or [ESC] to quit this mode leaving the previous selection intact.

When editing a new page or symbol, the CNC assumes white as the main color by default.

"GRID" softkey

This option displays a grid of points with a 16-pixel pitch on the screen.

The grid points will be white when the selected background color corresponds to one of the 8 upper color rectangles and they will be black when the selected background color corresponds to one of the 8 lower color rectangles.

Press this softkey again to get rid of the grid.

Every time the grid is displayed, the CNC will reset the cursor step to 16 pixels.

Since this value coincides with the distance between grid points, the cursor will move from point to point on grid. However, the cursor advance may be modified afterwards by selecting it with the CURSOR ADVANCE softkey.

11.3 Graphic elements

Before accessing this option, it is necessary to select the page or symbol to be edited or modified by means of the EDIT option of the UTILITIES mode of operation.

With this option it is possible to include graphic elements in the selected page or symbol. The CNC displays a screen 80 columns wide (640 pixels for X coordinate) by 21 rows high (336 pixels for Y coordinate).

When editing a new page, the CNC will position the cursor in the center of the screen and when editing a new symbol, it will position it at the upper left-hand corner.

The cursor is white and once one of the possible graphic elements has been selected, it can be moved around on the screen with the [←] [→] [↑] [↓] keys.

The cursor can also be moved by using the following keystroke combinations:

[SHIFT] + [→]	Positions the cursor at the last column (X638).
[SHIFT] + [←]	Positions the cursor at the first column (X1).
[SHIFT] + [↑]	Positions the cursor at the first row (Y0).
[SHIFT] + [↓]	Positions the cursor at the last row (Y334).

It is also possible to key in the XY coordinates of the point where the cursor is to be positioned. To do this, follow these steps:

1. Press "X" or "Y".

The CNC will highlight, in the editing parameter display window, the cursor position along the selected axis.

2. Key in the position value corresponding to the point where the cursor is to be placed along this axis.

The horizontal position is defined as the X value between 1 and 638 and the vertical position as the Y value between 0 and 334.

Once the desired text has been selected, press [ENTER]. The CNC will move the cursor to the indicated position.

Once this option is selected, it is possible to modify the editing parameters at any time even while defining the graphic elements. This way, it is possible to edit shapes of different line and color. Press [INS] to access this menu.

Once in this mode, press the corresponding softkey to modify those parameters. Press [INS] again to quit this mode and return to the previous menu.

The possible graphic elements which can be used to create a page or symbol are selected with the softkeys and are the following:

"LINE" softkey

Follow these steps after pressing this softkey:

1. Place the cursor at the beginning of the line and press [ENTER] to validate it.
2. Move the cursor to the end of the line (the CNC will continuously show the line being drawn).
3. Press [ENTER] to validate the line or [ESC] to cancel it.

Repeat the preceding steps to draw more lines. If no more lines are desired, press [ESC] to return to the previous menu.

11.

SCREEN EDITOR
Graphic elements



CNC 8055
CNC 8055i

-T- MODEL
SOFT: V01.3x

"RECTANGLE" softkey

Follow these steps after pressing this softkey:

1. Place the cursor on one of the corners of the rectangle and press [ENTER] to validate it.
2. Move the cursor to the opposite corner; the CNC will continuously show the rectangle being drawn.
3. Press [ENTER] to validate the rectangle or [ESC] to cancel it.

Repeat these steps to draw more rectangles. If no more rectangles are desired, press [ESC] to return to the previous menu.

"CIRCLE" softkey

Follow these steps after pressing this softkey:

1. Place the cursor at the center of the circle and press [ENTER] to validate it.
2. Move the cursor in order to define the radius. As the cursor moves, the CNC will show the circle corresponding to that radius.
3. Press [ENTER] to validate the circle or [ESC] to cancel it.

Once the circle is validated, the cursor is positioned at its center in order to facilitate the drawing of concentric circles.

Repeat these steps to draw more circles. If no more circles are desired, press [ESC] to return to the previous menu.

"ARC" softkey

Follow these steps after pressing this softkey:

1. Place the cursor at one of the arc's ends and press [ENTER] to validate it.
2. Move the cursor to the other end of the arc (the CNC will show a line joining both ends) and press [ENTER] to validate it.

Once both ends of the arc have been validated, the cursor is positioned in the center of the straight line that joins them.

3. Move the cursor to define the curvature. The line will become an arc passing through 3 points (the two ends and the cursor point).
4. Press [ENTER] to validate the arc or [ESC] to cancel it.

Repeat these steps to draw more arcs. If no more arcs are desired, press [ESC] to return to the previous menu.

"POLYLINE" softkey

A polyline consists of several lines where the last point of one of them is the beginning point for the next one.

Follow these steps after pressing this softkey:

1. Place the cursor at one of the ends of the polyline and press [ENTER] to validate it.
2. Move the cursor to the end of the first line (which will be the beginning of the next one). The CNC will continuously show the line being drawn.

Press [ENTER] to validate the line or [ESC] to quit this option (which will delete the complete polyline).

3. Repeat step 2 for the remaining lines.

Note that the maximum number of straight lines in a polyline is 127.

Once the polyline is drawn, press [ENTER] again to validate it or [ESC] to quit this option deleting the complete polyline.

11.

SCREEN EDITOR
Graphic elements

FAGOR 

CNC 8055
CNC 8055i

-T- MODEL
SOFT: V01.3x

Repeat these steps to draw more polylines and if no more polylines are desired, press [ESC] to return to the previous menu.

"SYMBOL" softkey

This option allows a symbol to be drawn in the page or symbol being edited.

Follow these steps to insert a symbol in the desired place:

1. Enter the number of the symbol to include in the page or symbol being edited and press the [ENTER] key to validate it.
The CNC will show that symbol. The cursor will be at the reference point corresponding to the symbol (upper left hand corner of the symbol).
2. Move the cursor to the position where it is required to place the symbol. In this move, only the cursor will move and not the symbol.
3. Once the cursor has been placed in the desired position, press [ENTER] for the CNC to insert the symbol in that position.
If no more symbols are to be inserted, press [ESC] to quit this option.
4. The selected symbol may be inserted in several places. To do that, move the cursor again and press [ENTER] for the CNC to insert the symbol in that position.
5. Press the [ESC] key to quit and go back to the previous menu.

To insert several different symbols in the currently selected page or symbol, the "SYMBOL" option must be selected every time a new symbol is to be inserted.

A symbol cannot be included into itself. Therefore, if symbol 4 is being edited, any symbol can be included except symbol 4.



If a symbol is deleted, the CNC will update all the pages or symbols that contain it because all the calls to it will remain active.

When displaying a page or symbol that has a call to a nonexistent symbol (deleted or not defined), that area of the page will appear blank.

If this symbol is edited again later, the new representation assigned to the symbol will appear in all the pages and symbols which contain a call to it.

"POLYGON" softkey

A polygon is a closed polyline whose beginning and end points coincide.

To draw a polygon, proceed as follows:

1. Place the cursor on one of the vertices of the polygon and press the [ENTER] key to validate it.
2. Move the cursor to the following vertex of the polygon (the CNC will show the line you are trying to draw).
Press [ENTER] to validate the line or [ESC] to quit this option (which will delete the complete polyline).
3. Repeat step 2 for the remaining vertices.

After defining all the vertices, press [ENTER] again. The CNC will complete the polygon and will show the line joining the first and last vertices.

Repeat these steps to draw more polygons and if no more polygons are desired, press [ESC] to return to the previous menu.

"FILLED POLYGON" softkey

To draw a filled polygon, follow the steps indicated in the "POLYGON" option.

Once the polygon has been defined, the CNC will fill it with the color used to define it.

11.

SCREEN EDITOR
Graphic elements



CNC 8055
CNC 8055i

.T. MODEL
SOFT: V01.3X

"FILLED CIRCLE" softkey

To draw a filled circle, follow the steps indicated in the "CIRCLE" option.

Once the circle has been defined, the CNC will fill it with the color used to define it.

"FILLED RECTANGLE" softkey

To draw a filled polygon, follow the steps indicated in the "RECTANGLE" option.

Once the rectangle has been defined, the CNC will fill it with the color used to define it.

11.

SCREEN EDITOR
Graphic elements

FAGOR 

**CNC 8055
CNC 8055i**

-T- MODEL
SOFT: V01.3X

11.4 Texts

Before accessing this option, it is necessary to select the page or symbol to be edited or modified by means of the EDIT option of the UTILITIES mode of operation.

With this option it is possible to include texts in the selected page or symbol. The CNC displays a screen 80 columns wide (640 pixels for X coordinate) by 21 rows high (336 pixels for Y coordinate).

When editing a new page, the CNC will position the cursor in the center of the screen and when editing a new symbol, it will position it at the upper left-hand corner.

The cursor is white and once the text to be inserted has been selected, it can be moved around on the screen with the [←] [→] [↑] [↓] keys.

The cursor can also be moved by using the following keystroke combinations:

[SHIFT] + [→]	Positions the cursor at the last column (X638).
[SHIFT] + [←]	Positions the cursor at the first column (X1).
[SHIFT] + [↑]	Positions the cursor at the first row (Y0).
[SHIFT] + [↓]	Positions the cursor at the last row (Y334).

It is also possible to key in the XY coordinates of the point where the cursor is to be positioned. To do this, follow these steps:

1. Press "X" or "Y".

The CNC will highlight, in the editing parameter display window, the cursor position along the selected axis.

2. Key in the position value corresponding to the point where the cursor is to be placed along this axis.

The horizontal position is defined as the X value between 1 and 638 and the vertical position as the Y value between 0 and 334.

Once the desired text has been selected, press [ENTER]. The CNC will move the cursor to the indicated position.

Once this option is selected, it is possible to modify the editing parameters at any time even while defining the texts. This way, it is possible to edit texts of different size and color. Press [INS] to access this menu.

Once in this mode, press the corresponding softkey to modify those parameters. Press [INS] again to quit this mode and return to the previous menu.

It is also possible to insert one of the texts available at the CNC or a text previously keyed in by the user. To do this, the following softkey options are available:

USER DEFINED TEXT

Follow these steps to insert the desired text:

1. Press the [ENTER] key.

The CNC will display a text editing window; the cursor within this window can be moved with the [←] [→] keys.

2. Type the desired text.

A rectangle will be displayed which will enlarge as the text is "typed" in the editing window thus indicating the screen space that this text will occupy.

Press [ESC] to cancel this option and the previous menu will be displayed.

3. Press [ENTER] once the text has been correctly "typed in".

The typed text will remain in the editing window and the cursor will be positioned in the main window.

4. Position the rectangle by moving the cursor.

5. Press [ENTER] to validate the command. The CNC will replace the rectangle with the indicated text.

Note that once the text has been "entered", neither its size nor its color can be modified. Therefore, these options must be selected before pressing [ENTER].

11.

SCREEN EDITOR
Texts



CNC 8055
CNC 8055i

-T- MODEL
SOFT: V01.3X

TEXT NUMBER

With this option it is possible to select a text used by the CNC itself in its various operating modes and insert it into the current page or symbol.

To insert one of these predetermined texts, follow these steps:

1. Press the relevant softkey.

The CNC will display an area to define the text number; the cursor within this area can be moved with the [←] [→] keys.

2. Indicate the desired number by keying it in from the keyboard and press [ENTER].

The CNC will show the text that has been selected. The CNC will display in its main window a rectangle indicating the size of the text.

If another text is desired, key in the other number and press [ENTER] again.

Press [ESC] to cancel this option and the previous menu will be displayed.

3. Once the desired text has been selected, press [ENTER].

The typed text will remain in the editing window and the cursor will be positioned in the main window.

4. Position the rectangle by moving the cursor.

5. Press [ENTER] to validate the command. The CNC will replace the rectangle with the indicated text.

Note that once the text has been "entered", neither its size nor its color can be modified. Therefore, these options must be selected before pressing [ENTER].



This application may be useful when the pages or symbols being edited are to be shown in other languages since the CNC will translate them into the chosen language.

Usually, when the texts are to be shown in one single language, it is more practical to simply write them up instead of searching them in a list of more than 1500 predetermined messages.

However, should anyone desire the printout of these predetermined texts, feel free to request it from Fagor Automation.

11.

SCREEN EDITOR
Texts

FAGOR 

CNC 8055
CNC 8055i

-T- MODEL
SOFT: V01.3x

11.5 Modifications

Before accessing this option, it is necessary to select the page or symbol to be edited or modified by means of the EDIT option of the UTILITIES mode of operation.

The cursor is white and once one of the modifying options has been selected, it can be moved around on the screen with the [←] [→] [↑] [↓] keys.

The cursor can also be moved by using the following keystroke combinations:

[SHIFT] + [→]	Positions the cursor at the last column (X638).
[SHIFT] + [←]	Positions the cursor at the first column (X1).
[SHIFT] + [↑]	Positions the cursor at the first row (Y0).
[SHIFT] + [↓]	Positions the cursor at the last row (Y334).

It is also possible to key in the XY coordinates of the point where the cursor is to be positioned. To do this, follow these steps:

1. Press "X" or "Y".

The CNC will highlight, in the editing parameter display window, the cursor position along the selected axis.

2. Key in the position value corresponding to the point where the cursor is to be placed along this axis.

The horizontal position is defined as the X value between 1 and 638 and the vertical position as the Y value between 0 and 334.

Once the desired text has been selected, press [ENTER]. The CNC will move the cursor to the indicated position.

The possible options to modify a page or symbol are:

CLEAR PAGE

Allows the selected page or symbol to be deleted.

Once this softkey has been pressed, the CNC will request an OK before executing the indicated operation.

Executing this option clears the page or symbol being edited. However, the CNC will keep in the hard disk (KeyCF) the contents of that page or symbol the last time the "SAVE" command was executed.

DELETE ELEMENTS

This option allows an element of the displayed page or symbol to be selected and then deleted.

Follow these steps to delete a text or any graphic element displayed on the selected screen or symbol:

1. Place the cursor on the element to be deleted and press the [ENTER] key.

An area of between ± 8 pixels from the position indicated will be analyzed.

If it is a symbol, place the cursor on the cross that indicates the reference point of that symbol.

If the element to be deleted is a filled circle or a filled polygon, the cursor must be positioned on a point on the circumference or outside polygon.

2. If any graphic element or text exists in this area, this will be highlighted and you will be asked if you wish to delete it.

Press [ENTER] to delete that element, or [ESC] if otherwise.

Should there be several elements in this area, the CNC will highlight them in succession and it will ask for confirmation before deleting any of them.

11.

SCREEN EDITOR
Modifications



CNC 8055
CNC 8055i

-T- MODEL
SOFT: V01.3X

MOVE SCREEN

With this option, it is possible to move a whole set of graphic elements and texts of the currently selected screen. This option is not available when a symbol is selected.

When selecting this option, the CNC places the cursor in the middle of the screen and assumes that point as the screen's reference point.

To move the screen, proceed as follows:

1. Move the cursor to the desired position for the page's reference point.
2. Press [ENTER] to validate the command. The CNC will move the whole set of graphic elements and texts of the currently selected screen.

Press [ESC] to cancel this option and the previous menu will be displayed.

Repeat the previous operations to move the screen somewhere else. If not, press [ESC] and the CNC will display the previous menu.

11.

SCREEN EDITOR
Modifications

FAGOR 

CNC 8055
CNC 8055i

-T- MODEL
SOFT: V01.3x

11.

SCREEN EDITOR Modifications



CNC 8055
CNC 8055i

-T- MODEL
SOFT: V01.3x

In order for the machine tool to be able to properly execute the programmed instructions, the CNC must know the specific data of the machine such as feedrate, acceleration, feedback, automatic tool change, etc.

This data is set by the machine manufacturer and must be stored in the machine parameter tables. These tables may be edited in this work mode or copied from the hard disk (KeyCF) or a PC as described later on. When accessing this operating mode, the CNC will show the tables that are saved in the hard disk (KeyCF).

The CNC has the following groups of machine parameters:

- General machine parameters.
- Machine parameters for the axes (one table per axis)
- Spindle parameters.
- Drive parameters.
- RS-232-C serial port configuration parameters.
- Ethernet configuration parameters.
- PLC Parameters.
- Auxiliary (miscellaneous) M functions.
- Leadscrew error compensation (one table per axis).
- Cross Compensations between two axes (e.g. ram sag).

First, the general machine parameters must be set since they determine the machine axes.

It must also be defined whether the machine has cross compensation and between which axes, and the CNC will generate the corresponding cross compensation parameters.

By means of the general machine parameters, the table lengths for the tool magazine, tools, tool offsets and the miscellaneous M functions are defined.

Use the axis parameters to determine whether leadscrew error compensation will be applied or not and define the length of the corresponding table.

Once the general machine parameters are defined, press [SHIFT]+[RESET] for the CNC to enable the required tables. We recommend to save the tables into the hard disk (KeyCF), a peripheral device or a PC.

12.1 Machine parameter table

The general, axis, spindle, serial ports and PLC parameter tables have the following structure:

GENERAL PARAMETERS		P.....	N.....	11:50:14
PARAMETER	VALUE	NAME		
P000	01	AXIS1		
P001	02	AXIS2		
P002	03	AXIS3		
P003	04	AXIS4		
P004	05	AXIS5		
P005	10	AXIS6		
P006	11	AXIS7		
P007	00	AXIS8		
P008	0	INCHES		
P009	0	MOVE		
P010	0	ICORNER		
P011	0	IPLANE		
P012	0	ILCOMP		
P013	0	ISYSTEM		
P014	0	IFEED		
P015	1	THEODPLY		
P016	000	GRAPHICS		
P017	YES	RAPIDOVR		
P018	120	MAXFOVR		
P019	00000	CIRINLIM		

CAP INS MM

EDIT MODIFY FIND INITIALIZE LOAD SAVE MM/INCH

F1 F2 F3 F4 F5 F6 F7

Each table shows the parameter number is indicated, the value assigned to it and the name or mnemonic associated with this parameter.

12.

MACHINE PARAMETERS
 Machine parameter table



CNC 8055
CNC 8055i

.T. MODEL
SOFT: V01.3x

12.3 Leadscrew error compensation tables

The tables for leadscrew error compensation have the following structure:

12.

MACHINE PARAMETERS
Leadscrew error compensation tables

X AXIS COMPENSATION		P.....	N.....	11:50:14	
POINT NUMBER		POSITION		ERROR	
P001	X	0.0000	EX	0.0000	
P002	X	0.0000	EX	0.0000	
P003	X	0.0000	EX	0.0000	
P004	X	0.0000	EX	0.0000	
P005	X	0.0000	EX	0.0000	
P006	X	0.0000	EX	0.0000	
P007	X	0.0000	EX	0.0000	
P008	X	0.0000	EX	0.0000	
P009	X	0.0000	EX	0.0000	
P010	X	0.0000	EX	0.0000	
P011	X	0.0000	EX	0.0000	
P012	X	0.0000	EX	0.0000	
P013	X	0.0000	EX	0.0000	
P014	X	0.0000	EX	0.0000	
P015	X	0.0000	EX	0.0000	
P016	X	0.0000	EX	0.0000	
P017	X	0.0000	EX	0.0000	
P018	X	0.0000	EX	0.0000	
P019	X	0.0000	EX	0.0000	
P020	X	0.0000	EX	0.0000	
X 00020.000					
				CAP INS MM	
EDIT	MODIFY	FIND	INITIALIZE	LOAD	SAVE
MM/INCH					
F1	F2	F3	F4	F5	F6
F7					

The number of points of each of these is defined by means of the axis machine parameter "NPOINTS". The following is defined for each of line:

- The position of the axis to be compensated.
- The amount of error of the axis in this point.

Also, the current position of the selected axis is displayed and updated as the machine axis moves. This position is updated as the axis moves.



CNC 8055
CNC 8055i

.T. MODEL
SOFT: V01.3x

12.4 Cross compensation table

The tables corresponding to cross compensation have the following structure.

CROSS COMP. TABLE		P.....	N.....	11:50:14		
POINT NUMBER	POSITION	ERROR				
P001	X	0.0000	EY	0.0000		
P002	X	0.0000	EY	0.0000		
P003	X	0.0000	EY	0.0000		
P004	X	0.0000	EY	0.0000		
P005	X	0.0000	EY	0.0000		
P006	X	0.0000	EY	0.0000		
P007	X	0.0000	EY	0.0000		
P008	X	0.0000	EY	0.0000		
P009	X	0.0000	EY	0.0000		
P010	X	0.0000	EY	0.0000		
P011	X	0.0000	EY	0.0000		
P012	X	0.0000	EY	0.0000		
P013	X	0.0000	EY	0.0000		
P014	X	0.0000	EY	0.0000		
P015	X	0.0000	EY	0.0000		
P016	X	0.0000	EY	0.0000		
P017	X	0.0000	EY	0.0000		
P018	X	0.0000	EY	0.0000		
P019	X	0.0000	EY	0.0000		
P020	X	0.0000	EY	0.0000		
X 00020.000						
				CAP INS MM		
EDIT	MODIFY	FIND	INITIALIZE	LOAD	SAVE	MM/INCH
F1	F2	F3	F4	F5	F6	F7

The number of points of each table is defined by means of the general machine parameter "NPCROSS", "NPCROSS2" and "NPCROSS3" respectively.

Each table defines:

- The position of the axis causing the error.
- The error suffered by the axis at that point.

Also, the current position of the selected axis is displayed and updated as the machine axis moves. This position is updated as the axis moves.

12.

MACHINE PARAMETERS
Cross compensation table

12.5 Operation with parameter tables

Once the desired table has been selected, the CNC will show its contents and the cursor can be moved line by line with the [↑] [↓] keys or page by page with the "page up" and "page down" keys.

There are also several options to operate with those tables. These options are shown with softkeys and they are:

Once any of those options has been selected, the user can move the cursor over this line by means of the [←] [→] keys. Also, with the [↑] key, the cursor may be placed over the first character of the editing window and, with the [↓] key over the last character.

12.

"EDIT" softkey

With this option it is possible to edit the selected parameter. Once this option has been selected, the softkeys will change colors and they will appear over white background showing the information corresponding to the type of editing possible at that point.

In those tables corresponding to leadscrew and cross compensation, the position values of the axis must be edited as follows:

1. Move the axis and when the error is found large enough to be considered, press the softkey corresponding to this axis.
2. The CNC will include, in the editing area, the name of the axis followed by the position value corresponding to that point. This value can be modified if so desired.
3. Press the softkey corresponding to the error and key in its value.

Once the parameter is edited, press [ENTER]. This new parameter will be included in the table and the cursor will be positioned over it. The editing area will be cleared, thus allowing other parameters to be edited.

Press [ESC] to quit this mode.

"MODIFY" softkey

With this option it is possible to modify the selected parameter. Before pressing this softkey, the desired parameter must be selected.

When selecting this option, the softkeys will change their color to a white background and they will show the various editing options.

By pressing [ESC], the information displayed in the editing window (corresponding to the selected parameter) will be cleared. From this point on, a new value can be entered.

To quit the block modifying mode, press [CL] or [ESC] to clear the editing window and then press [ESC] again. The selected parameter will not be modified.

Once this modification has concluded, press the [ENTER] key to validate it. The new parameter will replace the previous one.

"FIND" softkey

This option is used to find a specific text within the selected table.

When selecting this option, the softkeys will show the following options:

BEGINNING	When pressing this softkey, the cursor positions over the first parameter of the table quitting this option.
END	When pressing this softkey, the cursor positions over the last parameter of the table quitting this option.
PARAMETER	When pressing this softkey, the CNC will request the number of the parameter to be found. Key in that number and press [ENTER]; the cursor will be positioned over the indicated parameter quitting this option.

"INITIALIZE" softkey

With this option it is possible to reset all the parameters of the selected table to their default values. These default values are indicated in the chapter corresponding to machine parameters in the installation manual.

"LOAD" softkey

The tables may be loaded from the hard disk (KeyCF") or a peripheral device or a PC through the serial line (RS232C).

The transmission starts after pressing the corresponding softkey. When using a serial line, the receptor must be ready before starting the transmission. To interrupt the transmission, press the "ABORT" softkey.

If the length of the table received does not coincide with the current table length, the CNC will act as follows:

- If the table received is shorter than the current one, the received lines are modified and the rest remain with their previous values.
- If the table received is longer than the current one, all the lines of the table are modified and when detecting that there is no more room, the CNC will issue the corresponding error message

"SAVE" softkey

The tables may be saved into the hard disk (KeyCF") or a peripheral device or a PC through the serial line (RS232C).

The transmission starts after pressing the corresponding softkey. When using a serial line, the receptor must be ready before starting the transmission. To interrupt the transmission, press the "ABORT" softkey.

"MM/INCHES" softkey

Every time this softkey is pressed, the CNC will change the display format of those parameters affected by these units from millimeters to inches and vice versa. The lower right-hand window will indicate which units are selected (MM/INCH).

Note that this change does not affect the general machine parameter "INCHES" which indicates the measuring units by default.

12.

MACHINE PARAMETERS
Operation with parameter tables

FAGOR 

CNC 8055
CNC 8055i

.T. MODEL
SOFT: V01.3x

12.

MACHINE PARAMETERS

Operation with parameter tables



CNC 8055
CNC 8055i

-T- MODEL
SOFT: V01.3x

In this operating mode it is possible to know the configuration of the CNC as well as testing the system.

The CNC offers the following softkey options:

- System configuration.
- Hardware test.
- Tests.
- Adjustments.
- User.
- Hard disk.



CNC 8055
CNC 8055i

-T- MODEL
SOFT: V01.3X

13.1 Configuration

This option shows the current system configuration. Once this option has been chosen, two new softkeys will appear in order to select the hardware configuration or the software configuration of the system.

Hardware configuration.

This option displays the following information:

Central Unit (CPU) configuration

It indicates the current configuration of the CNC's central unit: Power supply, boards, video, CAN, etc.

CNC RESOURCES

It indicates, in Kb, the size of the user RAM memory, of the system and the memory space of the hard disk (KeyCF).

PLC RESOURCES

It indicates whether the PLC is integrated into the CPU-CNC and the number of inputs and outputs, local and remote.

LCD ADJUSTMENT (softkey available with monochrome LCD monitors)

Pressing this softkey shows new softkeys for adjusting the brightness/contrast over the adjustment screen.

- The [+] and [-] softkeys may be used to adjust the brightness/contrast.
- Pressing the [RESTORE] softkey restores the previous values.
- Pressing the [SAVE] softkey assumes the new values.

Software configuration

This option shows:

- The available software options.
- The software version installed.
The version for the CNC and for the hard disk (KeyCF).
- The id codes of the unit. They are only to be used by the Service Department.
- The softkey to update the version.

When updating the software version with this softkey, it is not necessary to turn the CNC off and back on or actuate the external switch to update the software version.

The "CODE VALIDATION" softkey must be used after consulting with the Service Department when wishing to implement more software features.

13.

DIAGNOSIS
Configuration



CNC 8055
CNC 8055i

-T- MODEL
SOFT: V01.3x

13.2 Hardware test

This option checks the power supply voltages corresponding to the system and to the boards as well as the internal temperature of the central unit. It displays the following information:

Supply voltage

It indicates the voltage of the lithium battery and the voltages supplied by the power supply. The voltages supplied by the power supply are internally used by the CNC.

Next to the voltages, it displays the value range (maximum and minimum values), the real value and whether it is OK or not.

Board voltage

It indicates which boards must be supplied with 24 Vdc and whether each one of them is properly supplied.

Inside temperature

It shows the value range (maximum and minimum values), the inside temperature of the Central Unit and whether that value is OK or not.

13.

DIAGNOSIS
Hardware test

FAGOR 

CNC 8055
CNC 8055i

-T- MODEL
SOFT: V01.3x

13.3 Tests

Memory test

This option checks the status of the internal CNC memory, that of the memory available for the user and for the system.

In order to perform this test, the PLC program must be stopped. If it is running, the CNC will ask the operator whether it is to be stopped or not.

Code test

This option checks the status of the internal CNC Flash memory. These memories contain the CNC software version currently installed.

Hard disk test

Accessing this screen runs a test on the disk. Testing the hard disk includes a test of the surface. This test is not carried out on a remote hard disk and the relevant message is displayed.

When detecting an error, it shows the relevant error message at the bottom of the window.

DIAGNOSIS		P..... N....		DNC	12:24:55
HARD DISK TEST					
PHYSICAL			LOGIC		
Model	* * *			Block size	4096 Bytes
Physical	984	16/	32	Total blocks	62846
Logic	984	16/	32	Free blocks	40150
MOUNTING			Occupied blocks 22696		
Ok			Sector/Cluster 8		
			Label BCB		
Ok				CAP	INS

This mode shows the following information:

- Physical information.
Hard disk model installed and information on the physical and logic partition (cylinders, heads and sectors). The physical and logic partitions might not be the same.
This information is only displayed for the local hard disk. When having a remote hard disk, this information is not available.
- Logic information.
Size in bytes of each of the blocks the disk is divided into. Total number of blocks in the disk, free and occupied. Number of sectors in a cluster.
The label is the name given to the disk when formatting it.
- Mounting information.
If no error occurred, it shows the message "OK".
Local hard disk: In case of error, it indicates the error number and the mounting stage where it came up.
Remote hard disk: In case of error, it only shows a message indicating the type of error.



CNC 8055
CNC 8055i

.T. MODEL
SOFT: V01.3X

13.4 Adjustments

13.4.1 Circle geometry test

This adjustment improves the axis reversal peaks. It consists in machining a circle (without compensation) and verifying it on the graph displayed at the CNC.

The following example shows a program that machines repetitive circles.

```
X0 Y0
G5 G1 F1000
N10 G2 X0 Y0 I20 J0
(RPT N10, N10) N50
M30
```

After selecting this program in the Execution mode and starting it, access the “Diagnosis > Adjustments > Circle Geometry test” mode and the CNC will display the following screen:



If the machine parameters are protected, it will request the access password because the bottom right of the screen shows some of them. When not knowing the password, those values cannot be changed, but it will be possible to access the screen and the circle geometry test.

The left side of the CNC screen shows the result of the test.

The data at the top right is refreshed by the CNC after the test is completed.

The data at the center right must be defined before running the test.

The bottom right side of the screen shows the parameters associated with the plane axes and the values to set them.

The graph on the left must be defined before running the test. To do that, define the data of the center right:

- Number of divisions to the left and to the right of the theoretical circle.
- Scale or value in microns of each division.
- Error margin or % of circle radius occupied by the error margin (divisions area).

Knowing the password, the values shown at the bottom right may be modified. The CNC assigns the new values to the relevant machine parameters; therefore, it is recommended to jot the initial values down.

13.

DIAGNOSIS
Adjustments

FAGOR 

CNC 8055
CNC 8055i

.T. MODEL
SOFT: V01.3x

Once the graphic display area and the machine parameters have been defined, capture the data by pressing the following softkeys:

- | | |
|------------|--|
| SIMPLE | It deletes the current graph and draws, over the theoretical circle, the machining error enlarged according to the defined scale until a full circle is drawn or until the STOP softkey or [ESC] key is pressed. |
| CONTINUOUS | It deletes the current graph and draws, over the theoretical circle, a series of circles with the machining error enlarged according to the defined scale until the STOP softkey or [ESC] key is pressed. |
| DELETE | It may be pressed at any time, even while drawing the graph. It deletes the screen and resets the statistics shown at its right. |

During continuous graphics, it is possible to modify the machine parameters and view the new graph over the previous one, or press the DELETE softkey to only display the new one.

The data shown by the CNC at the top right is updated while capturing data.

- | | |
|-------------------|--|
| Δ internal | Maximum negative value of the error over the theoretical value, in microns or ten-thousandths of an inch and its angular position. |
| Δ external | Maximum positive value of the error over the theoretical value, in microns or ten-thousandths of an inch and its angular position. |

Once data capture is done, it draws two lines indicating the angular positions of both errors on the graph. They appear in dashed lines when the error exceeds the value assigned to the display area in its quadrant and it goes on to the opposite quadrant.



While capturing points for the geometry test, the execution graphics stops drawing.

13.4.2 Oscilloscope

The oscilloscope function is a help tool to adjust the CNC and the drives. With this tool, it is possible to represent 4 previously selected variables and manipulate CNC machine parameters and variables. When using Fagor drives with Sercos or CAN, the drive parameters may also be adjusted.

When requesting information (variable or parameter) of a drive that is not connected via Sercos or CAN or has an old software version, the message "Variable does not exist" will be displayed.



It must be borne in mind that the oscilloscope is only an assistance tool for the adjustment; it is always up to the technician to decide which one is the best adjustment.

It is possible to access the oscilloscope from the main screens of the jog and execution modes by pressing "7" and then "1".

How to operate

The way to operate with the oscilloscope is summarized as followed:

1. Execute a part-program to move the axis or axes to be adjusted.
The program must execute a nonstop back-and-forth movement.
2. Once the program starts running, access the oscilloscope and define the variables to be analyzed, the trigger conditions and the machine parameters of the CNC or the drive to be modified.
From the oscilloscope, only certain machine parameters may be modified and it will also be necessary to know the protection password if they are protected.
3. Start the oscilloscope, capture the data and then analyze it. While capturing data, the defined data may be modified to check the system's response to different adjustments.
Repeat the capture, the analysis and the modification of parameters until obtaining the best machining conditions.

After adjusting the axes individually, readjust the interpolating axes together.

Operating the oscilloscope

To enter or modify a data on the screens, it must be selected and it must have the editing focus.

Use the [↑] [↓] keys to select another editable data or field. It is a rotary selection, if the [↑] key pressed when the first element of the screen is selected, the focus goes to the last element whereas if the [↓] is pressed when the last element is selected, the focus goes to the first element.

Not all the fields are editable, only the ones that may be selected can be edited, those having the focus. There are two types of editable fields:

- Editable values:
They may be assigned a value, either a two-digit number or alphanumeric (numbers and letters). Before validating the data, it is checked out and if it is not correct, it will not be accepted and a warning message will be issued.
- Values that may be selected:
The possible data are fixed one of them must be selected. Use the [←] [→] keys to see the possible values. For this type of values that are icons, the [White/Green] key has the same effect as the [→] key.

13.

DIAGNOSIS
Adjustments

FAGOR 

CNC 8055
CNC 8055i

.T. MODEL
SOFT: V01.3x

Softkey menu

Accessing the oscilloscope mode enables the following softkeys:

Scale / Offsets	To change the amplitude of each signal, move them vertically or adjust the time base for all of them.
Analysis	To analyze, using 2 cursors, each signal of the last data capture.
Parameters	To assign new values to the machine parameters of the CNC and drive that have been defined in the "Configuration" screen.
Configuration	To define the variables to be analyzed, the trigger conditions and the machine parameters of the CNC or the drive that may be modified.
Actions	It shows various softkeys to modify the data of each field (amplitude of the signals, vertical movement, time base adjustment, position of the cursors, etc.).
Start	It captures data according to the conditions set on the "Configuration" screen to be analyzed later on.

13.**DIAGNOSIS**
Adjustments**"Configuration" softkey**

To define the variables to be analyzed, the trigger conditions and the machine parameters of the CNC or the drive to be modified.

It offers 2 screens, one to set the parameters and the other one to define the variables and trigger conditions. On the screen for defining variables and the trigger condition, it is possible to go from block of elements to another using the [page up] and [page down] keys.

Definition of variables

The oscilloscope has 4 graphics channels (CH1, CH2, CH3, CH4). The following data must be defined in each channel.

- The code or name of the variable to be shown.
- The color used to show the variable on the graph.
- Whether the channel will be visible or not.

The hidden channels are not shown graphically (they are not shown on the screen after the data capture). This type of channels are useful when using this channel to set the trigger condition.

When defining a variable that cannot be captured, an error message will be issued. If no variable is to be captured in a channel, just leave the name field blank. If all 4 channels are deactivated (without associated variable) no capture is possible.



CNC 8055
CNC 8055i

-T- MODEL
SOFT: V01.3x

CNC variables that may be assigned to a channel

Indicate the desired variable.

Example: ANAI1 FREAL FLWEX.

Variable	Description
ANAI(1-8)	Voltage of input 1-8.
ANAO(1-8)	Voltage to apply to output 1-8.
FREAL	Actual (real) CNC feedrate.
FREAL(X-C)	Actual (real) X-C axis feedrate
FTEO(X-C)	Theoretical X-C axis feedrate
FLWE(X-C)	X-C axis following error.
ASIN(X-C)	"A" signal of the CNC's sinusoidal feedback for the X-C axis.
BSIN(X-C)	"B" signal of the CNC's sinusoidal feedback for the X-C axis.
DRPO(X-C)	Position indicated by the Sercos drive of the X-C axis.
SREAL	Real spindle speed
FTEOS	Theoretical spindle speed.
FLWES	Spindle following error.
ASINS	"A" signal of the CNC's sinusoidal feedback for the spindle.
BSINS	"B" signal of the CNC's sinusoidal feedback for the spindle.
DRPOS	Position indicated by the Sercos drive of the spindle.
SSREAL	Real speed of the second spindle.
SFTEOS	Theoretical speed of the second spindle.
SFLWES	Following error (lag) of the second spindle.
SASINS	"A" signal of the CNC sinusoidal feedback for the second spindle.
SBSINS	"B" signal of the CNC sinusoidal feedback for the second spindle.
SDRPOS	Position indicated by the Sercos drive of the second spindle.

Fagor Sercos or CAN drive variables that may be assigned to a channel

Indicate the desired axis or spindle and variable, separated by a period. The auxiliary spindle is identified with the prefix "AS".

Example: X.CV3 Y.SV1 S1.SV2 AS.SV1

Variable	Description
CV3	CurrentFeedback
SV1	VelocityCommand
SV2	VelocityFeedback
SV7	VelocityCommandFinal
TV1	TorqueCommand
TV4	VelocityIntegralAction
RV1	FeedbackSine
RV2	FeedbackCosine
RV51	Feedback2Sine
RV52	Feedback2Cosine

13.

DIA GNOSIS
Adjustments



CNC 8055
CNC 8055i

.T. MODEL
SOFT: V01.3x

Trigger conditions

The following data is available to define the trigger conditions.

- Channel

It indicates which variable or channel (CH1, CH2, CH3, CH4) is to be used as reference or trigger condition.
- Trigger

It indicates when the data capture begins. When selecting a trigger, the trigger condition must be specified with the "flank", "level" and "position" data.

If not selected, the data capture begins when the user gives the command to begin (the "flank", "level" and "position" data is ignored).
- Flank

It is taken into account when the trigger has been selected. It may be up-flank (leading edge) or down-flank (trailing edge).

With an up flank, the data capture begins when in a sample the data value is lower than the level and in the next sample the value is greater than or equal to the level.

With a down flank, the data capture begins when in a sample the data value is greater than the level and in the next sample the value is lower than or equal to the level.
- Level

It is taken into account when the trigger has been selected.

It sets the value to be assumed by the variable to start capturing data.
- Position (%)

It is taken into account when the trigger has been selected. It is defined as a percentage, between 0% and 100%.

It indicates the number of samples to be taken before the trigger. For example, a 10% position indicates that 10% of the total number of programmed samples will be taken before the trigger and the remaining 90% after that instant.

The trigger condition starts evaluating after having the indicated % of samples. If the position is defined as 50% and the trigger condition takes place after taking 10% of the samples, it is ignored until capturing 50% of the samples.
- Number of samples

It indicates the number of sample to be captured. It is common to all the channels. Value between 1 and 1024.

The sample will be taken at the same time in all the channels so they are synchronized.
- Sample T

It indicates the sampe period or the time period between data captures. It is given in milliseconds, integers between 1 and 1000 (between 1ms and 1s).

When analyzing CNC variables, the sample period must be a multiple of the loop time. If it is not, a message is displayed indicating that the sampling period has been automatically rounded off.

The sample time may be shorter than the CNC loop time only when analyzing 1 or 2 variables of the same drive.

When the requested number of variables forces a reconfiguration of the CNC's Sercos or CAN interface, a warning message is issued requesting its confirmation.
- Mode

It indicates the type of data capture, single or continuous.

With "single" capture, the process ends when the specified number of samples has been taken or when interrupted by the user.

In continuous capture mode, when the trace fills up the screen, the capture goes on except if the trigger has triggered; in that case the trace of the trigger remains until a new trigger is activated. The process goes on like that indefinitely until the user stops it.

13.**DIAGNOSIS**
Adjustments

CNC 8055
CNC 8055i

-T- MODEL
SOFT: V01.3x

- Superimposed channels

If this option is not selected, all the signals appear separated. The screen is divided into as many horizontal strips as active and visible channels have been defined. The signals are shown with their own graphic zero and ordered from top to bottom in the defined order (CH1, CH2, CH3, CH4).

If this option is selected all the signals appear superimposed, with a single graphic zero located at the center of the screen.

During the analysis of the signals, it is possible to change modes by pressing the [M] key.

Machine parameter setting

The parameters defining page shows the definition code on the left column, the parameter name on the center column and the maximum and minimum values on the right column.

- To add a parameter to the list, select the row for the parameter, enter the definition code and press [ENTER]. If the parameter is valid, the rest of the fields are updated and if not, it issues a warning.
- To replace a parameter from the list, select the parameter to be replaced, enter the definition code of the new parameter and press [ENTER]. If the previous content has been deleted and no code is entered, the line appears empty.
- The [Add a parameter to the list] softkey enters a new empty line above the currently selected line.
- The [Eliminate parameter] softkey eliminates the currently selected line and shifts all the ones below upwards.

The parameters are always shown in the same place where they were defined and the empty rows appear blank.

When a parameter is changed, the CNC machine parameter table and the drive's work parameters are updated. The [Save parameters] softkey is also activated. It is recommended to save the parameter tables that have been changed, those of the CNC into the hard disk (KeyCF) and those of the drive in its FLASH. If only the CNC parameters have been changed, the drive tables remain unchanged and vice versa.

Once the values saved are the same as the ones edited last, the softkey disappears until a new modification is made.

CNC machine parameters that may be modified

General machine parameters: Enter the indicator of the general parameter and the parameter number separated with a dot.

Example: G.P161

Parameter	Number	Update
TLOOK	P161	Beginning of program execution
CODISET	P147	Immediate

Machine parameters of an axis: Indicate the axis and the parameter number separated by a dot.

Example: X.P18 Z.P23

Parameter	Number	Update
BACKLASH	P14	Immediate
ACCTIME	P18	Beginning of the next block
INPOSW	P19	Immediate
MAXFLWE1	P21	Immediate
MAXFLWE2	P22	Immediate
PROGAIN	P23	Immediate
DERGAIN	P24	Immediate
FFGAIN	P25	Immediate
MINANOUT	P27	Immediate
SERVOFF	P28	Immediate
BAKANOUT	P29	Immediate



CNC 8055
CNC 8055i

.T. MODEL
SOFT: V01.3x

13.

DIAGNOSIS
Adjustments

Parameter	Number	Update
BAKTIME	P30	Immediate
REFDIREC	P33	Immediate
REFVALUE	P36	Immediate
MAXVOLT	P37	Immediate
G00FEED	P38	Beginning of the next block
MAXFEED	P42	Beginning of the next block
JOGFEED	P43	Beginning of the next block
ACCTIME2	P59	Beginning of the next block
PROGAIN2	P60	Immediate
DERGAIN2	P61	Immediate
FFGAIN2	P62	Immediate
JERKLIM	P67	Beginning of the next block
FLIMIT	P75	Beginning of the next block

Spindle machine parameters: Indicate the spindle (S, S1, S2) and the parameter number separated by a dot.

Example: S.P18 S1.P23 S2.P25

Parameter	Number	Update
MAXGEAR1	P2	Beginning of the next block
MAXGEAR2	P3	Beginning of the next block
MAXGEAR3	P4	Beginning of the next block
MAXGEAR4	P5	Beginning of the next block
ACCTIME	P18	Beginning of the next block
INPOSW	P19	Immediate
PROGAIN	P23	Immediate
DERGAIN	P24	Immediate
FFGAIN	P25	Immediate
MINANOUT	P27	Immediate
SERVOFF	P28	Immediate
REFDIREC	P33	Immediate
REFVALUE	P36	Immediate
MAXVOLT1	P37	Immediate
MAXVOLT2	P38	Immediate
MAXVOLT3	P39	Immediate
MAXVOLT4	P40	Immediate
OPLACET1	P45	Immediate
ACCTIME2	P47	Beginning of the next block
PROGAIN2	P48	Immediate
DERGAIN2	P49	Immediate
FFGAIN2	P50	Immediate
SLIMIT	P66	Immediate

A modification in the MAXGEAR(1..4) parameters sets the square corner mode even if a round corner has been programmed.



CNC 8055
CNC 8055i

.T. MODEL
SOFT: V01.3x

Drive parameters that may be modified.

Axis parameters. Indicate the axis, the name of the parameter and the set separated by a period.

Example: X.CP1.0 Y.CP20.2 Z.SP1.1

Save and load the configurations of the oscilloscope

The system permits saving the current configuration into a file in ASCII format. To do that, set general machine parameter STPFILE with the number to be assigned to the configuration file (the number must be other than 0). The configuration file may be treated like any other program, sent out via DNC or even edited.

When saving or loading a configuration, the CNC first checks if the file already exists in User RAM and if not, it will look for it in the hard disk (KeyCF).

Several configurations may be saved in the configuration file. Each configuration must be assigned a name of up to 40 characters.

The following softkeys are related to this feature.

Save	To save the current configuration, press the [Save] softkey and enter the name to save it with up to 40 characters. If there is a previously saved configuration with the same name, it will ask whether it must be replaced or not.
Load	To load a previously saved configuration, press the [Load] softkey and select it from the list on the screen. If the configuration makes not sense (for example, because the CNC does not have an axis that that configuration refers to), the CNC will warn the user and it will only load the portion of the configuration read until that error came up.
Delete	To delete one of the saved configurations, press the [Delete] softkey, select it from the list on the screen and press [ENTER].
Reset	Pressing the [Reset] softkey resets the current configuration. There are neither variables nor parameters selected and the rest of conditions (colors, trigger, etc.) assume the values assigned by default.

Access to PLC resources

From the configuration screen, the system can access the PLC resources. The following syntax must be used to access them:

- Marks: PLC.M1234
- Inputs: PLC.I25
- Outputs: PLC.O1
- Registers: PLC.R560
- Register Bit: PLC.B0R560
- Timers: PLC.T1
- Counters: PLC.C1

Access is also possible using the associated symbol.

Example: PLC.ENABLEX

An error will be issued when accessing a non-existent PLC resource.

"Scale / Offsets" softkey

To change the amplitude of each signal, move them vertically or adjust the time base for all of them.

The right side of the screen shows:

- The vertical scale or amplitude by square for each signal (next to the name of the variable).
- The horizontal scale or time base (t/div) for all the signals.

To change the amplitude, use the [▲] [▼] keys to place the focus in the "Scale" field of the desired variable. Then use the [◀] [▶] keys or [page up] [page down] to select one of the permitted values or press [X] for auto-scaling.

To move the signal vertically, use the [↑][↓] keys to place the focus in the "Offset" field of the desired variable. Then use the [←][→] keys or [page up] [page down] to move the signal or press one of these keys:

- [U] To move it up as high as possible
- [D] To move it down as low as possible
- [0] To center it.
- [X] For the CNC to scale it automatically.

When autoscaling a channel, the system determines the proper vertical scale and offset so the signal appears as enlarged as possible inside its graphic area.

To modify the time base of all the signals, use the [↑][↓] keys to place the focus in the "t/div" field. Then use the [←][→] keys or [page up] [page down] to select one of the permitted values or press [X] for auto-scaling.

To select another portion of the sample use the [↑][↓] keys to place the focus in the "Win" field. Then use the [←][→] keys or [page up] [page down] to move the signal or press one of these keys:

- [F] To show the beginning of the trace (First)
- [T] To show the trigger zone.
- [S] To show the final portion of the trace (second)
- [X] For the CNC to scale it automatically.

"Analysis" softkey

To analyze, using 2 cursors, each signal of the last data capture.

The right side of the screen shows:

- Next to each variable, the value (V1 and V2) of the signal in the position of each cursor and the difference between them (Dv).
- The position, in milliseconds, of each cursor (C1 and C2) and the time difference between them (Dt).

To select the first or second cursor, use the [↑][↓] keys to place the focus in the "C1" or "C2" fields respectively. Then use the [←][→] keys or [page up] [page down] to move the signal or press one of these keys:

- [F] To show the beginning of the trace (First)
- [T] To show the trigger zone.
- [S] To show the final portion of the trace (second)
- [X] For the CNC to scale it automatically.

To select another portion of the sample use the [↑][↓] keys to place the focus in the "Win" field. Then use the [←][→] keys or [page up] [page down] to move the signal or press one of these keys:

- [F] To show the beginning of the trace (First)
- [T] To show the trigger zone.
- [S] To show the final portion of the trace (second)
- [X] For the CNC to scale it automatically.

Holding the [←][→] keys pressed accelerates the movement.

13.

DIAGNOSIS
Adjustments



CNC 8055
CNC 8055i

-T- MODEL
SOFT: V01.3x

"Parameters" softkey

To assign new values to the machine parameters of the CNC and drive that have been defined in the "Configuration-Parameters" screen.

The machine parameters of the axis or the spindle are updated according to the criteria defined in the previous tables, the rest of the parameters are updated according to the general criteria:

- // It is necessary to press the keystroke sequence [SHIFT]+[RESET] or turn the CNC off and back on.
 - / Just press [RESET].
- The rest of the parameters (those unmarked) will be updated automatically, only by changing them.

If the password to the machine parameters has been defined (SETUPPSW), it will be requested when modifying a parameter for the first time. If entered correctly, it is stored in memory and it is not requested again unless the CNC is turned off. If the password is wrong, the parameter cannot be modified and it will be requested again the next time.

When a parameter is changed, the CNC machine parameter table and the drive's work parameters are updated. The [Save Parameters] softkey is also activated on the "Configuration - Parameters" screen.

We suggest to access that screen and press the [Save Parameters] softkey to save the parameter tables that have been changed, those of the CNC into the hard disk (KeyCF) and those of the drive in its FLASH. If only the CNC parameters have been changed, the drive tables remain unchanged and vice versa.

Once the values saved are the same as the ones edited last, the softkey disappears until a new modification is made.

"Actions" softkey

It is available on the following screens: "Parameter Editing", "Analysis" and "Scales /Offsets".

It is very useful when not having an alpha-numeric keyboard because it shows several softkeys to change the data of each field (amplitude of the signals, vertical movement, time base, position of the cursors, etc.)

"Start" softkey

It is available on the following screens: "Parameter Editing", "Analysis" and "Scales /Offsets".

It captures data according to the conditions set on the "Configuration" screen and enables the following softkeys:

- [Stop] Interrupts the capture and shows the data collected until then.
- [Stop continuous] Available when the capture is continuous. It interrupts the capture and shows the last full trace.

Once data capture has ended, or has been interrupted, it is possible to analyze the signals and modify the parameters that have been previously selected, in order to improve the machining conditions.

Repeat the capture, the analysis and the modification of parameters until obtaining the best machining conditions.

13.

DIAGNOSIS
Adjustments

FAGOR 

**CNC 8055
CNC 8055i**

-T- MODEL
SOFT: V01.3x

13.5 User

This option will execute the program which is selected with the general machine parameter "USERDIAG" in the user channel.

To quit its execution and return to the previous menu, press [ESC].

13.

DIAGNOSIS
User

13.6 Hard disk

Once this option has been selected, two softkeys will be displayed:

"Test" softkey

It check the status of the hard disk (user memory available). It takes about 30 minutes.

In order to perform this test, the PLC program must be stopped. If it is running, the CNC will ask the operator whether it is to be stopped or not.

"Compress" softkey

It compresses the hard disk by defragmenting it. It also includes a hard disk surface check. The duration of this test depends on the number of files it contains and on how defragmented the hard disk is.



CNC 8055
CNC 8055i

-T- MODEL
SOFT: V01.3x

13.7 Interesting notes

The CNC carries out a series of sequential tests. If the result obtained is not correct, it may stop axes feed and spindle rotation (by canceling their analog voltages and Enables), as well as stopping the execution of the PLC program or activating the external emergency output (O1).

Type of test	When doing	Stop axes and spindles	Stop the PLC	Activates the emergency output
Temperature	Always	Yes	No	Yes
Battery out	Always	No	No	No
Flash memory	From Diagnosis	Yes	Yes	Yes
RAM memory	From Diagnosis	Yes	No	Yes
External power supply.	EXEC/SIMUL	Yes	No	No
Board voltage	EXEC/SIMUL	Yes	No	Yes
PLC in execution	EXEC/SIMUL	Yes	---	Yes
PLC User errors	EXEC/SIMUL	Yes	No	No
PLC watchdog	PLC in execution	Yes	Yes	Yes

13.

DIAGNOSIS
Interesting notes

FAGOR 

CNC 8055
CNC 8055i

-T- MODEL
SOFT: V01.3x

13.

DIA GNOSIS

Interesting notes



CNC 8055
CNC 8055i

-T- MODEL
SOFT: V01.3x

Telediagnosis may be used to govern and monitor the status of the CNC from a remote PC. The remote PC used for telediagnosis must have the WinDNC software installed in it.

To use telediagnosis, first establish communication between the CNC and the PC either through the RS232 line, through Ethernet or with phone call.

To establish communication through a phone call, both the CNC and the PC must be connected to a modem. The call from a PC is made with the WinDNC and the call from the CNC is made from the mode: Status > DNC > Phone Call. Pressing this softkey shows a menu with the different types of phone calls available:

- Normal phone call.

It is a direct phone call between the CNC and the PC. Whoever establishes the connection incurs in its costs.

- Advanced phone call.

It is a direct phone call between the CNC and the PC. The CNC incurs in the connection costs because it is the one establishing the connection with the PC.

This option is similar to the previous one, but it provides faster telediagnosis. This type of connection uses TCP/IP protocol, thus not being necessary to configure an incoming connection at the PC.

- Internet phone call.

It is a connection made through internet. Both the CNC and the PC incur in the connection costs because both the CNC and the PC must be connected to the internet.

Telediagnosis through the Internet offers all the advantages of this type of connection. Usually, this type of connection costs less than a direct telephone call. When connecting through the Internet for the connection, the telediagnosis may sometimes be slower than making a direct telephone call.

No special machine parameter must be set at the CNC to carry out the telediagnosis. Only the machine parameters of the serial line or Ethernet must be properly set depending on the type of connection.

Telediagnosis



Once the connection has been made, access the telediagnosis option of the WinDNC at the PC. From then on, the CNC may be governed either from its own keyboard at the machine or remotely from the PC keyboard.

The PC will display the same information (screens) as the CNC. From the PC, it is possible to access the different CNC modes, modify tables and parameters (when knowing the password), simulate programs, etc. For safety reasons, it is not possible to move the axes of the machine or execute part-programs.

While in remote control mode, no other DNC command may be executed through the serial line; for example the execution of an infinite program.

Disabling the CNC screen and keyboard

The CNC screen and keyboard may be disabled from the WinDNC so the user cannot manipulate the CNC while telediagnosis is running.

When the keyboard is disabled, neither the feedrate override nor the CYCLE STOP button are disabled. These operations are carried out by activating and deactivating the corresponding icons on the left side of the telediagnosis screen.

End of telediagnosis

To end telediagnosis, select the END icon at the WinDNC. Ending telediagnosis does not end the connection between the PC and the CNC.



There are two ways to end the communication between the PC and the CNC; either from the PC or from the CNC.

- From the PC select the EXIT option at the WinDNC.
- At the CNC, in the window for phone calls, press HANG UP.

14.

CNC - PC COMMUNICATION. TELEDIAGNOSIS



CNC 8055
CNC 8055i

-T- MODEL
SOFT: V01.3x

14.1 Direct connection through the serial line or Ethernet

The direct connection is also possible either through the RS232 serial line or Ethernet. With the Ethernet connection it is possible to use a local network to access any CNC of the network from the PC.

The connection is established from the PC through the WinDNC. Refer to the WinDNC help for further information.

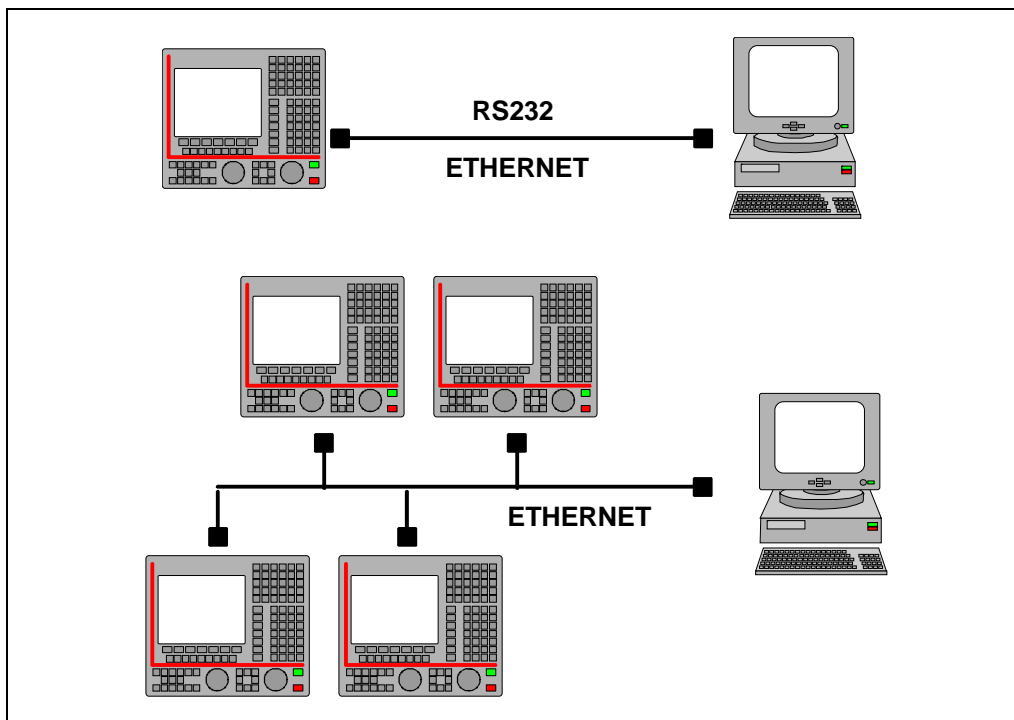

For the RS232 connection, the remote PC must have the WinDNC software (version V2.00 or later) installed in it. For the Ethernet connection, the remote PC must have the WinDNC software (version V4.00 or later) installed in it.

14.

CNC - PC COMMUNICATION. TELEDIAGNOSIS
Direct connection through the serial line or Ethernet

FAGOR 

CNC 8055
CNC 8055i

.T. MODEL
SOFT: V01.3x

14.2 Telephone connection from a PC

It is a direct phone call between the CNC and the PC. The PC incurs in the connection costs because it is the one establishing the connection with the CNC.

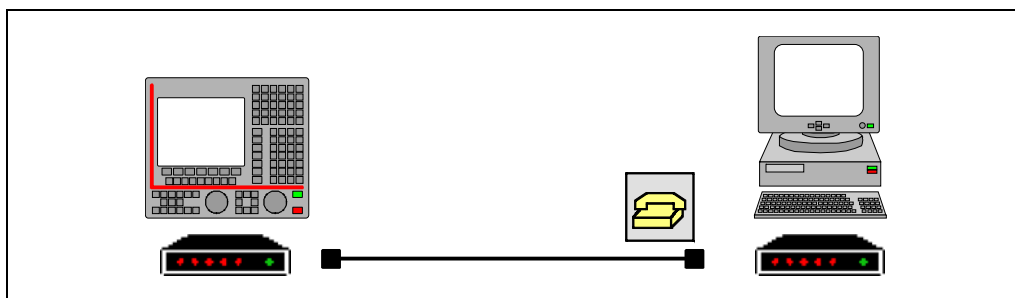

PC connection to the telephone line

It is recommended to first turn on the modem, then the CNC and then the remote PC, in that order. Connect the PC to the telephone line through a modem and execute the WinDNC application.



At the WinDNC, within the options for the serial line, select the "CALL" option. The WinDNC shows the following window to select the modem being used and the telephone number to dial (that of the CNC).

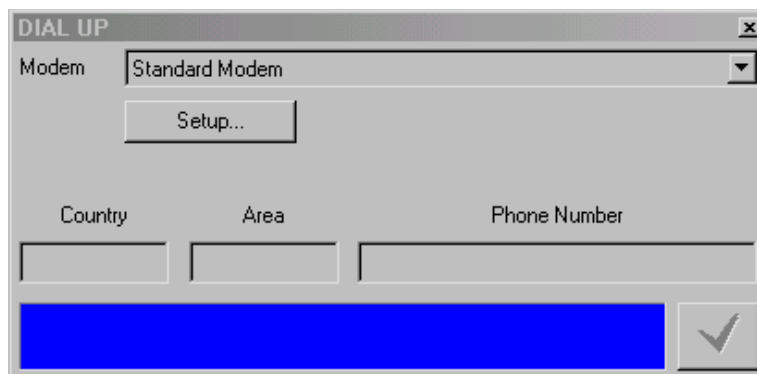

14.

CNC - PC COMMUNICATION. TELEDIA GNOSIS
Telephone connection from a PC



CNC 8055
CNC 8055i

-T- MODEL
SOFT: V01.3x

14.3 Normal phone call

It is a direct phone call between the CNC and the PC.

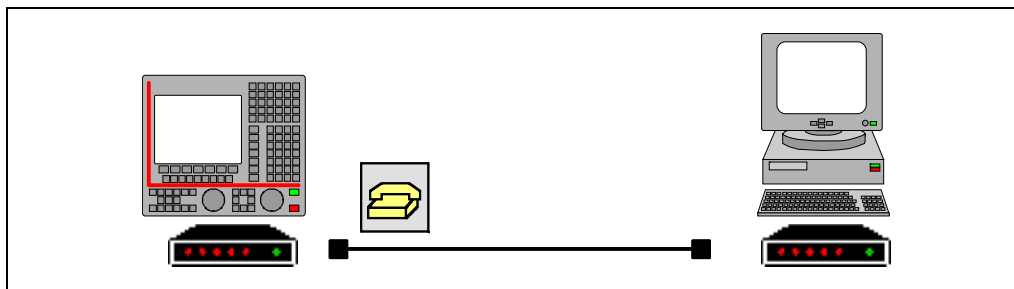

When pressing this softkey, the CNC displays a window to enter the phone number that the PC modem is connected to. If necessary, one must also set the outside line accessing code, the country code (if the PC is in another country) and the telephone extension.

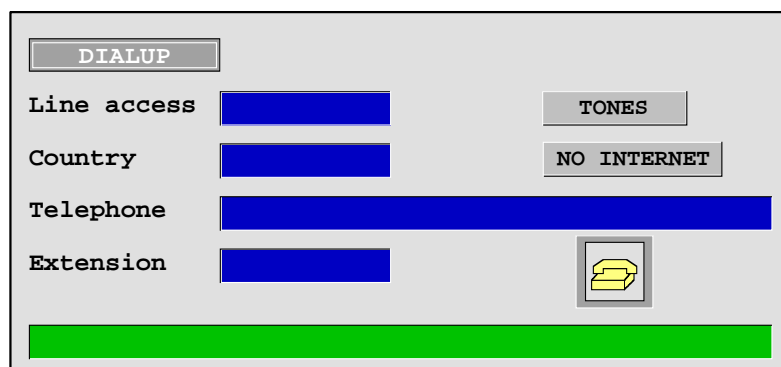

Once the phone number has been entered, it is possible to make a call by selecting the telephone icon and pressing [ENTER] or by pressing the "CALL" softkey. Likewise, to hang up, it may be done using the icon or the "hang up" softkey.

The bottom of the screen shows the warning and error messages that come up. To establish connection, the WinDNC of the PC must be in the call waiting mode.

14.

CNC - PC COMMUNICATION. TELEDIAGNOSIS
Normal phone call

14.4 Advanced phone call

It is a direct phone call between the CNC and the PC. This option is similar to the normal call, but it provides faster telediagnosis.

This type of connection uses TCP/IP protocol, thus not being necessary to configure an incoming connection at the PC.

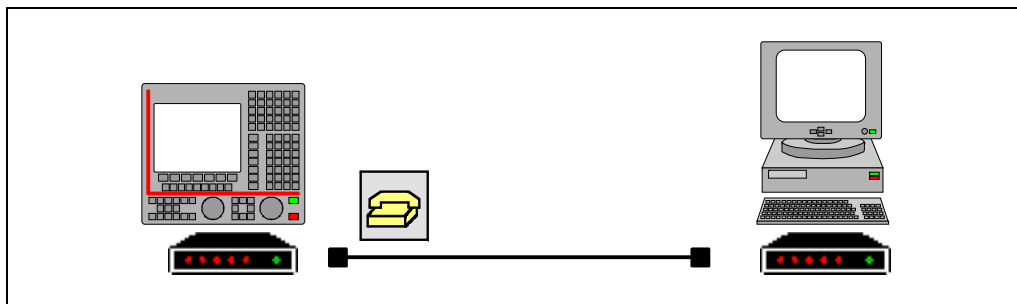

When pressing this softkey, the CNC displays a window to enter the phone number that the PC modem is connected to, the user name and the password. If necessary, one must also set the outside line accessing code, the country code (if the PC is in another country) and the telephone extension.

The user name and the password must be provided by the person performing the telediagnosis. The user name and the password may be up to 15 characters long.

DIALUP

Line access	<input style="width: 90%;" type="text"/>	<input type="button" value="TONES"/>	
Country	<input style="width: 90%;" type="text"/>	<input type="button" value="NO INTERNET"/>	
Telephone	<input style="width: 100%;" type="text"/>		
Extension	<input style="width: 90%;" type="text"/>		
User	<input style="width: 100%;" type="text"/>		
Password	<input style="width: 100%;" type="text"/>		

Once the phone number has been entered, it is possible to make a call by selecting the telephone icon and pressing [ENTER] or by pressing the "CALL" softkey. Likewise, to hang up, it may be done using the icon or the "hang up" softkey.

The bottom of the screen shows the warning and error messages that come up. To establish connection, the WinDNC of the PC must be in the call waiting mode.



The advanced telephone connection is unidirectional (one way). The WinDNC can receive and send files, enter into telediagnosis or carry out any operation. Nothing can be done with the DNC at the CNC.

14.

CNC - PC COMMUNICATION. TELEDIAGNOSIS

Advanced phone call



CNC 8055
CNC 8055i

.T. MODEL
SOFT: V01.3X

How to operate at the PC

While the CNC is dialing, the task bar will show an icon indicating the telephone access connection. At that moment, a new configuration must be created at the WinDNC. Select "Network Node" in the "Type" field and as IP address the one previously configured (in our example 10.0.68.71).

Press "OK" to finish creating the configuration and "Connect" to connect to the CNC.



This type of telediagnosis uses a standard Windows protocol which like other packs involves opening a communications port at the PC (incoming connection). Having this open port may let an undesired third party access the PC and even the local network.

To prevent undesired access, the PC should be disconnected from the local network during telediagnosis; once telediagnosis has concluded, the incoming connection must be disconnected.

Disconnecting the CNC from the Ethernet network during telediagnosis

For safety reasons, the CNC offers the operator the possibility to temporarily disconnect the CNC from the Ethernet network during the call. Pressing the "Call" softkey opens a new window for temporarily disconnecting the CNC from the Ethernet network. The CNC will connect to the network again when the call ends.

When the CNC disconnects from the Ethernet network, the Ethernet status screen will show the message "Ethernet not running".

14.

CNC - PC COMMUNICATION. TELEDIAGNOSIS
Advanced phone call

FAGOR

CNC 8055
CNC 8055i

.T. MODEL
SOFT: V01.3X

14.4.1 Configuration of an incoming connection at the PC.

First, configure the PC to accept telephone calls.

In the "Configuration" option of the "Start" menu, select "Network connections" and chose the option for creating a new connection. It will show the Windows help to create connections that permits configuring the connection step by step. Press the –OK– button to go on to the next step.

Follow the instructions shown on the screen to configure the connection; refer to the Windows help for additional information. Define the following data in each step:

1. The first step is to select the type of network connection that must accept incoming connections. Depending on the operating system of the PC (Windows 2000 or XP) the first steps will be different.
 - On Windows 2000, select the option "Accept incoming connections".
 - On Windows XP, first select the option "Configure an advance connection" and, in the next step, the option "Accept incoming connections".
2. Then, select and configure the device through which to connect, in this case the modem. To select it, activate the selection box next to the device.

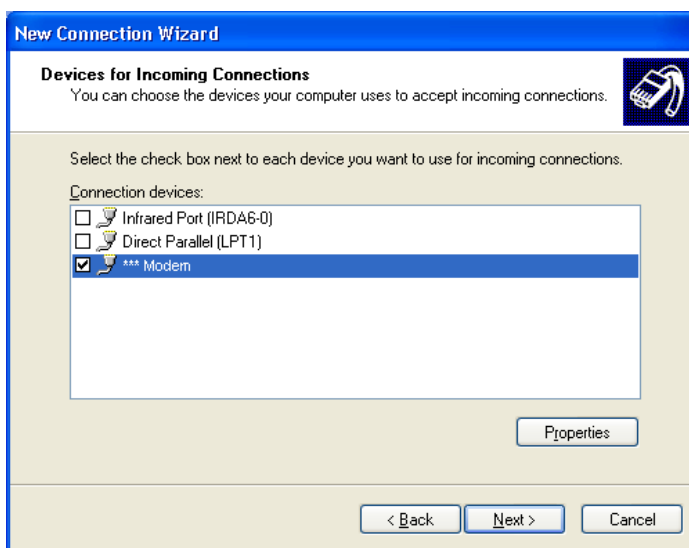

To prevent undesired access to the PC, once telediagnosis has concluded, the modem must be disabled. To do that, deactivate the selection box next to the device.

To configure the modem, select the properties button. A window will appear with the connection preferences. If necessary, refer to the documentation of your modem for the proper configuration. In most cases, the default modem configuration will be valid. As an example, the following values may be used.

As basic properties of the modem (the values are examples).

Cancel the call if not connected in ... (sec)	60 sec
Port speed	115200
Data protocol	Standard EC
Compression	Enabled
Flow control	Hardware

14.

CNC - PC COMMUNICATION. TELEDIAGNOSIS
Advanced phone call



CNC 8055
CNC 8055i

-T- MODEL
SOFT: V01.3x

As advanced properties of the modem (the values are examples).

Data bits	8
Parity	None
Stop bits	1
Modulation	Standard

If it offers the option to display the window for the dialing terminal, select the options so it is not shown in any case.

- The next step refers to the virtual connections. Choose the option "Do not allow private virtual connections".
- To make the connection, define the users allowed to connect with the PC. The window shows a list of users. To define a new user, press the –Add– button.
To add a new user, define the name, the password and password confirmation. The "Full name" field is optional.
- The last step consists in configuring the network components. In this case, we'll use the Internet protocol TCP/IP.

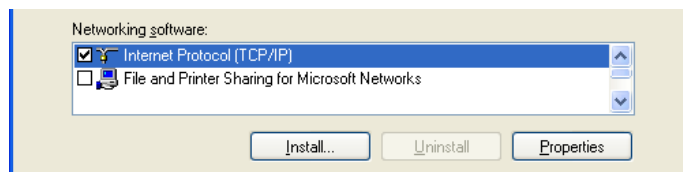

Select the TCP/IP protocol from the list of components and press the properties button.

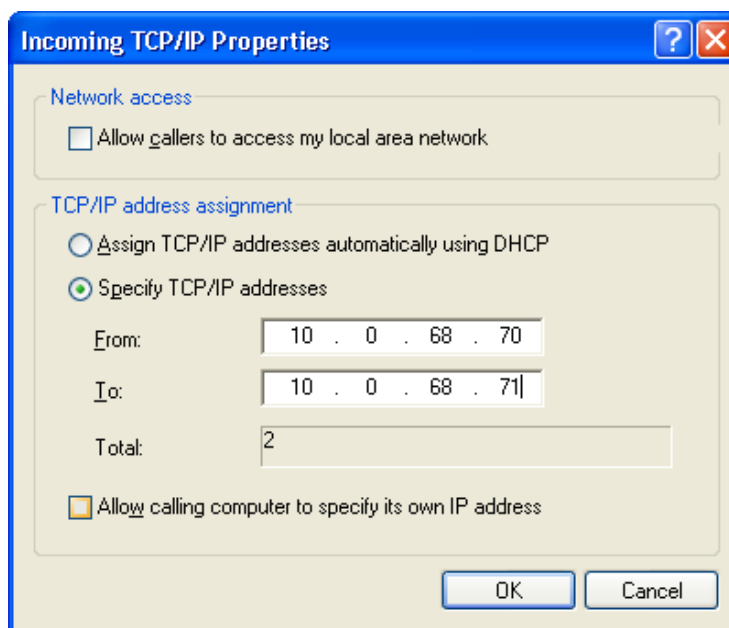

Indicate the TCP/IP addresses. Enter in the "From" field an address that belongs to the local network where the PC is and in the "For" field the next one.

For safety, deselect the option that lets the caller access the local network.



For example, if the network the PC is in uses 10.0.xx.xx type addresses, the "From" field may use the address 10.0.68.70 and the "For" the next one, i.e. 10.0.68.71, if they are not being used.

- Define the name by which the new connection must be recognized. This is the name that will appear on the PC's net directory. Just select it from the list to start the connection.

14.5 Internet phone call

It is a connection made through internet. Telediagnosis through the Internet offers all the advantages of this type of connection. When connecting through the Internet for the connection, the telediagnosis may sometimes be slower than making a direct telephone call.

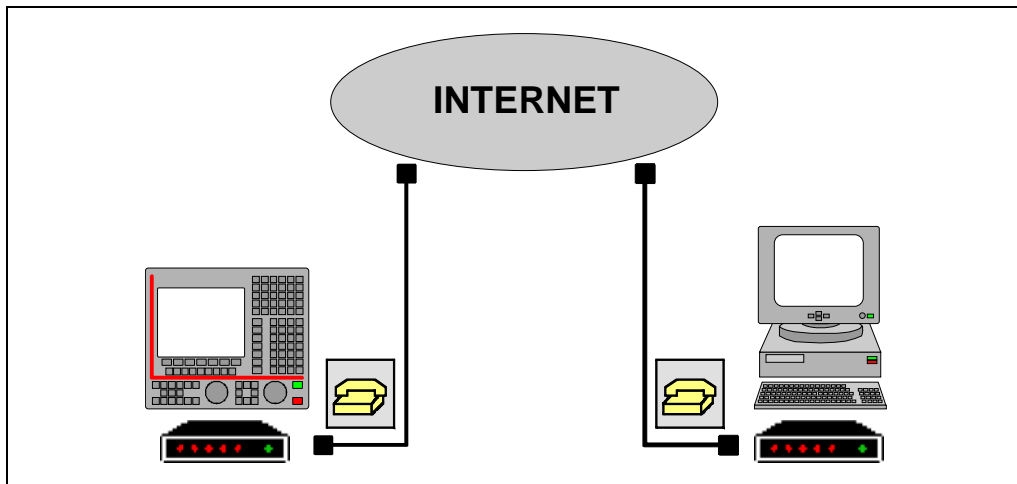

When pressing this softkey, the CNC displays a window to enter the phone number, the user name and the password. If necessary, one must also set the outside line accessing code, the country code (if the PC is in another country) and the telephone extension.

The telephone number, the user name and the password must be provided by the internet connection provider. The user name and the password may be up to 15 characters long.

The screenshot shows a 'DIALUP' configuration window. It has a title bar with the word 'DIALUP'. Below the title bar are several input fields and buttons. On the left, there are labels for 'Line access', 'Country', 'Telephone', 'Extension', 'User', and 'Password', each followed by a blue rectangular input field. On the right side, there are two buttons: 'TONES' and 'INTERNET'. Below these buttons is a small icon of a network card. At the bottom of the window, there is a green horizontal bar.

Once the connection has been made, the bottom of the screen will show the IP address. This address must be communicated to the person who is going to telediagnose from the PC.



The Internet connection is unidirectional (one way). The WinDNC can receive and send files, enter into telediagnosis or carry out any operation. Nothing can be done with the DNC at the CNC.



CNC 8055
CNC 8055i

-T- MODEL
SOFT: V01.3x

PC connection

There are many ways to connect the PC to the Internet, through a modem, LAN, ADSL, etc. If it is connected through a firewall (safety filters for the connection), it may have to be configured so it lets the Fagor telediagnosis data through. These communications are established through the TCP/IP 3873 port.

Once the PC is connected to the Internet, Create a new configuration at the WinDNC. In the "Type" field, select "Network Node" and the IP address that the CNC offers on the screen.

Press "OK" to finish creating the configuration and "Connect" to connect to the CNC.



Connecting through a modem leaves an open way to the local network of the PC. Having this open way may let an undesired third party access the local network.

To prevent undesired access, the PC should be disconnected from the local network during telediagnosis.

Disconnecting the CNC from the Ethernet network during telediagnosis

For safety reasons, the CNC offers the operator the possibility to temporarily disconnect the CNC from the Ethernet network during the call. Pressing the "Call" softkey opens a new window for temporarily disconnecting the CNC from the Ethernet network. The CNC will connect to the network again when the call ends.

When the CNC disconnects from the Ethernet network, the Ethernet status screen will show the message "Ethernet not running".

14.

CNC - PC COMMUNICATION. TELEDIAGNOSIS
Internet phone call

FAGOR

CNC 8055
CNC 8055i

.T. MODEL
SOFT: V01.3x

14.

CNC - PC COMMUNICATION. TELEDIA GNOSIS
Internet phone call



CNC 8055
CNC 8055i

-T- MODEL
SOFT: V01.3x



14.



**CNC 8055
CNC 8055i**

-T- MODEL
SOFT: V01.3x

