

工程/案件 PROJECT/CASE		工程編號 JOB. NO.		設計 DESIGN		審核 APPR.		修改 REVISE	
圖樣內容 SHEET CONTENTS		檔案編號 FILE.		繪圖 DRAW		核對 CHK.		日期 DATE	
Surface Grinder									

ACER Taiwan

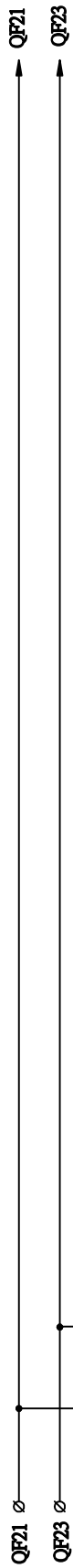

2mmf

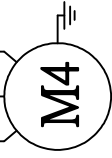
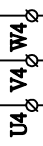
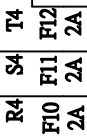
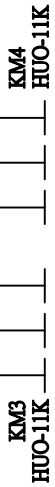

Y Axis Rapid motor
AC220V, 1/2HP, 2A(818)

A		B		C		D		E		F		G		H			
工程/案件 PROJECT/CASE												工程編號 JOB. NO.		審核		修改	
圖樣內容 SHEET CONTENTS												權責編號 FILLB.		校對		日期	
Surface Grinder														CHK.		DATE	
												DESIGN		APPR.		REVISE	
												DRAW		CHK.		DATE	

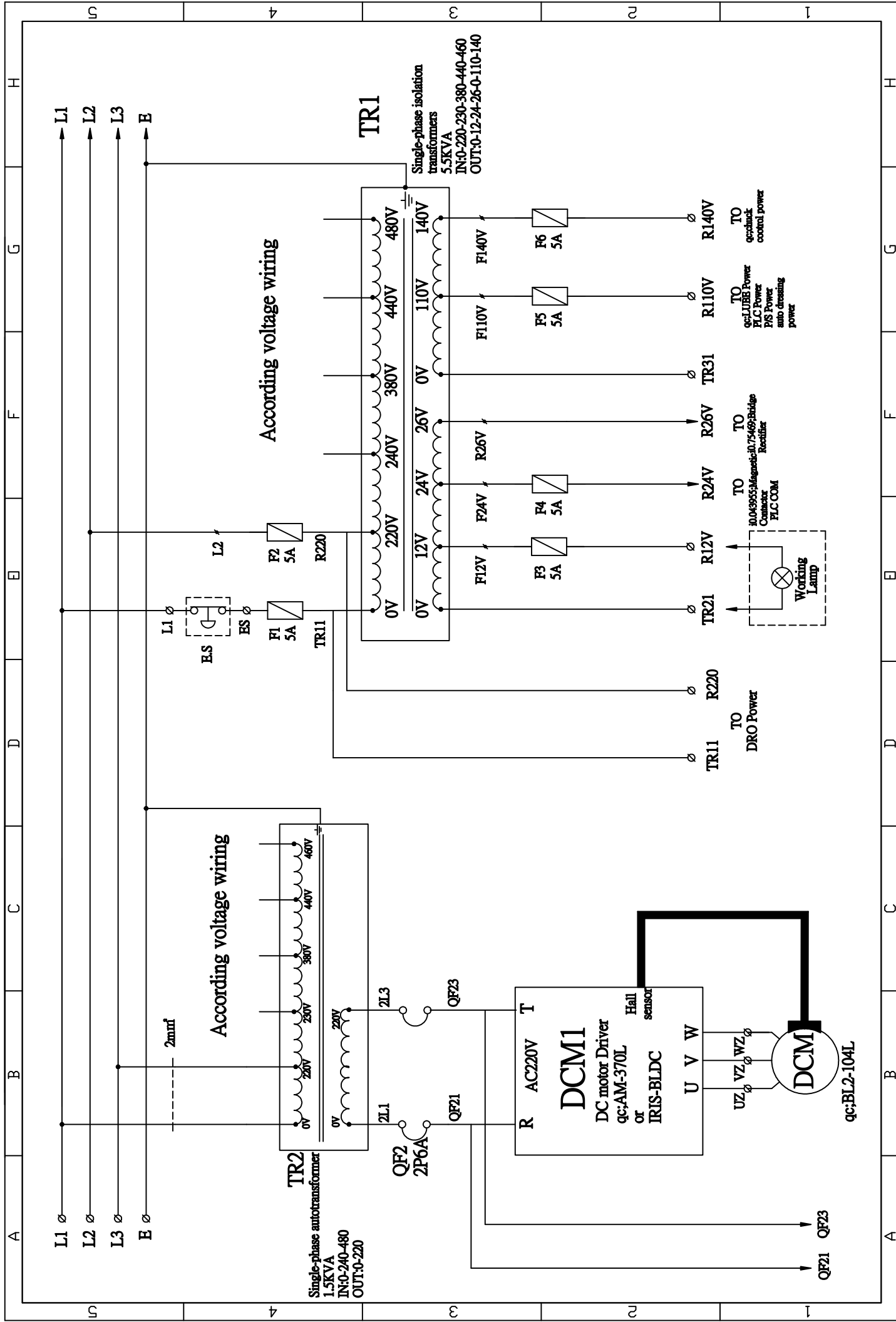

ACER Taiwan		Surface Grinder		DATE		2011/06/16	
工程/案件	PROJECT/CASE	設計	DESIGN	審核	CHK.	修改	REVISE
圖樣內容	SHBTT CONTENTS	繪圖	DRAW	校對	CHK.	日期	DATE
		工程編號	JOB. NO.				
		檔案編號	F.I.L.B.				

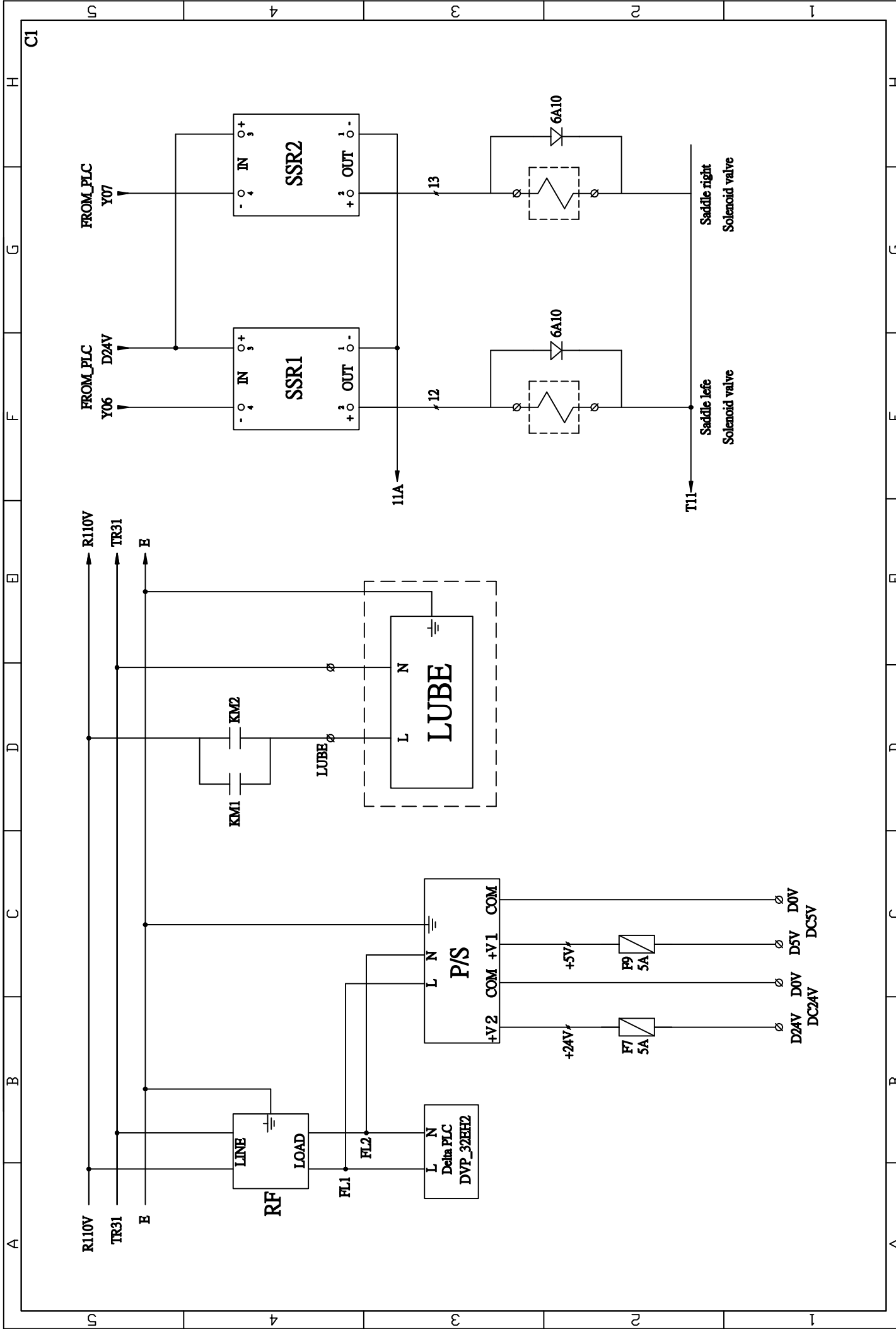

ACER Taiwan		Surface Grinder	
工程/案件 PROJECT/CASE	工程編號 JOB. NO.	設計 DESIGN	審核 CHK.
圖樣內容 SHBET. CONTENTS	檔案編號 FILB.	繪圖 DRAW	校對 CHK.
		修改 REVISE	日期 DATE

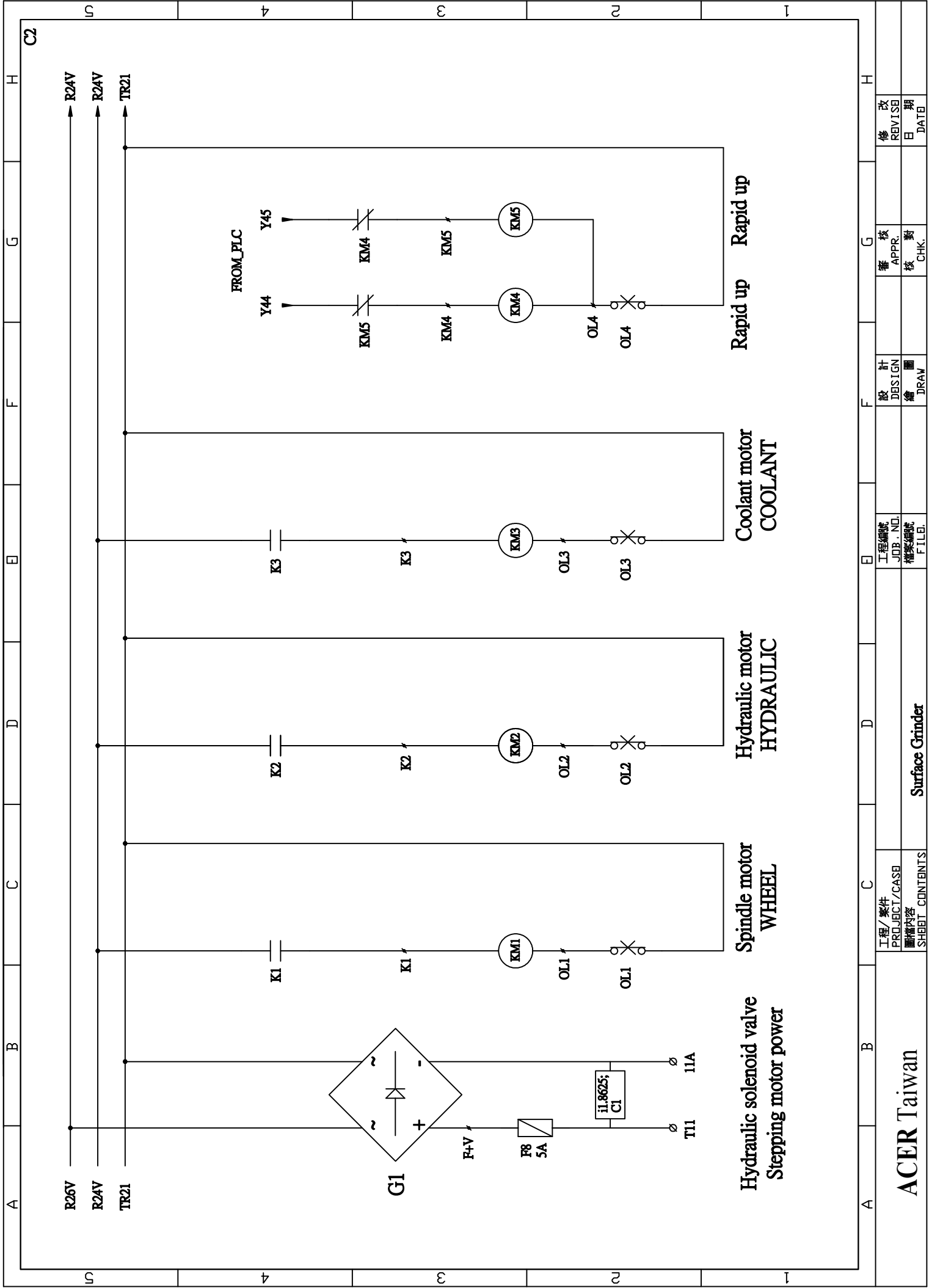

ACER Taiwan		Surface Grinder		Surface Grinder	
工程/案件 PROJECT/CASE	工程編號 JOB. NO.	設計 DESIGN	審核 APPR.	修改 REVISE	日期 DATE
圖樣內容 SHBET. CONTENTS	檔案編號 FILEB.	繪圖 DRAW	校對 CHK.	日期 DATE	日期 DATE

DVP-32EA2

D5V D24V D0V

D24V D0V

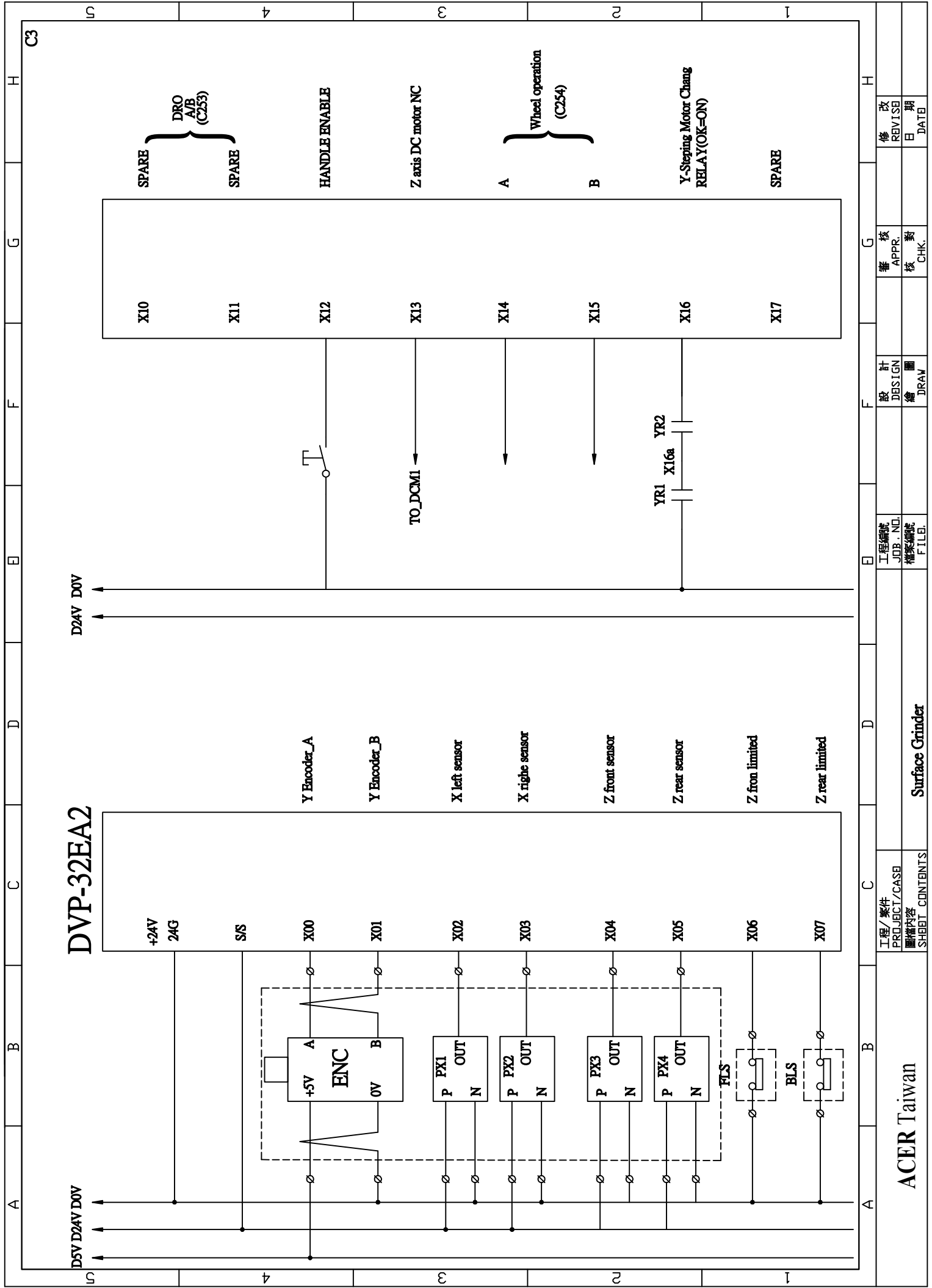
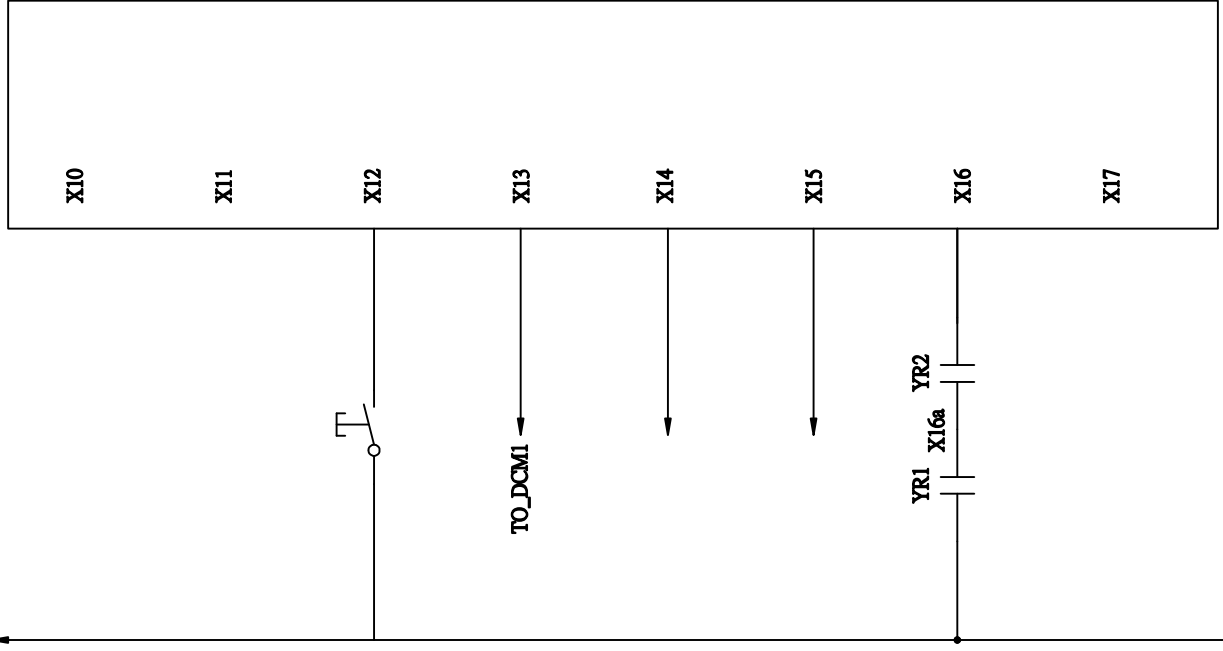
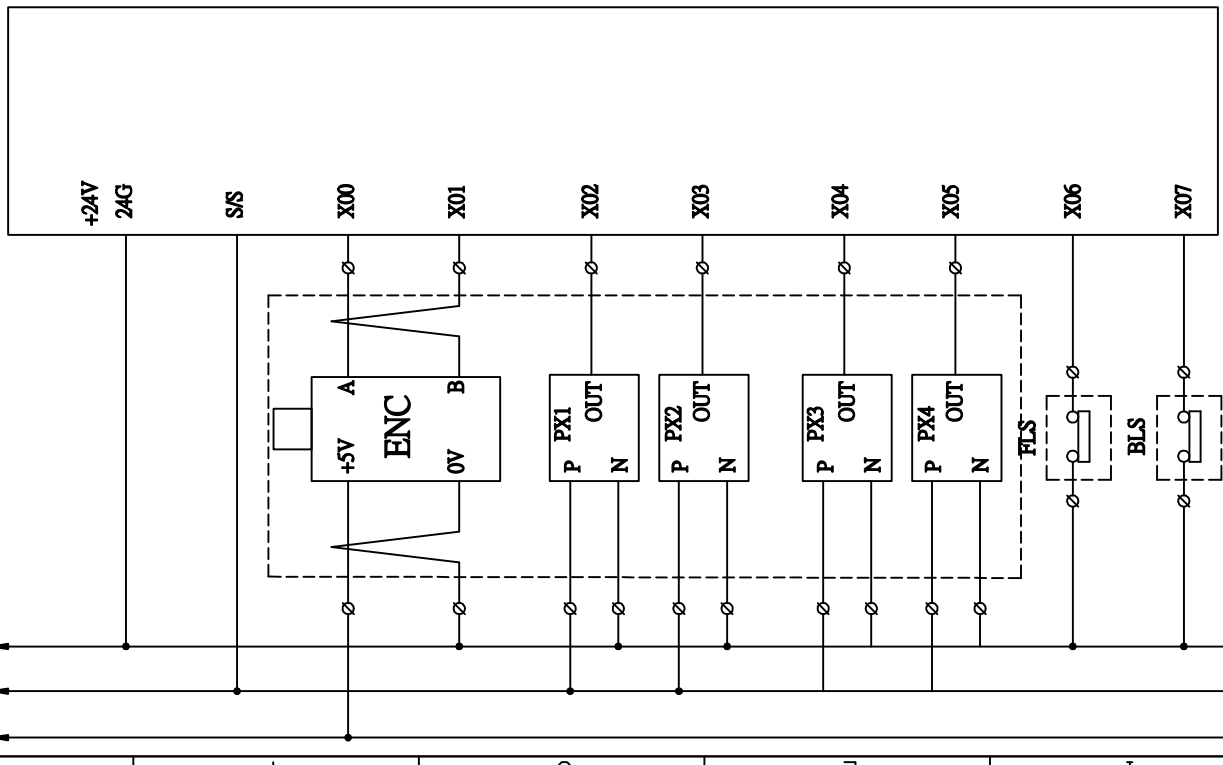

ACER Taiwan		Surface Grinder	
工程/案件 PROJECT/CASE	工程編號 JOB. NO.	設計 DESIGN	審核 CHK.
圖樣內容 SHBET. CONTENTS	圖樣編號 FILE.	繪圖 DRAW	校對 CHK.
		修改 REVISE	日期 DATE

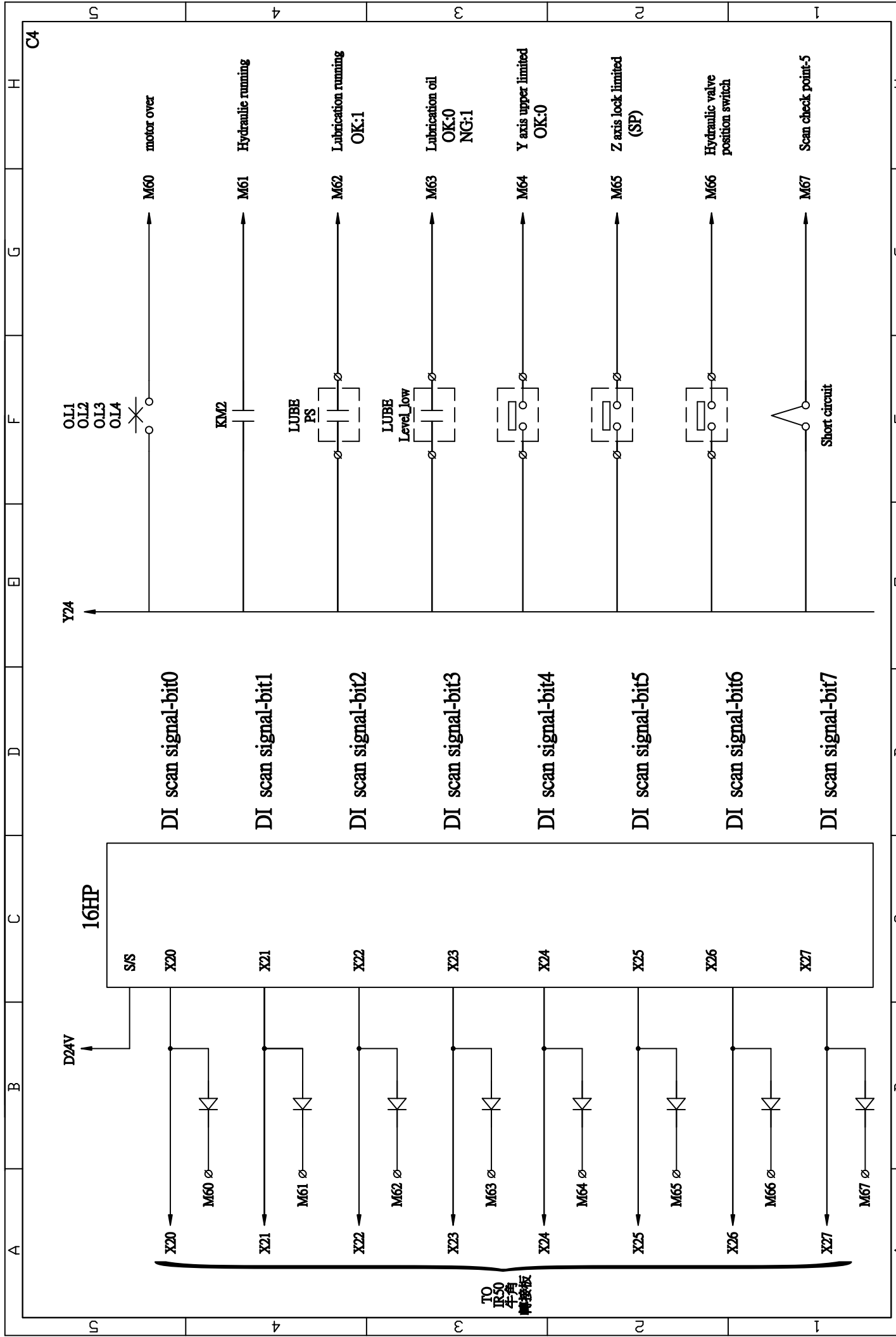

TO
IR50
牛角
轉接板

ACER Taiwan		Surface Grinder	
工程/案件 PROJECT/CASE	工程編號 JOB - NO.	設計 DESIGN	審核 CHK.
圖樣內容 SHEET - CONTENTS	檔案編號 FILEB.	繪圖 DRAW	校對 CHK.
		修改 REVISE	日期 DATE

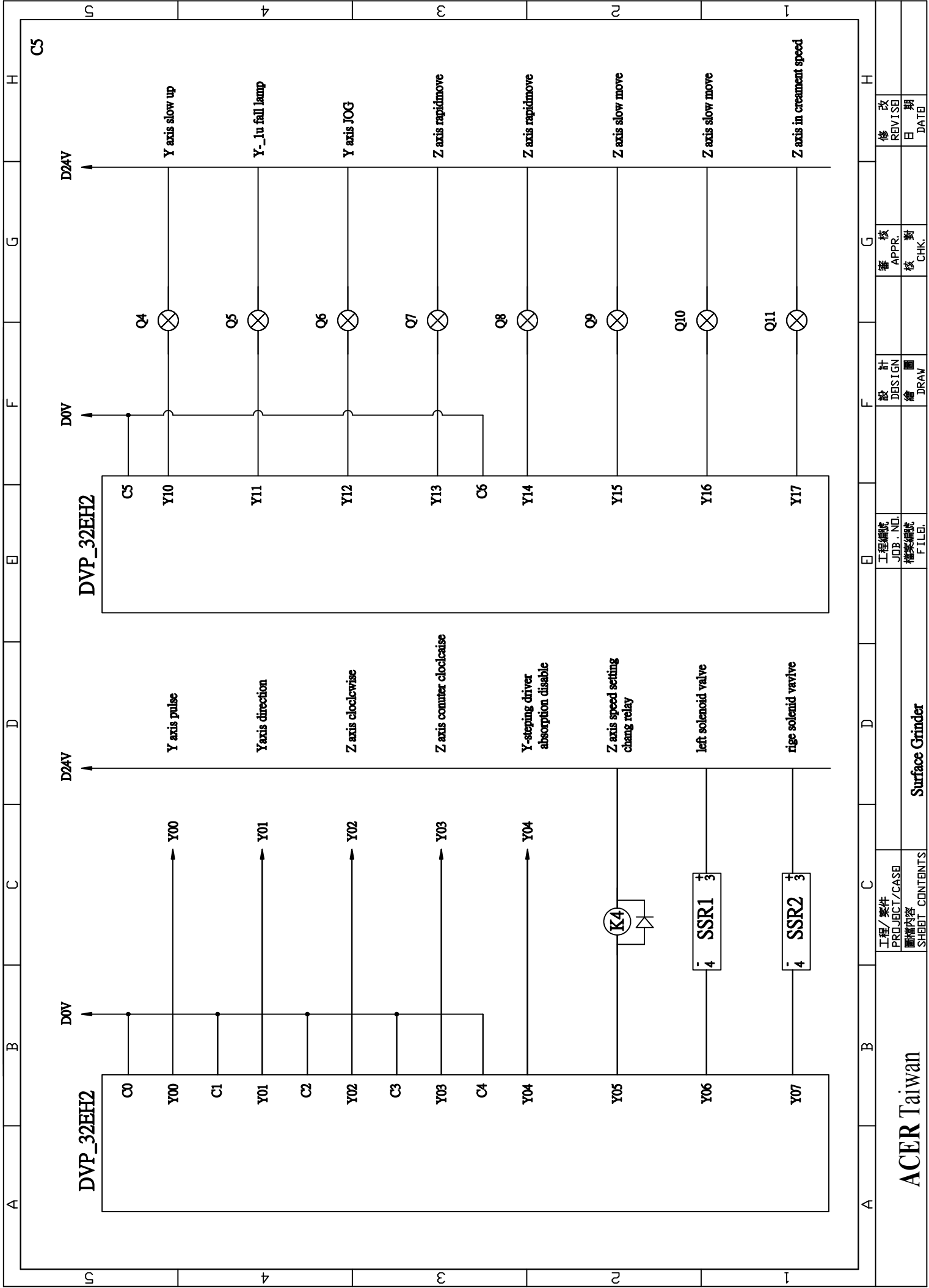

工程/案件 PROJECT/CASE		工程編號 JOB. NO.		審核		修改	
圖樣內容 SHEET CONTENTS		權號編號 FILE NO.		APPR. 核對		REVISION 日期	
ACER Taiwan		Surface Grinder		CHK. 核對		DATE	

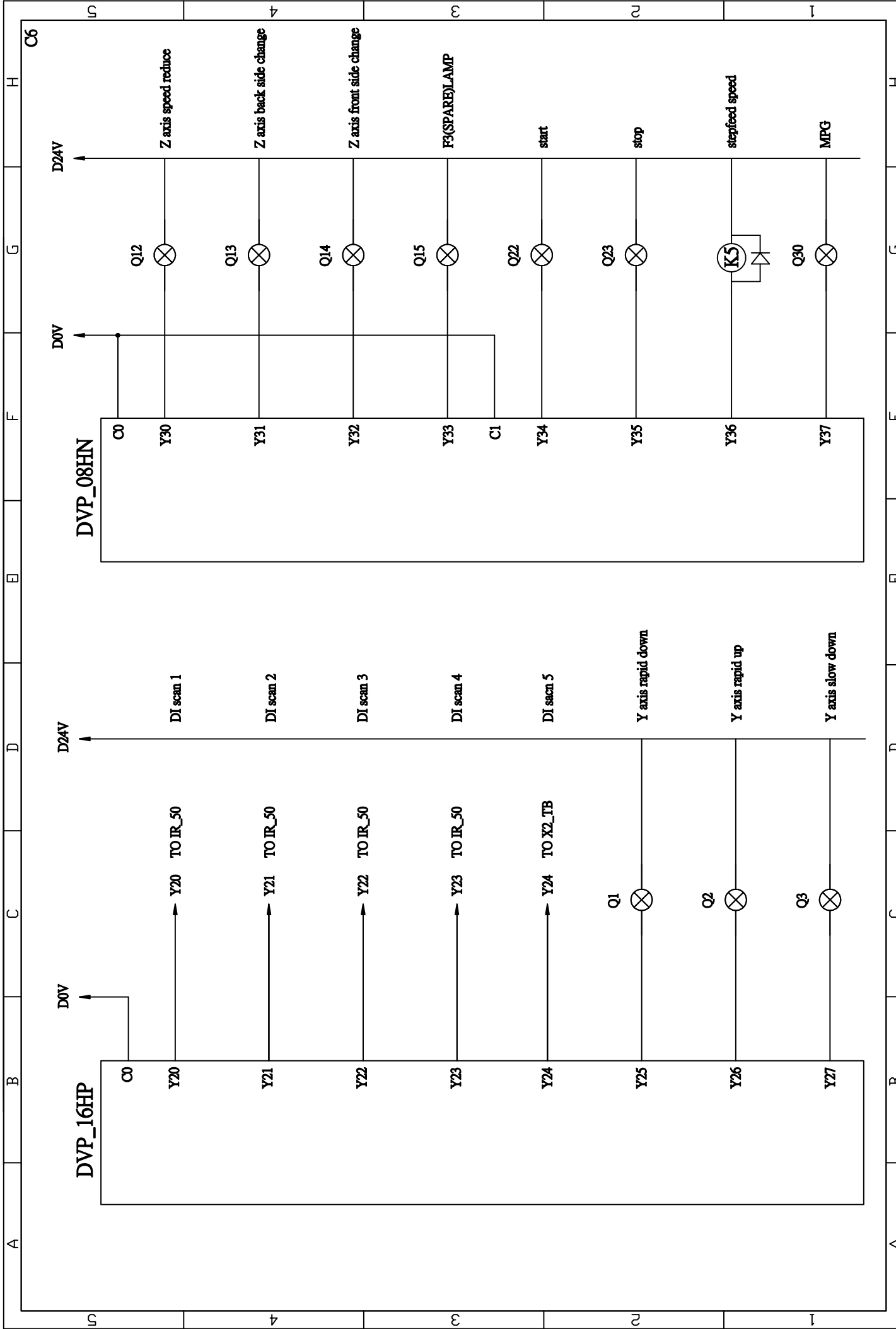

ACER Taiwan		Surface Grinder	
工程/案件 PROJECT/CASE	工程編號 JOB. NO.	設計 DESIGN	修改 REVISE
圖樣內容 SHEET CONTENTS	權責編號 FILEB.	繪圖 DRAW	日期 DATE
		審核 CHK.	

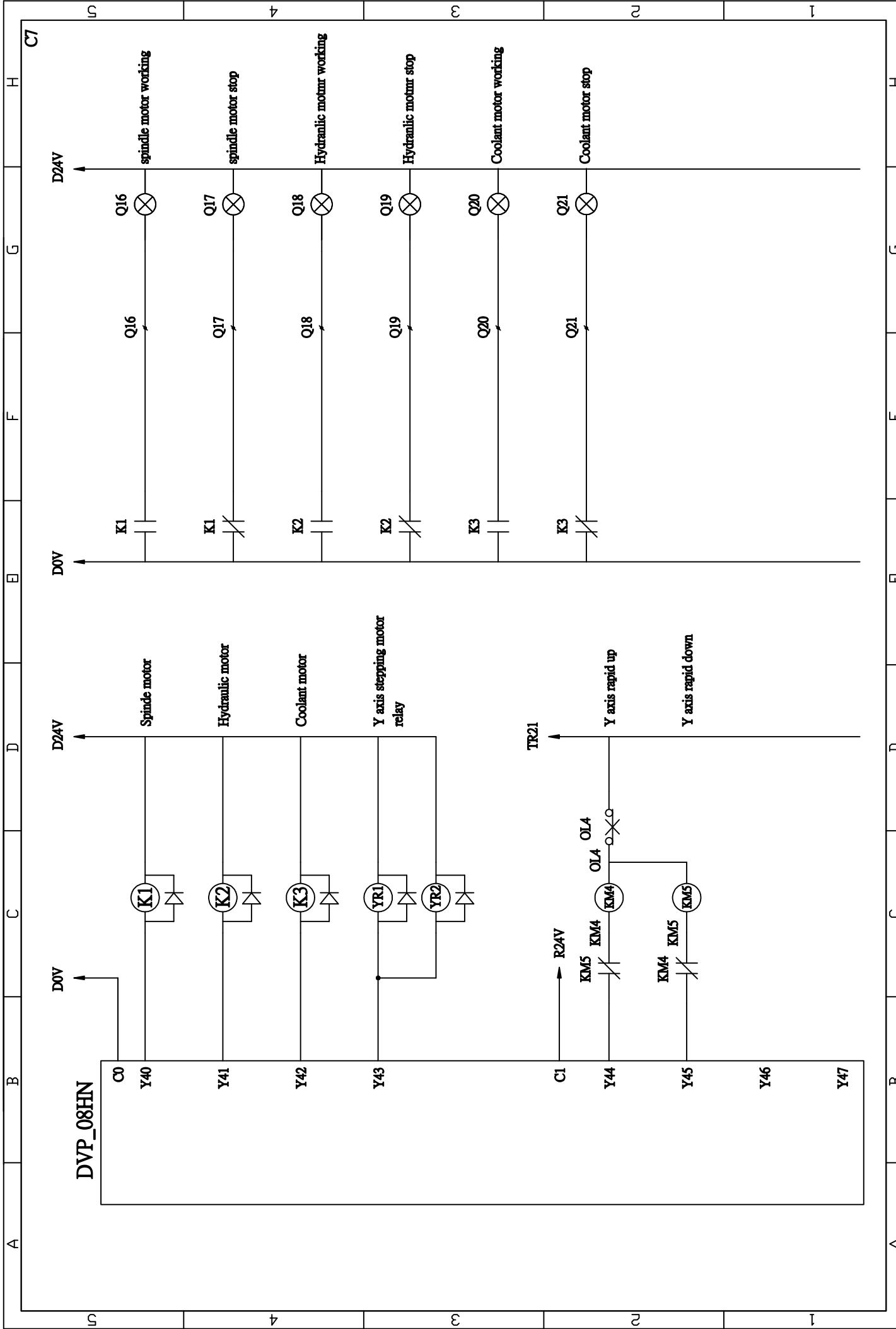

工程/案件 PROJECT/CASE		工程編號 JOB. NO.		設計 DESIGN		審核 APPR.		修改 REVISE	
圖樣內容 SHBET. CONTENTS		權責編號 FILB.		繪圖 DRAW		校對 CHK.		日期 DATE	
Surface Grinder									
ACER Taiwan									

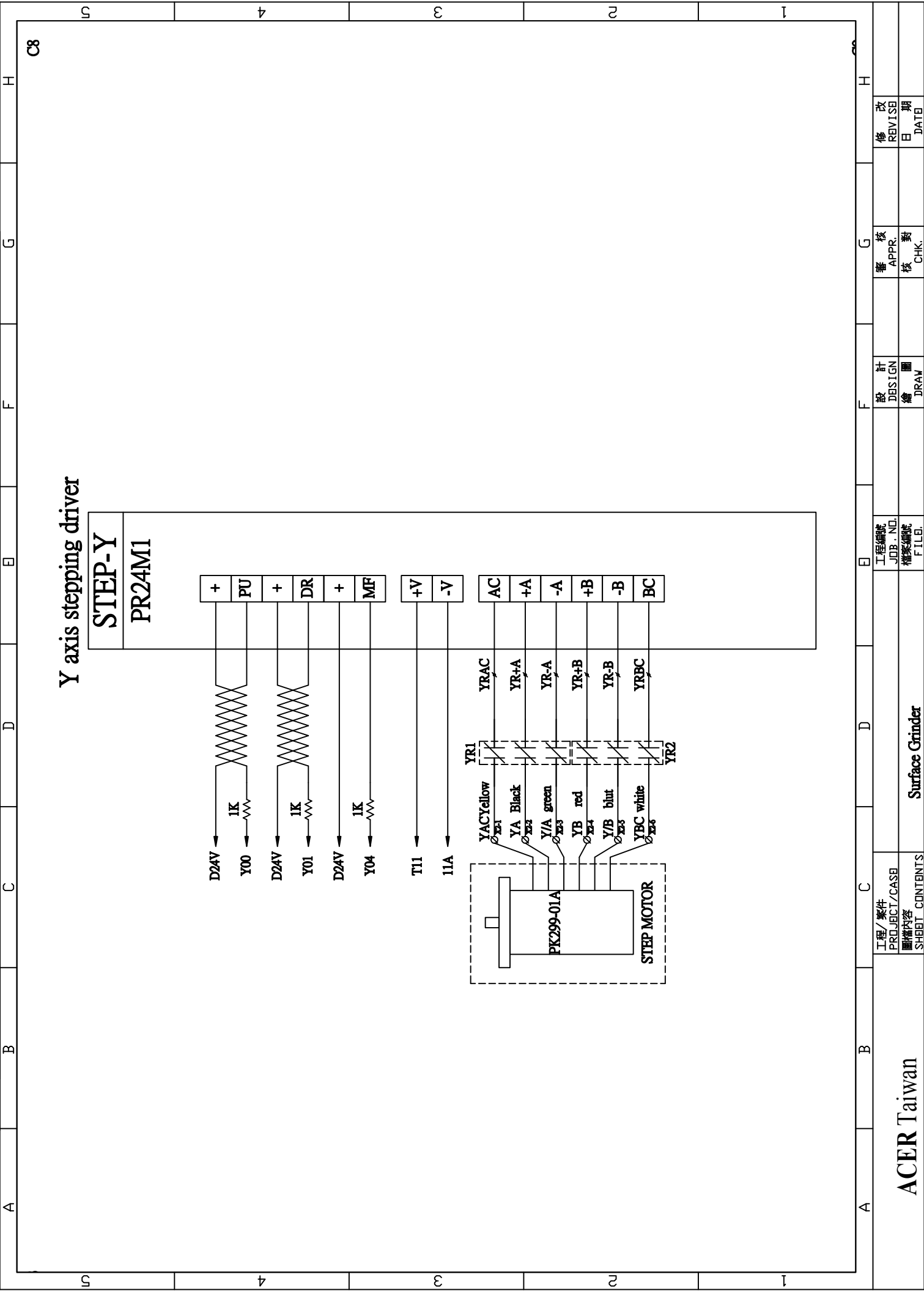

Y axis stepping driver

STEP-Y
PR24M1

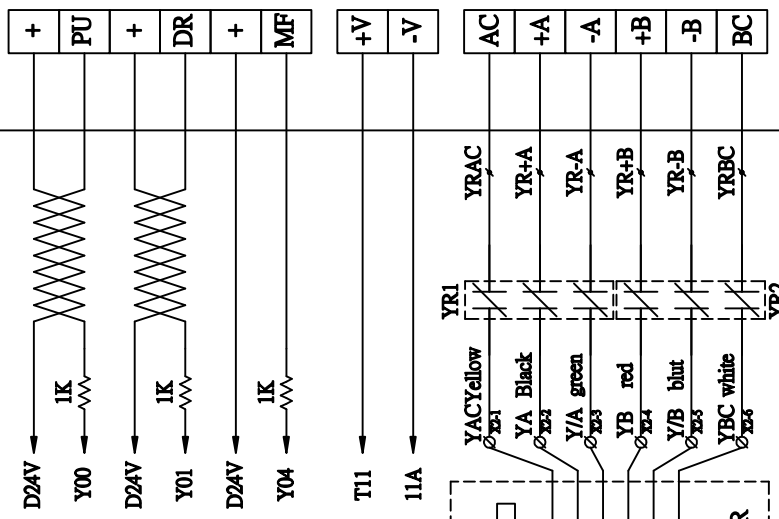

工程/案件 PROJECT/CASE		工程編號 JOB. NO.		設計 DESIGN		審核 APPR.		修改 REVISE	
圖樣內容 SHBET. CONTENTS		圖樣編號 FILB.		繪圖 DRAW		校對 CHK.		日期 DATE	
Surface Grinder									

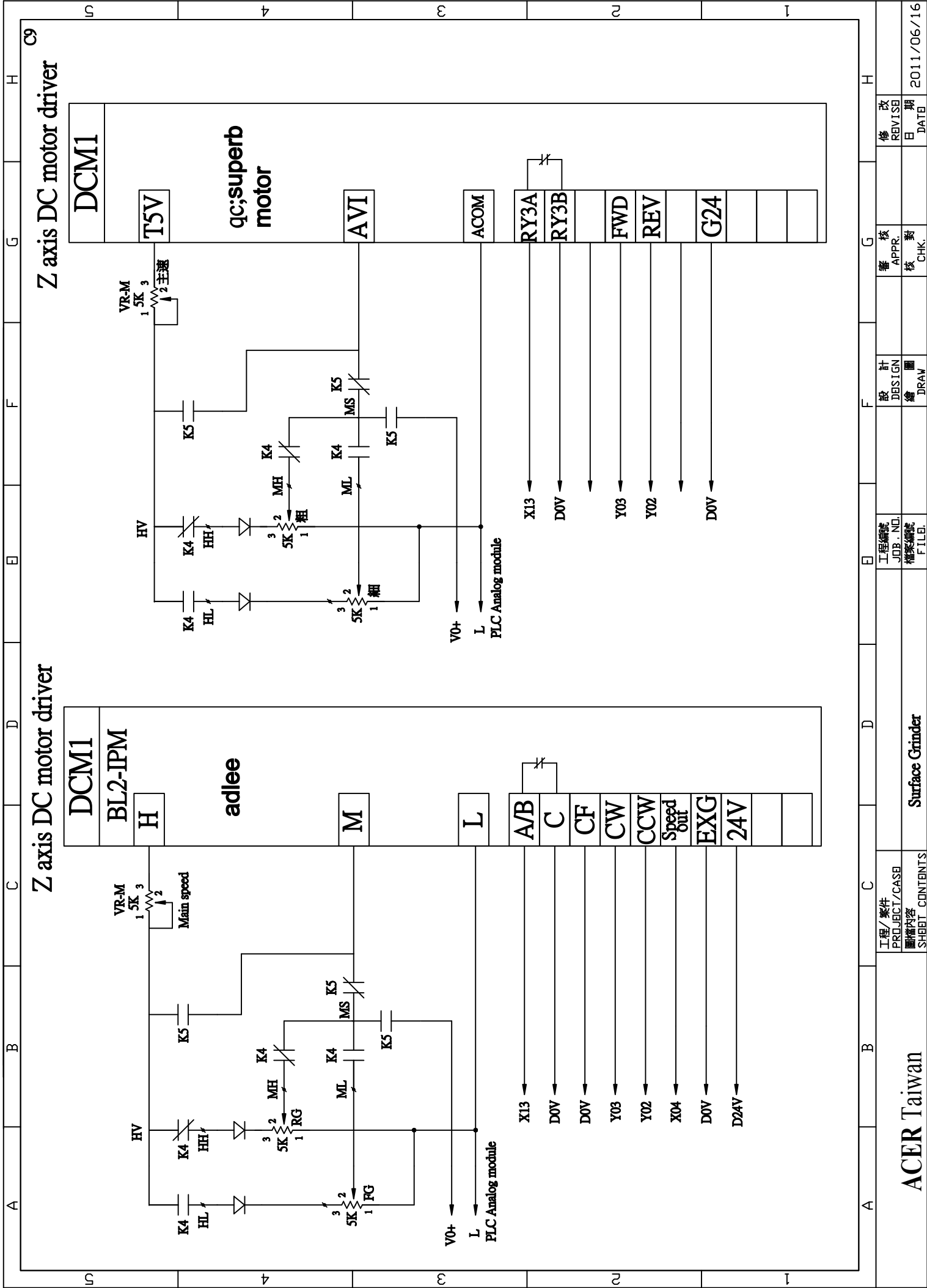

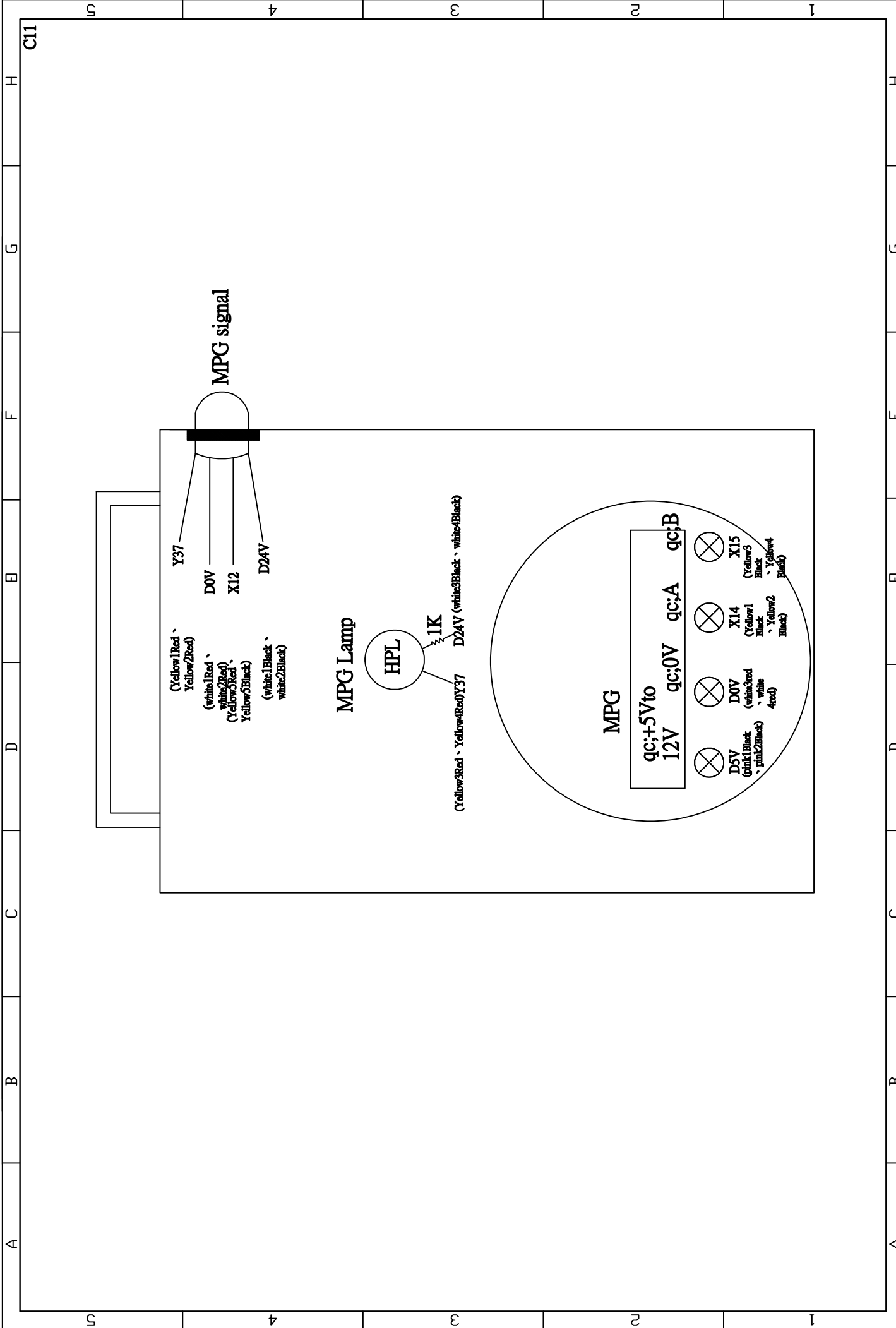

A		B		C		D		E		F		G		H	
ACER Taiwan															
工程/案件 PROJECT/CASE				圖樣內容 SHEET CONTENTS				Surface Grinder				工程編號 JOB. NO.			
												檔案編號 FILEB.			
												設計 DESIGN			
												繪圖 DRAW			
												審核 APPR.			
												校對 CHK.			
												修改 REVISE			
												日期 DATE			
												2011/06/16			