

Machine Model	Designaion Standard	Title Paeg	ACER		
	FAGOR 8055I CNC	power-1	Date: 2012/8/28	Ref:	
					Page 1
					Page 31

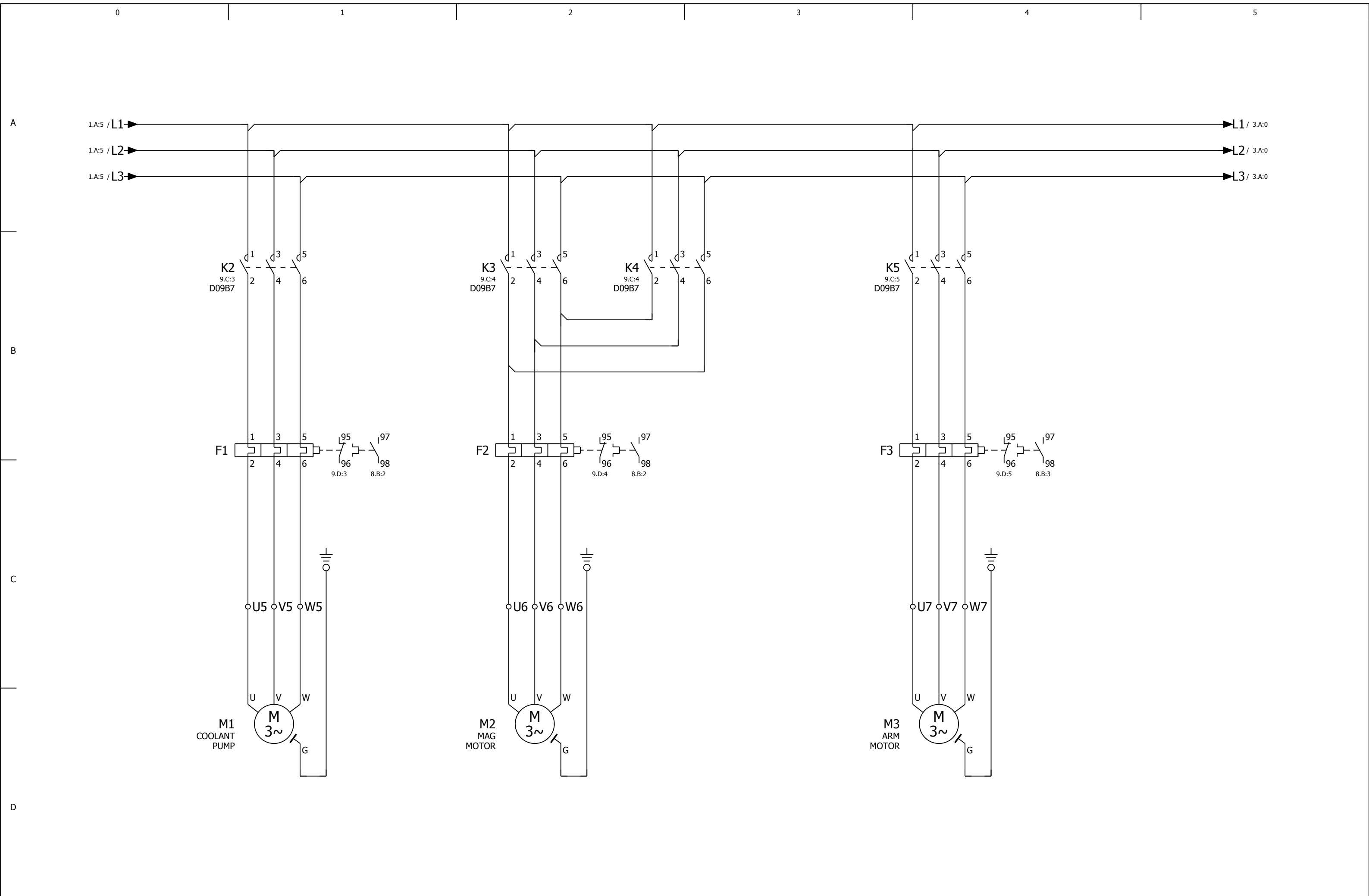

Machine Model	Designaion Standard	Title Paeg	ACER
FAGOR 8055I CNC		power-2	Date: 2011/8/25 Ref:

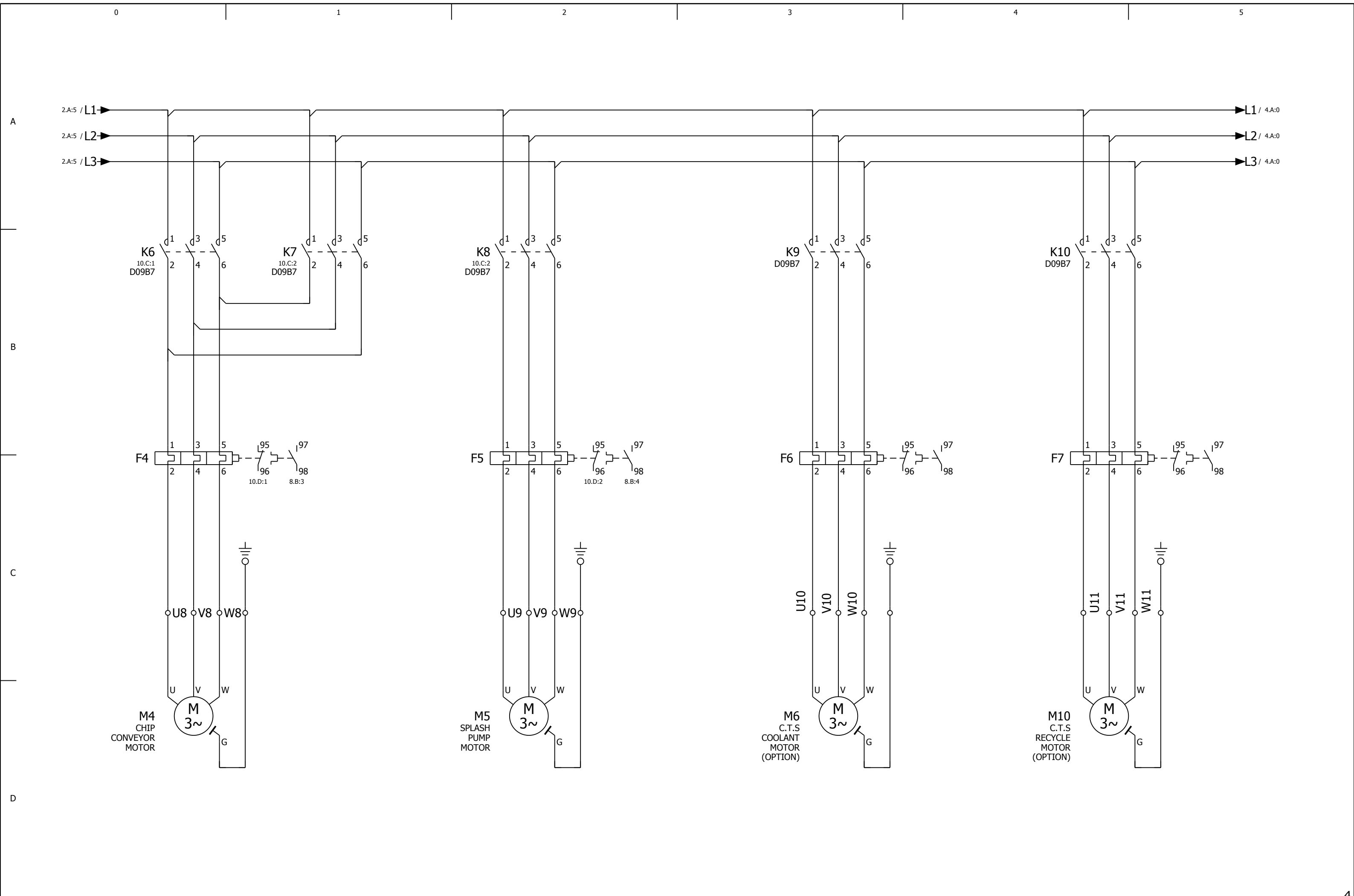

Machine Model	Designaion Standard	Title Paeg	ACER		
	FAGOR 8055I CNC	power-3	Date: 2011/8/25	Ref:	
					Page 3
					Page 31

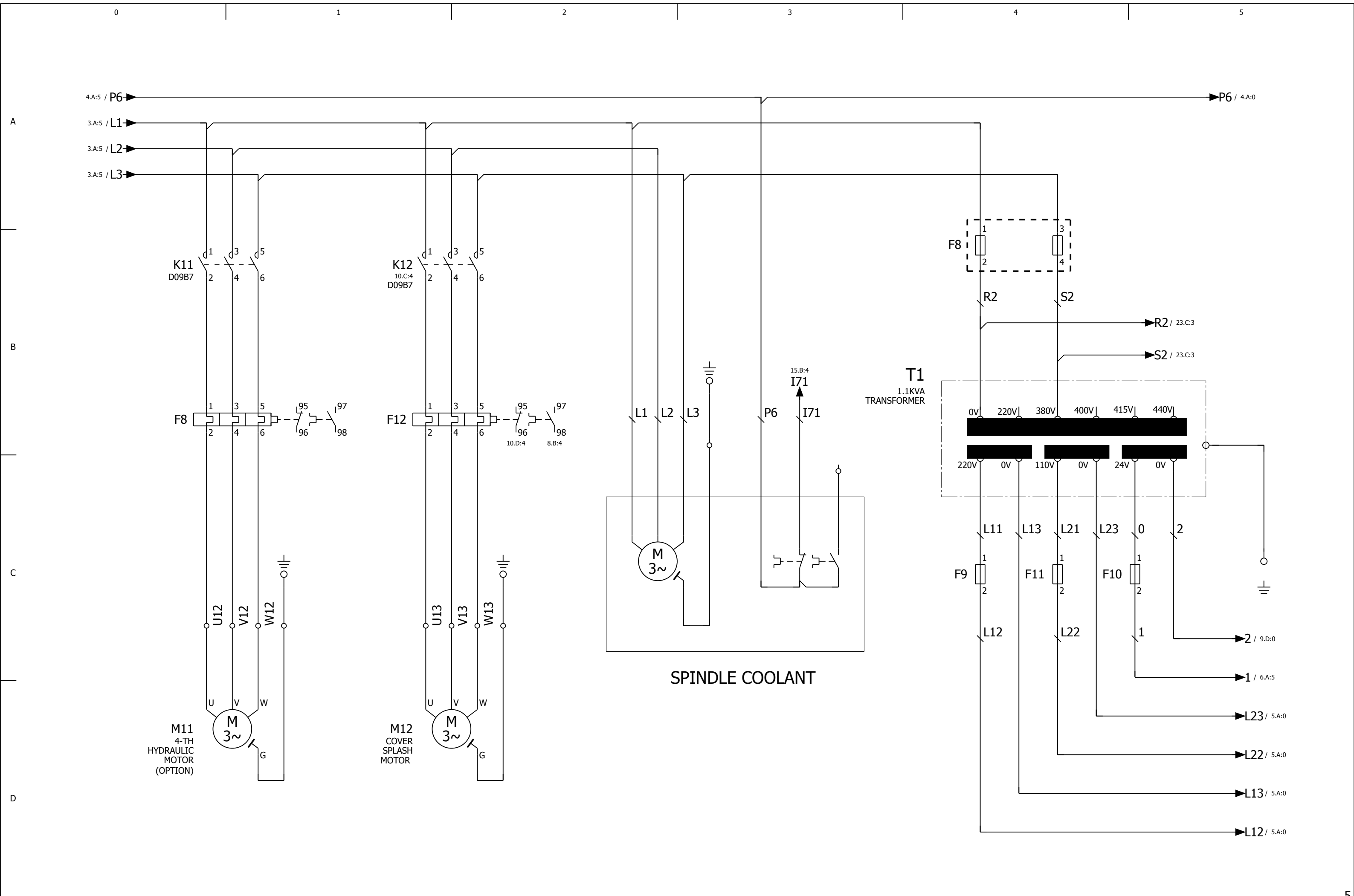

Machine Model	Designaion Standard	Title Paeg	ACER		
FAGOR 8055I CNC		power-4	Date: 2012/8/28	Ref:	Page 4
					Page 31

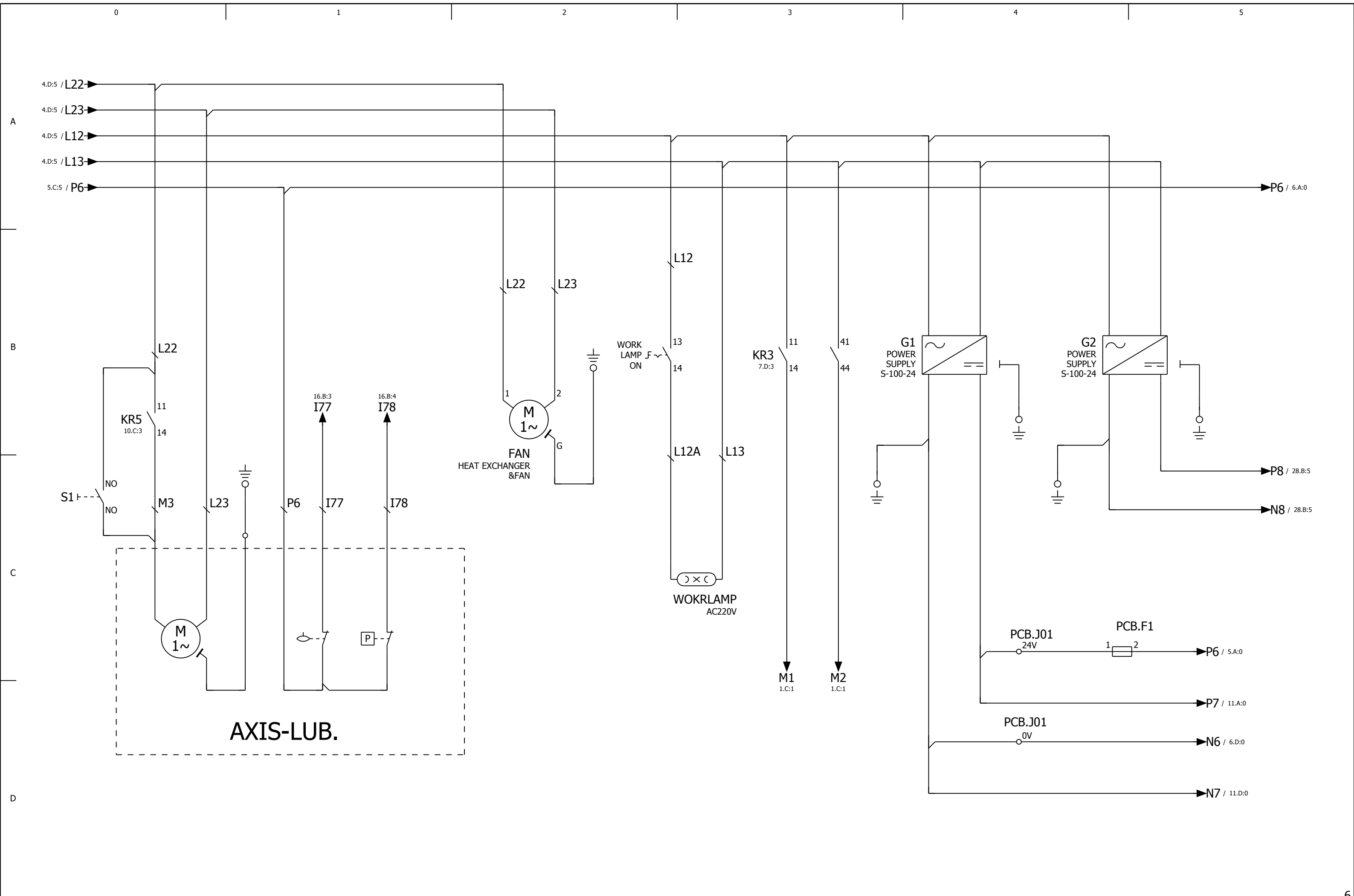

AXIS-LUB.

Machine Model	Designaion Standard	Title Paeg	ACER				
FAGOR 8055I CNC	power-5	Date: 2012/8/28	Ref:				
			<table border="1" style="border-collapse: collapse;"> <tr> <td style="width: 50px;">Page</td> <td style="text-align: center;">5</td> </tr> <tr> <td>Page</td> <td style="text-align: center;">31</td> </tr> </table>	Page	5	Page	31
Page	5						
Page	31						

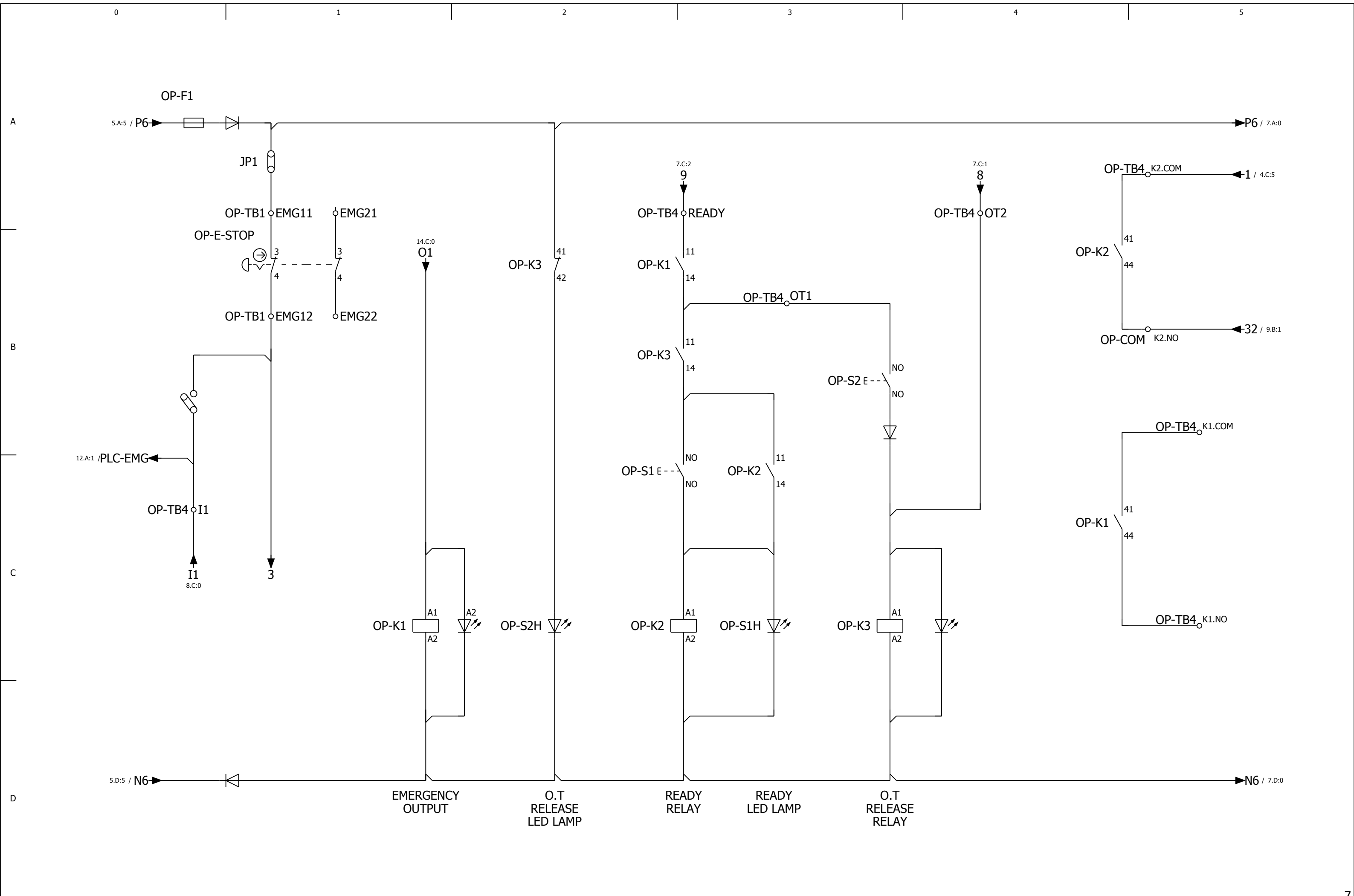

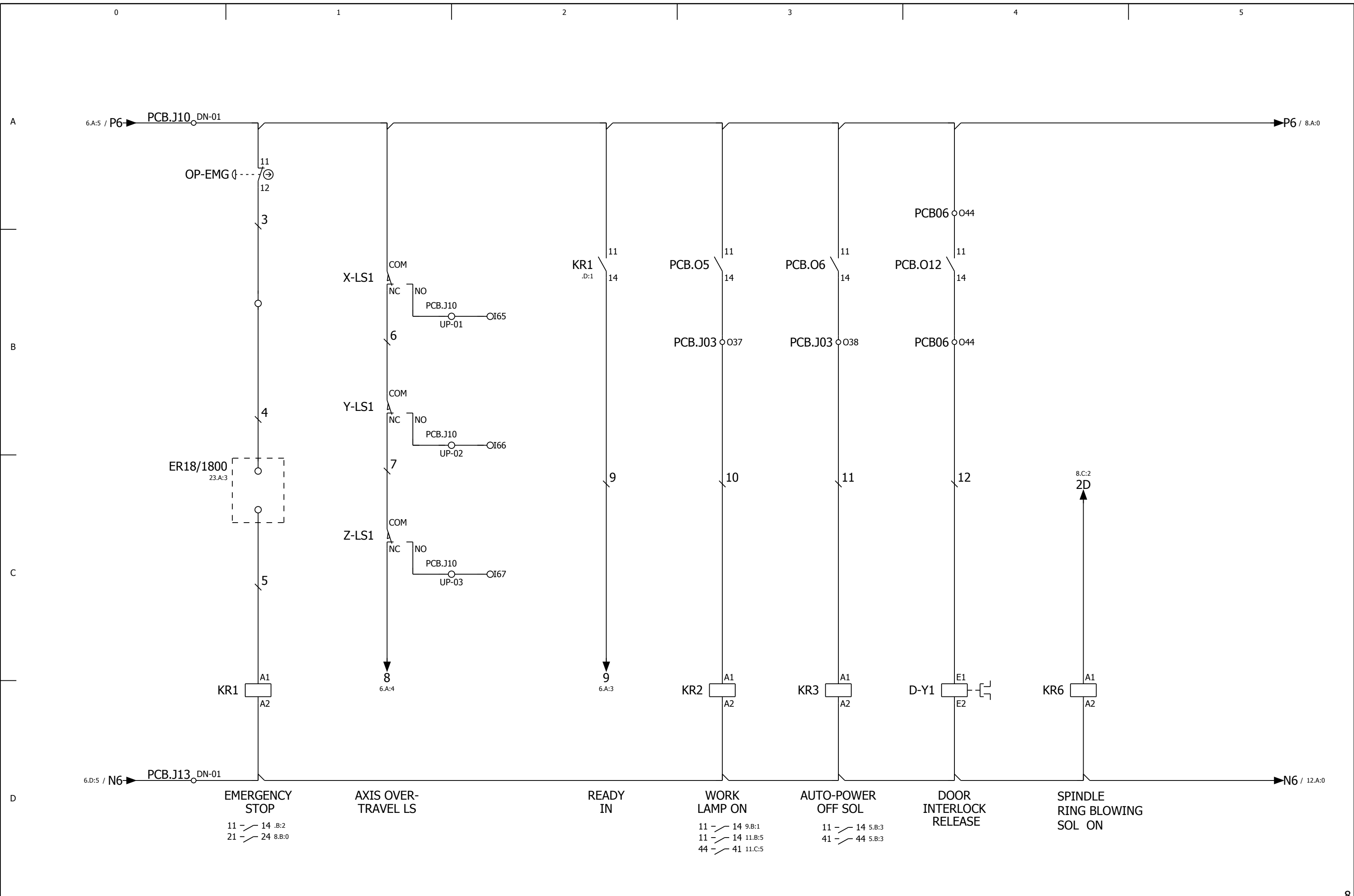

6

8

Machine Model	Designaion Standard	Title Paeg	ACER		
	FAGOR 8055I CNC	CNC CONTROL UNIT(DC)-1	Date: 2012/8/28	Ref:	Page 7
					Page 31

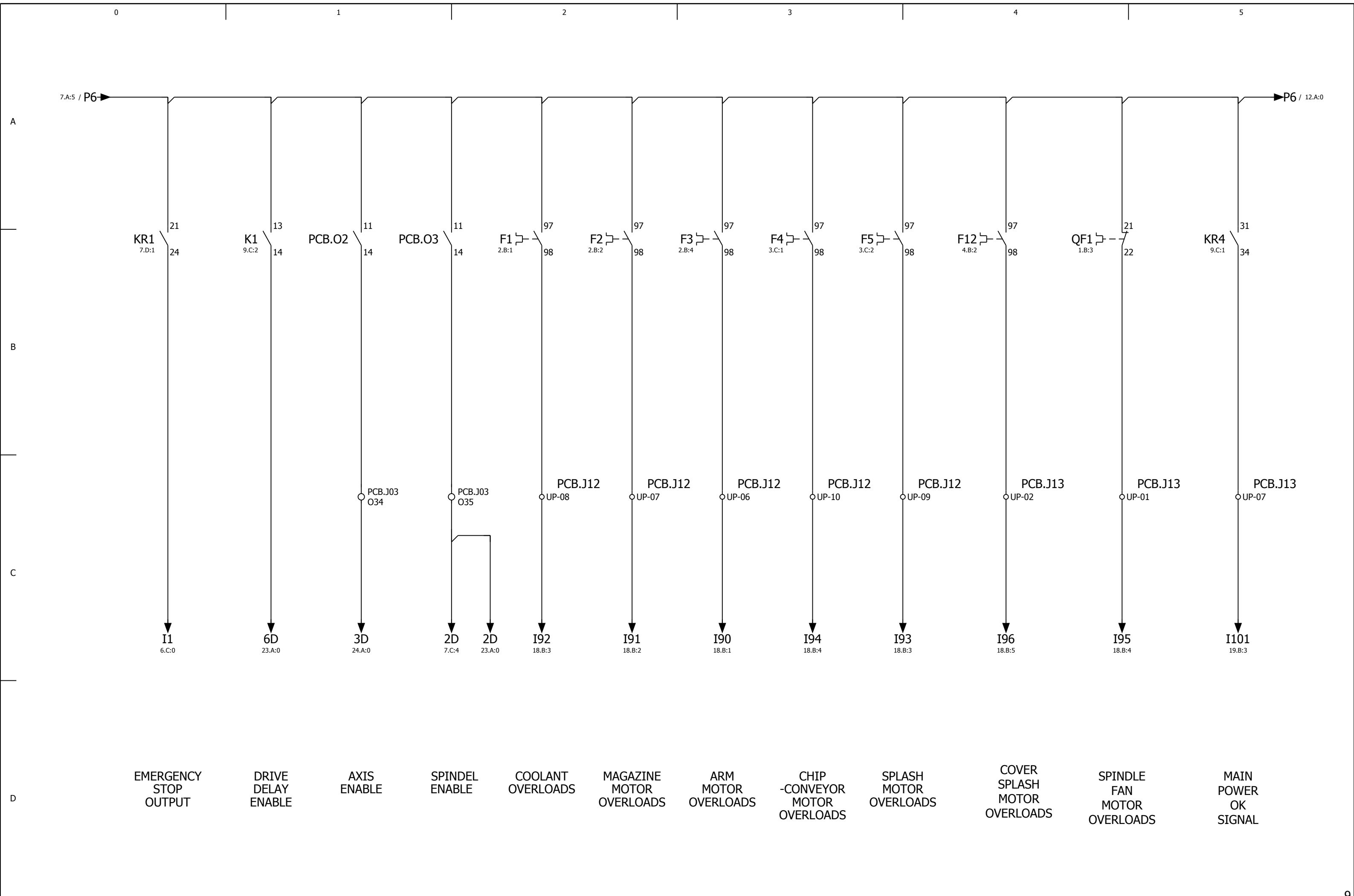

EMERGENCY STOP OUTPUT DRIVE DELAY ENABLE AXIS ENABLE SPINDEL ENABLE COOLANT OVERLOADS MAGAZINE MOTOR OVERLOADS ARM MOTOR OVERLOADS CHIP -CONVEYOR MOTOR OVERLOADS SPLASH MOTOR OVERLOADS COVER SPLASH MOTOR OVERLOADS SPINDLE FAN MOTOR OVERLOADS MAIN POWER OK SIGNAL

Machine Model	Designaion Standard	Title Paeg	ACER
	FAGOR 8055I CNC	CNC CONTROL UNIT(DC)-2	=
			+
		Date: 2012/8/28	Ref:
			Page 8 Page 31

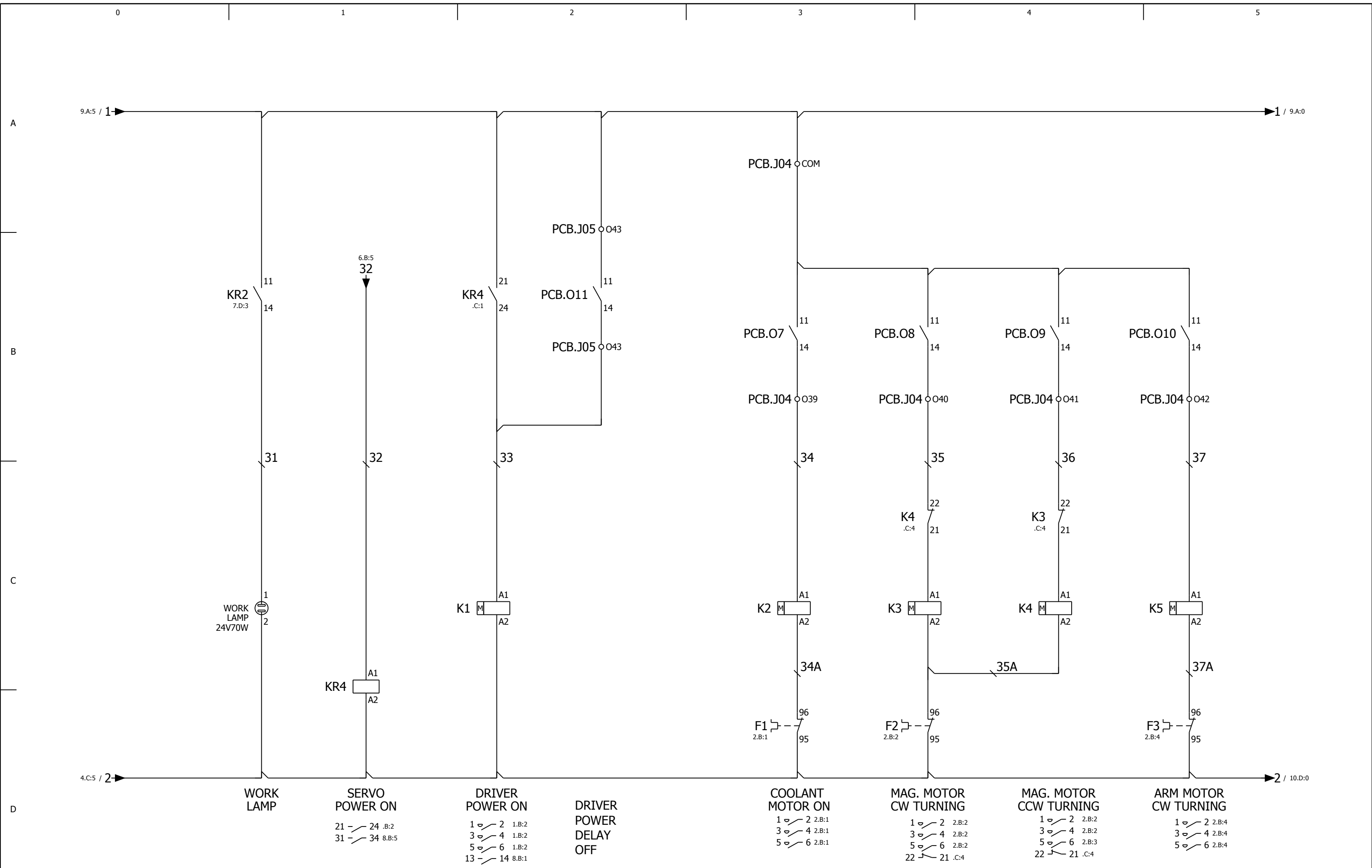

9.A:5 / 1 → 1 / 9.A:0

4.C:5 / 2 → 2 / 10.D:0

Machine Model	Designaion Standard	Title Paeg	ACER		
FAGOR 8055I CNC		CNC COMTROL UNIT(AC)-1	Date: 2011/8/25	Ref:	
					Page 9
					Page 31

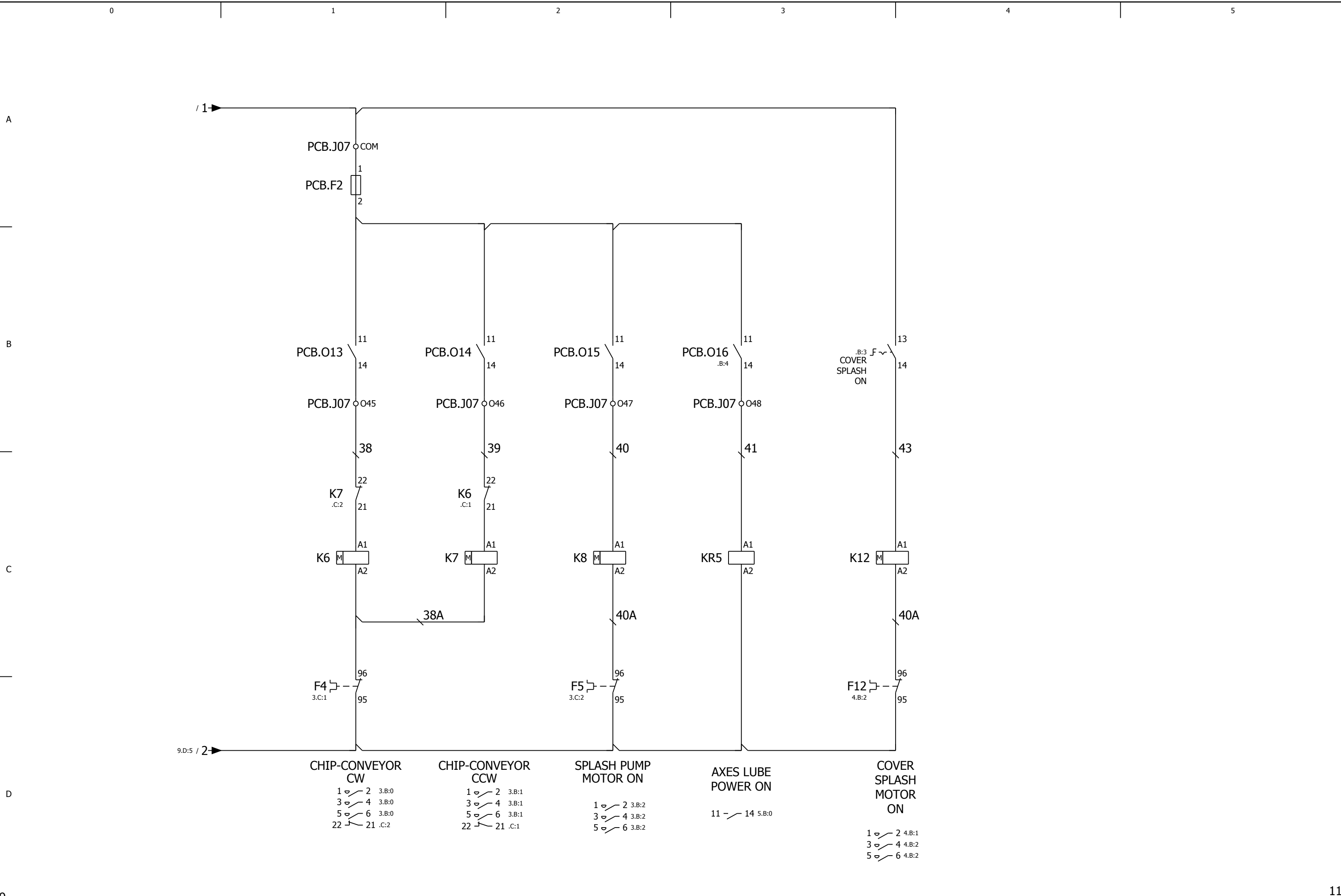

Machine Model	Designaion Standard	Title Paeg	ACER		
	FAGOR 8055I CNC	CNC CONTROL UNIT(AC)-2	Date: 2011/8/25	Ref:	
					Page 10 Page 31

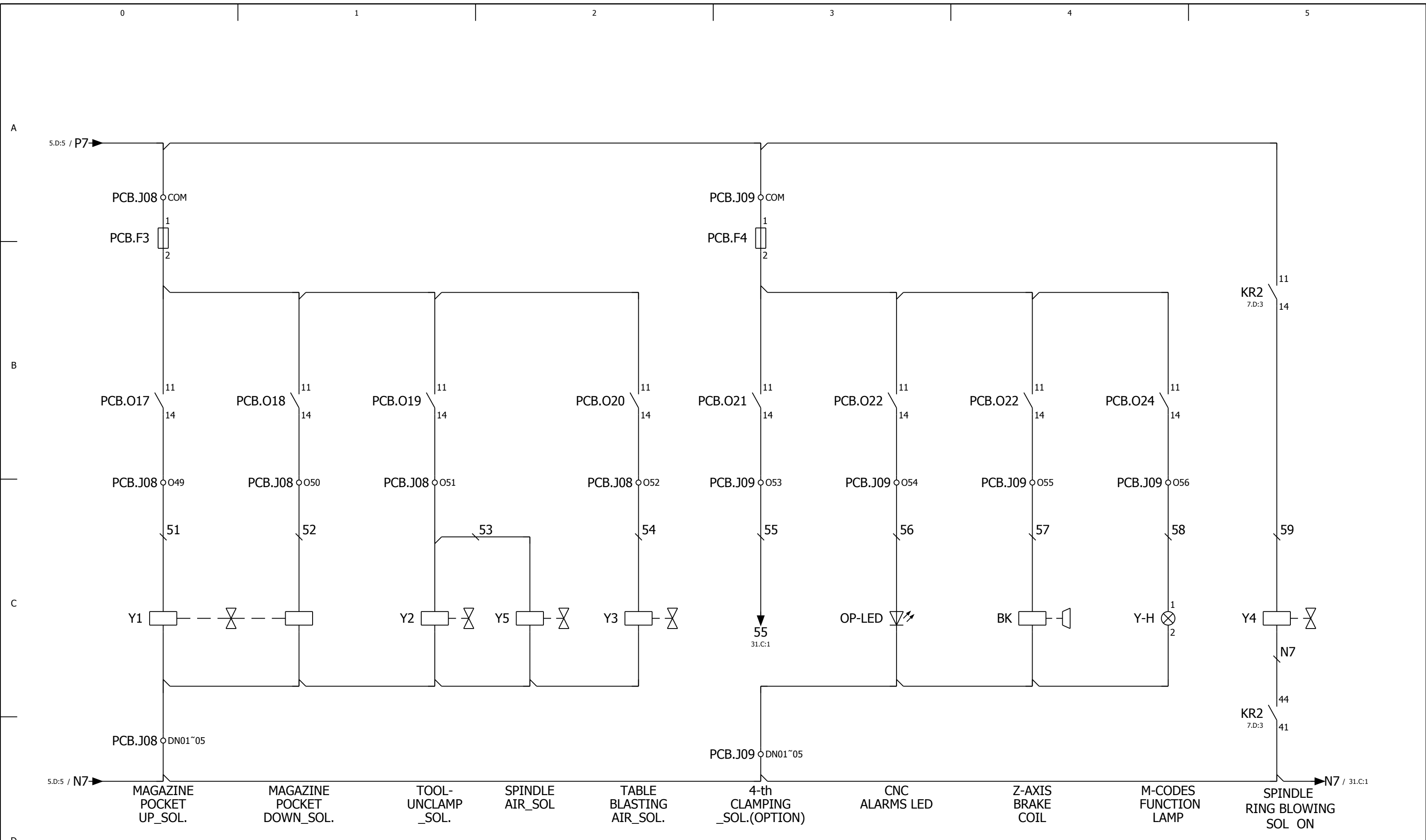

Machine Model	Designaion Standard	Title Paeg	ACER
FAGOR 8055I CNC	CNC COMTROL UNIT(SOL)-1	Date: 2012/8/28	Ref:

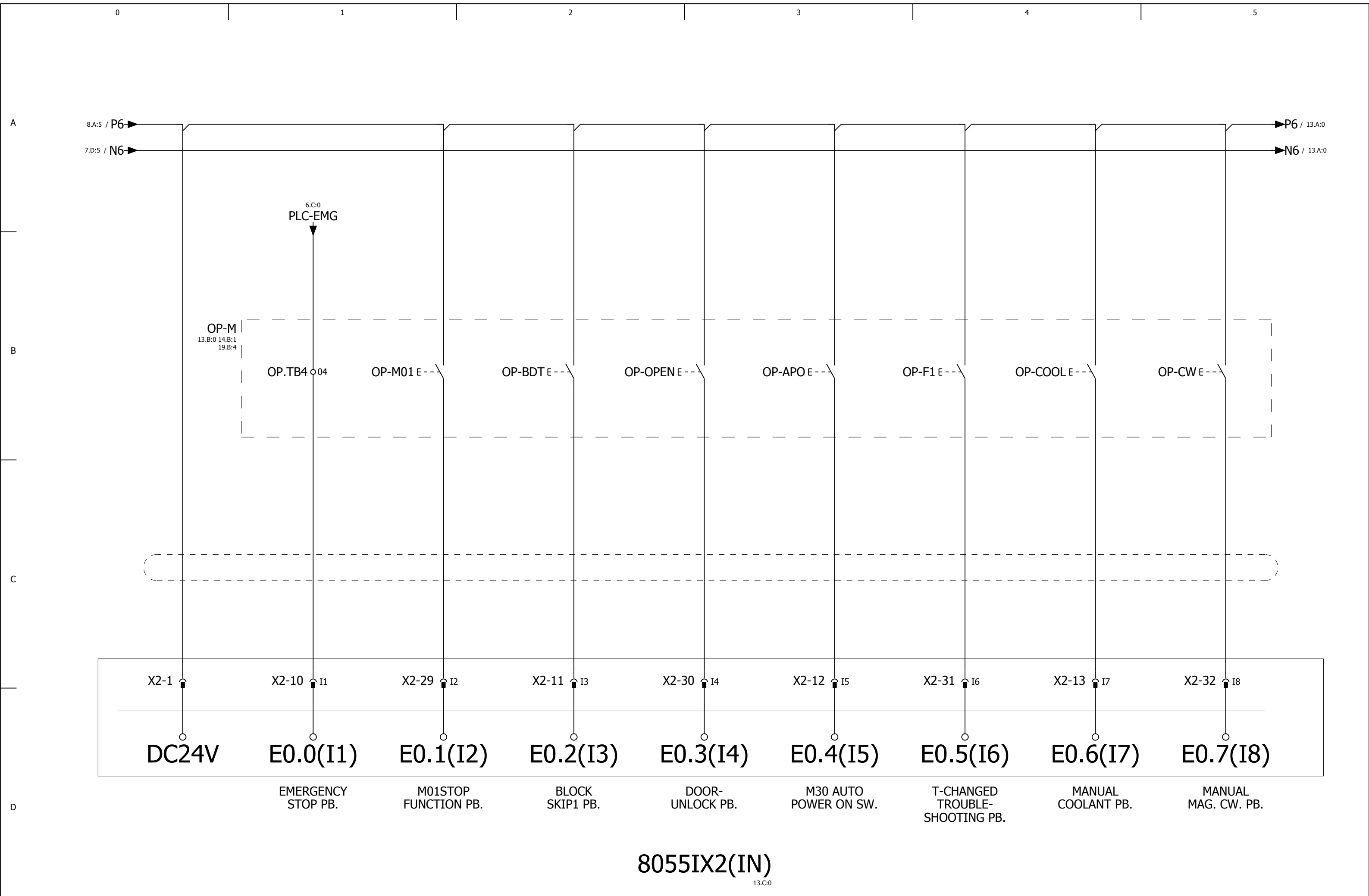

8055IX2(IN)
13.C:0

Machine Model	Designaion Standard	Title Paeg	ACER	
FAGOR 8055I CNC	CNC COMTROL UNIT X2-IN-1	Date: 2012/8/28	Ref:	
				Page 12
				Page 31

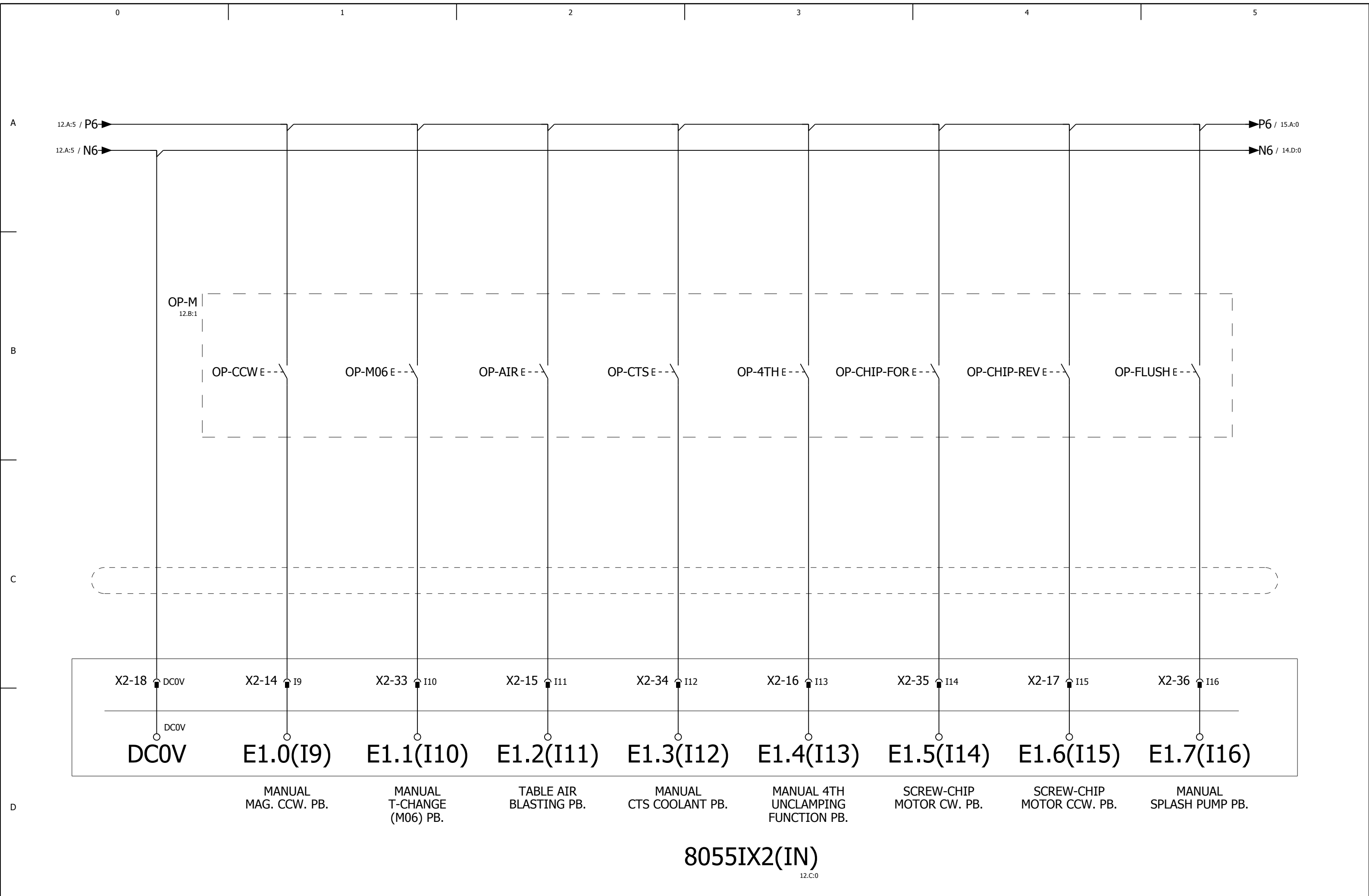

8055IX2(IN)

12.C:0

Machine Model	Designaion Standard	Title Paeg	ACER	
FAGOR 8055I CNC	CNC COMTRON UNIT X2-IN-2	Date: 2012/8/28	Ref:	
				Page 13
				Page 31

8055IX2(OUT)

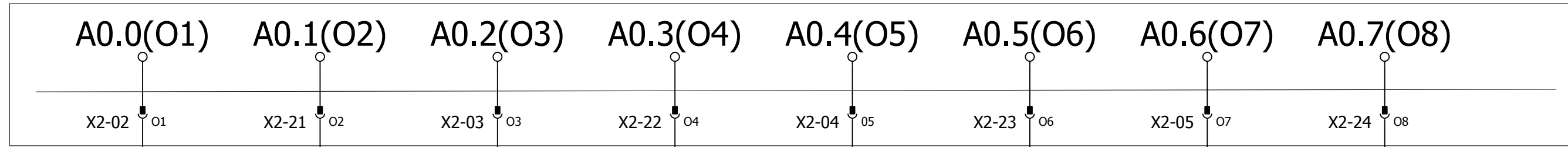

OP-M
12.B:1

OP-LED



O1
6.B:1

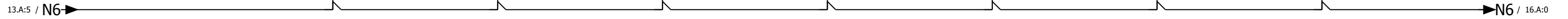

EMERGENCY STOP PB.

X-AXIS HOME LED

Y-AXIS HOME LED

Z-AXIS HOME LED

AXD LUBE. ALARMS LED

M01STOP FUNCTION LED

BLOCK SKIP FUNCTION LED

M30 AUTO POWER-OFF FUNCTION LED

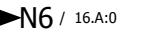

Machine Model	Designaion Standard	Title Paeg	ACER	=
FAGOR 8055I CNC	CNC CONTROL UNIT X2-OUT-1	Date: 2012/8/28	Ref:	+
				Page 14
				Page 31

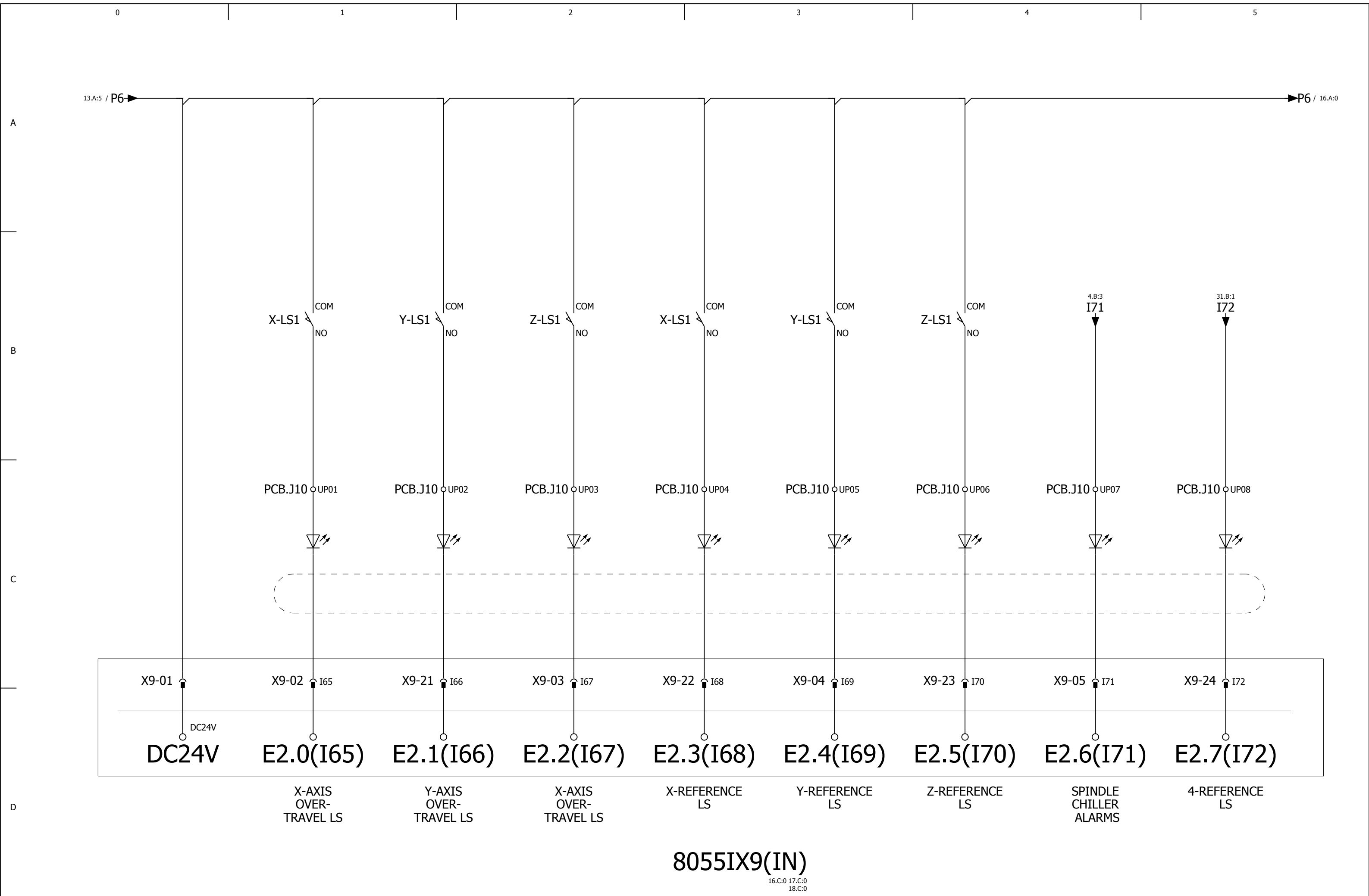

8055IX9(IN)
16.C:0 17.C:0
18.C:0

Machine Model	Designaion Standard	Title Paeg	ACER				
FAGOR 8055I CNC	CNC COMTROL UNIT IN-1	Date: 2012/8/28	Ref:				
			<table border="1" style="float: right; border-collapse: collapse;"> <tr><td style="text-align: center;">=</td></tr> <tr><td style="text-align: center;">+</td></tr> </table>	=	+		
=							
+							
			<table border="1" style="float: right; border-collapse: collapse;"> <tr><td style="text-align: center;">Page</td><td style="text-align: center;">15</td></tr> <tr><td style="text-align: center;">Page</td><td style="text-align: center;">31</td></tr> </table>	Page	15	Page	31
Page	15						
Page	31						

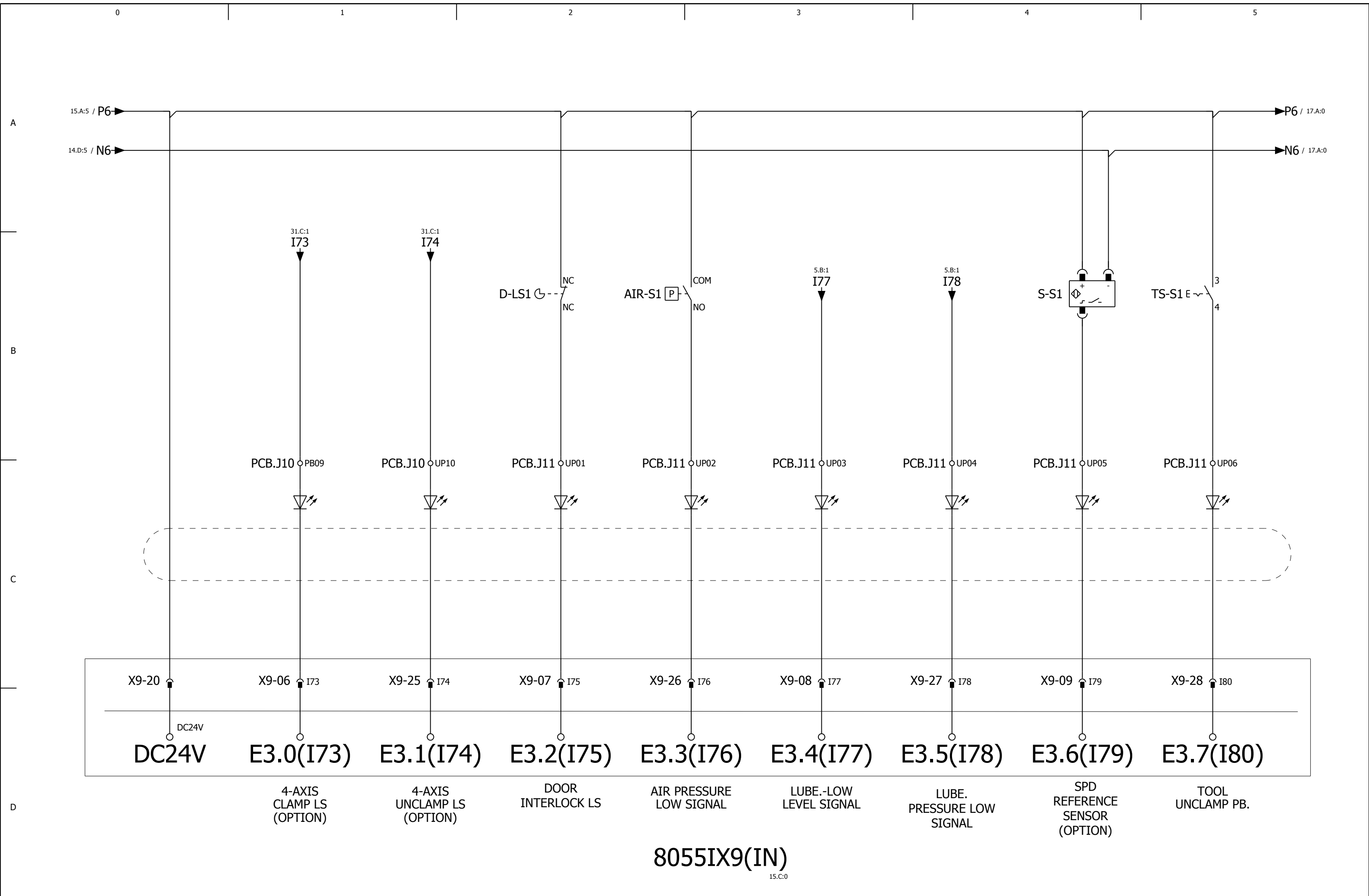

8055IX9(IN)
15.C:0

Machine Model	Designaion Standard	Title Paeg	ACER		
FAGOR 8055I CNC	CNC COMTROL UNIT IN-2		Date: 2012/8/28	Ref:	Page 16 Page 31

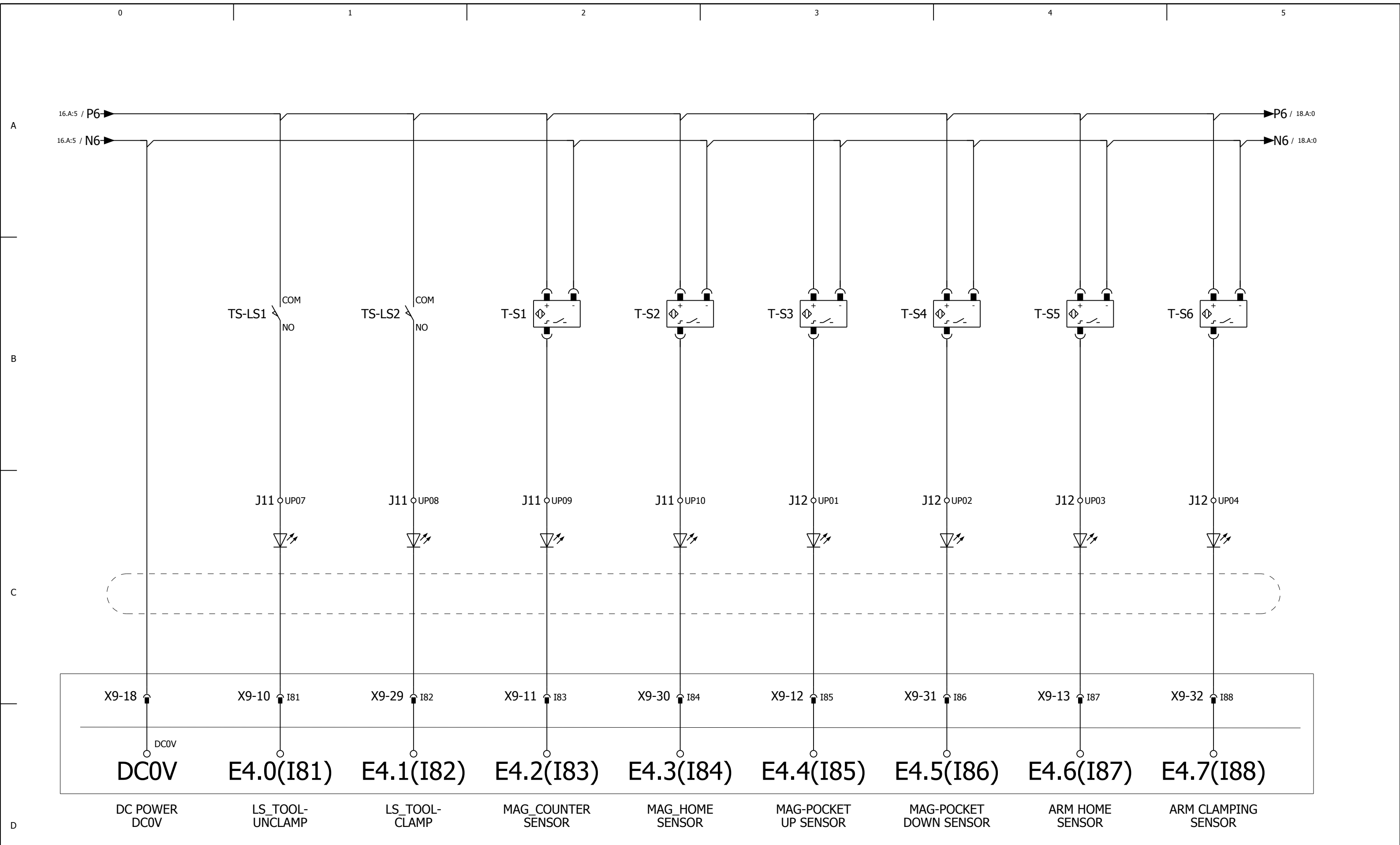

8055IX9(IN)
15.C:0

Machine Model	Designaion Standard	Title Paeg	ACER	=
FAGOR 8055I CNC	CNC COMTROL UNIT IN-3			+
		Date: 2012/8/28	Ref:	Page 17
				Page 31

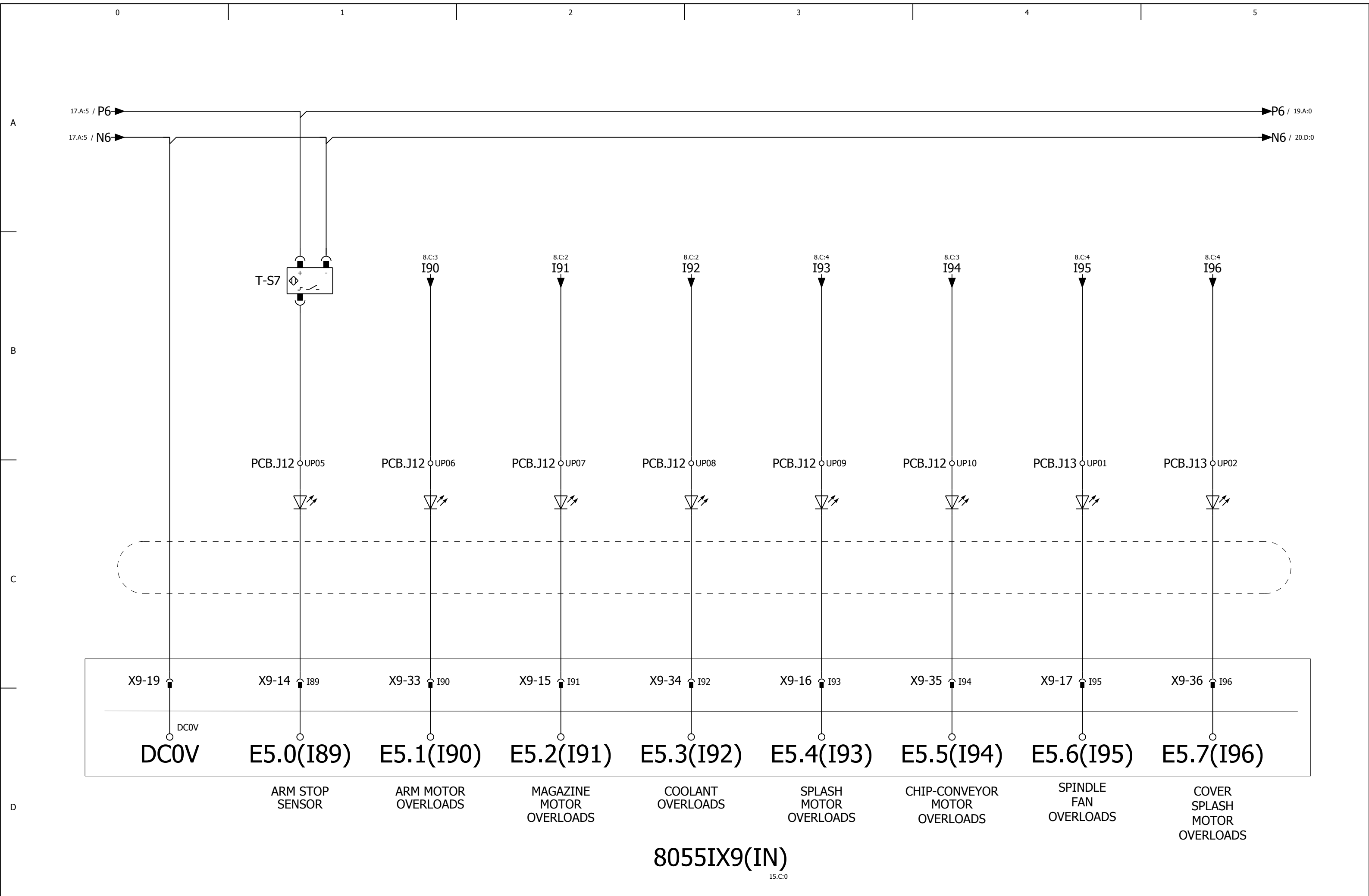

8055IX9(IN)
15.C:0

Machine Model	Designaion Standard	Title Paeg	ACER	=
FAGOR 8055I CNC	CNC COMTROL UNIT IN-4	Date: 2012/8/28	Ref:	+
				Page 18
				Page 31

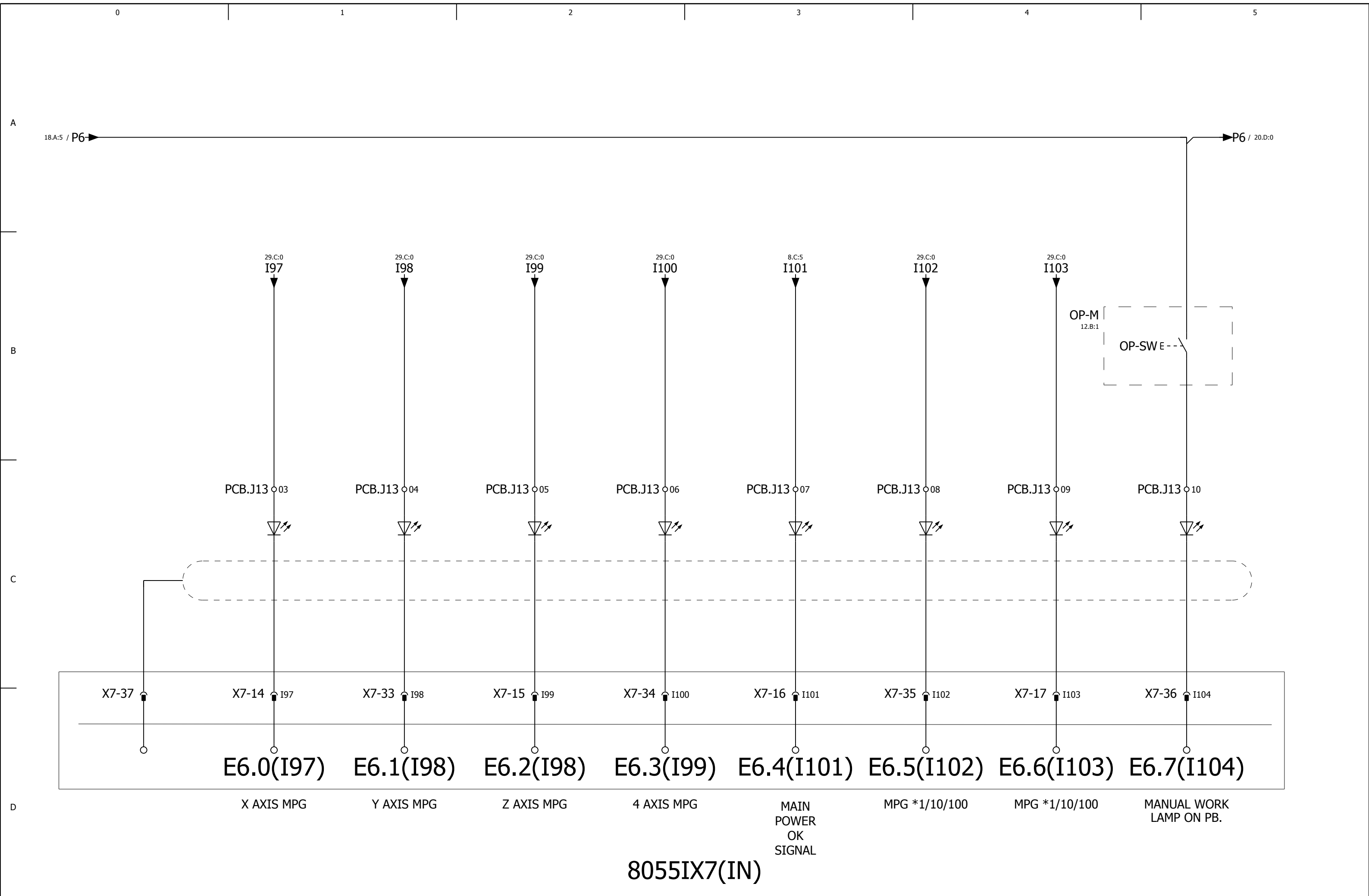

Machine Model	Designaion Standard	Title Paeg	ACER	
FAGOR 8055I CNC	CNC COMTROL UNIT IN-5		Date: 2012/8/28	Ref:
				Page 19
				Page 31

8055IX7(OUT)

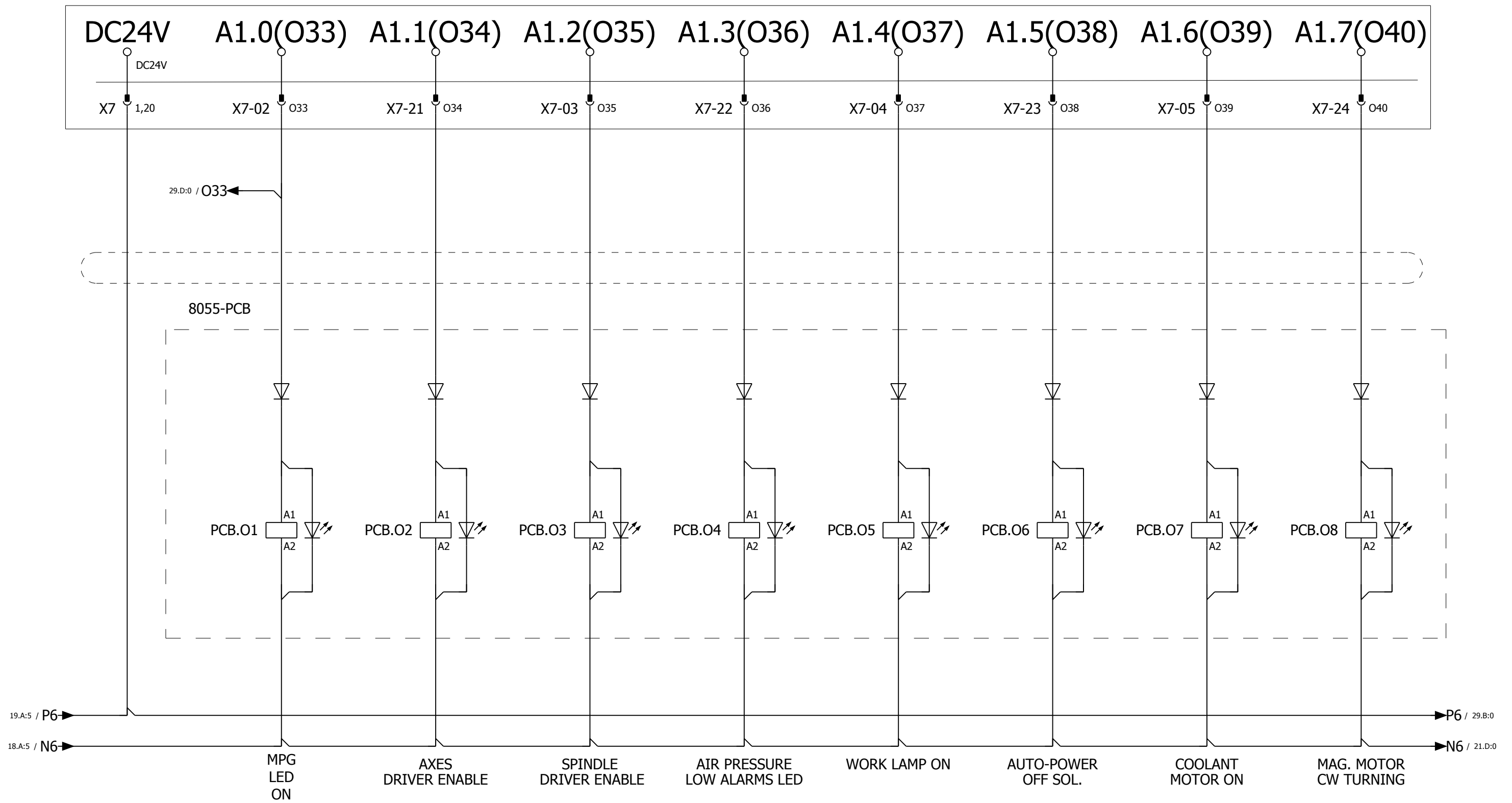

Machine Model	Designaion Standard	Title Paeg	ACER	=
FAGOR 8055I CNC	CNC CONTROL UNIT OUT-1	Date: 2012/8/28	Ref:	+
				Page 20
				Page 31

8055IX10(OUT)

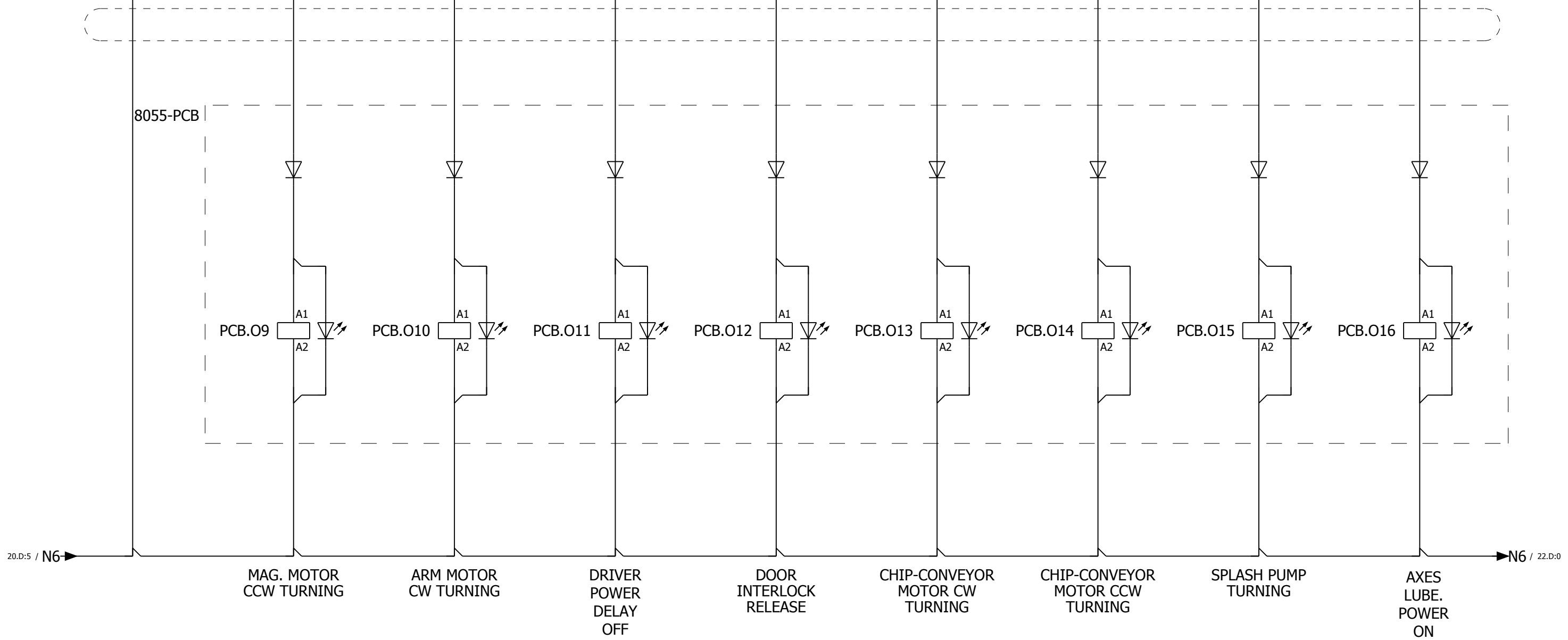
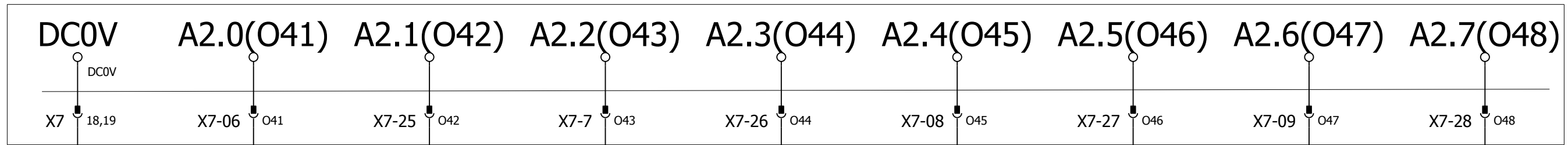

MAG. MOTOR CCW TURNING ARM MOTOR CW TURNING DRIVER POWER DELAY OFF DOOR INTERLOCK RELEASE CHIP-CONVEYOR MOTOR CW TURNING CHIP-CONVEYOR MOTOR CCW TURNING SPLASH PUMP TURNING AXES LUBE. POWER ON

Machine Model	Designaion Standard	Title Paeg	ACER	=
FAGOR 8055I CNC	CNC CONTROL UNIT OUT-2		Date: 2012/8/28	+
			Ref:	Page 21
				Page 31

8055IX10(OUT)

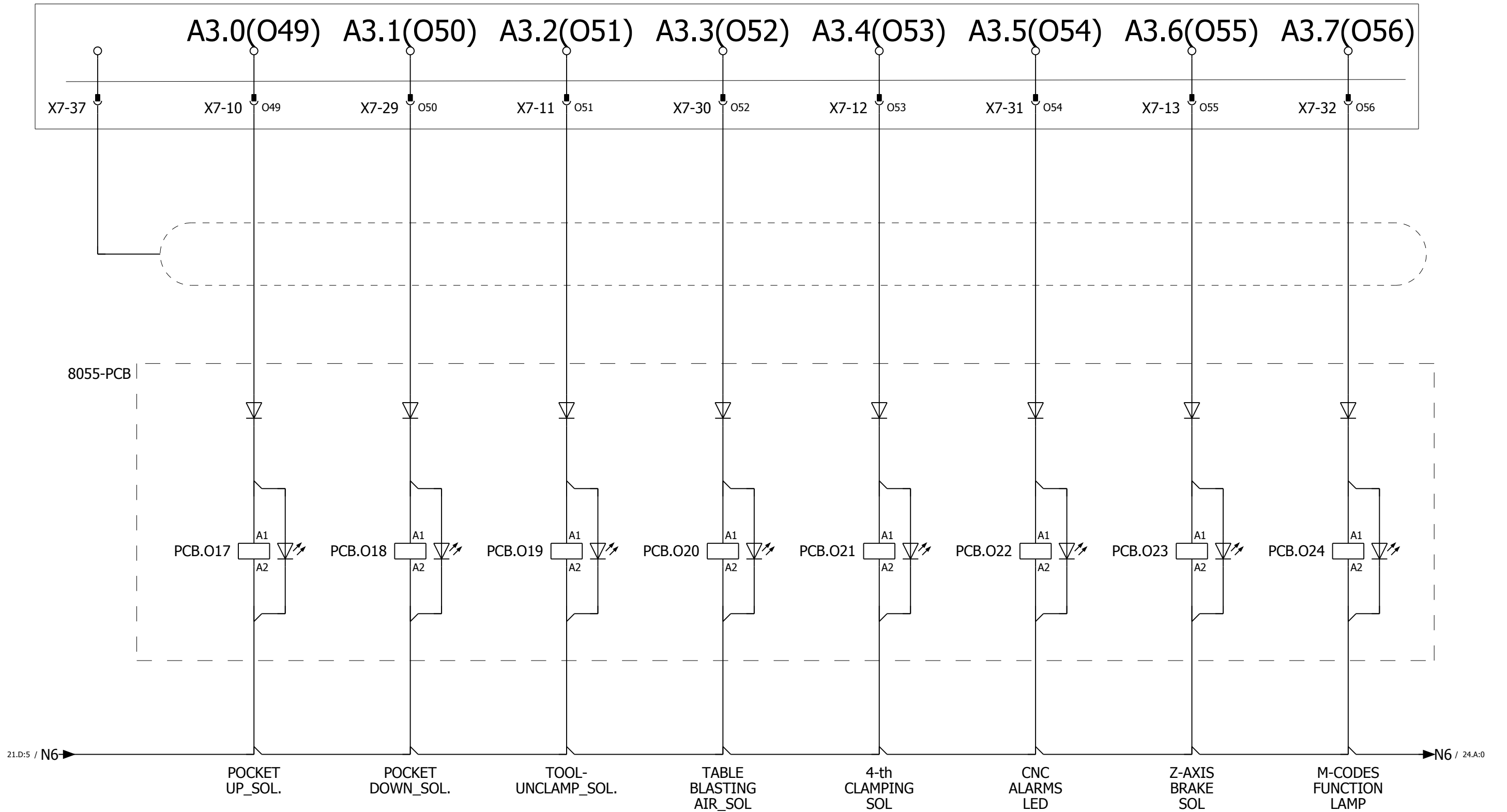

Machine Model	Designaion Standard	Title Paeg	ACER	=
	FAGOR 8055I CNC	CNC CONTROL UNIT OUT-3	Date: 2012/8/28	+
			Ref:	Page 22
				Page 31

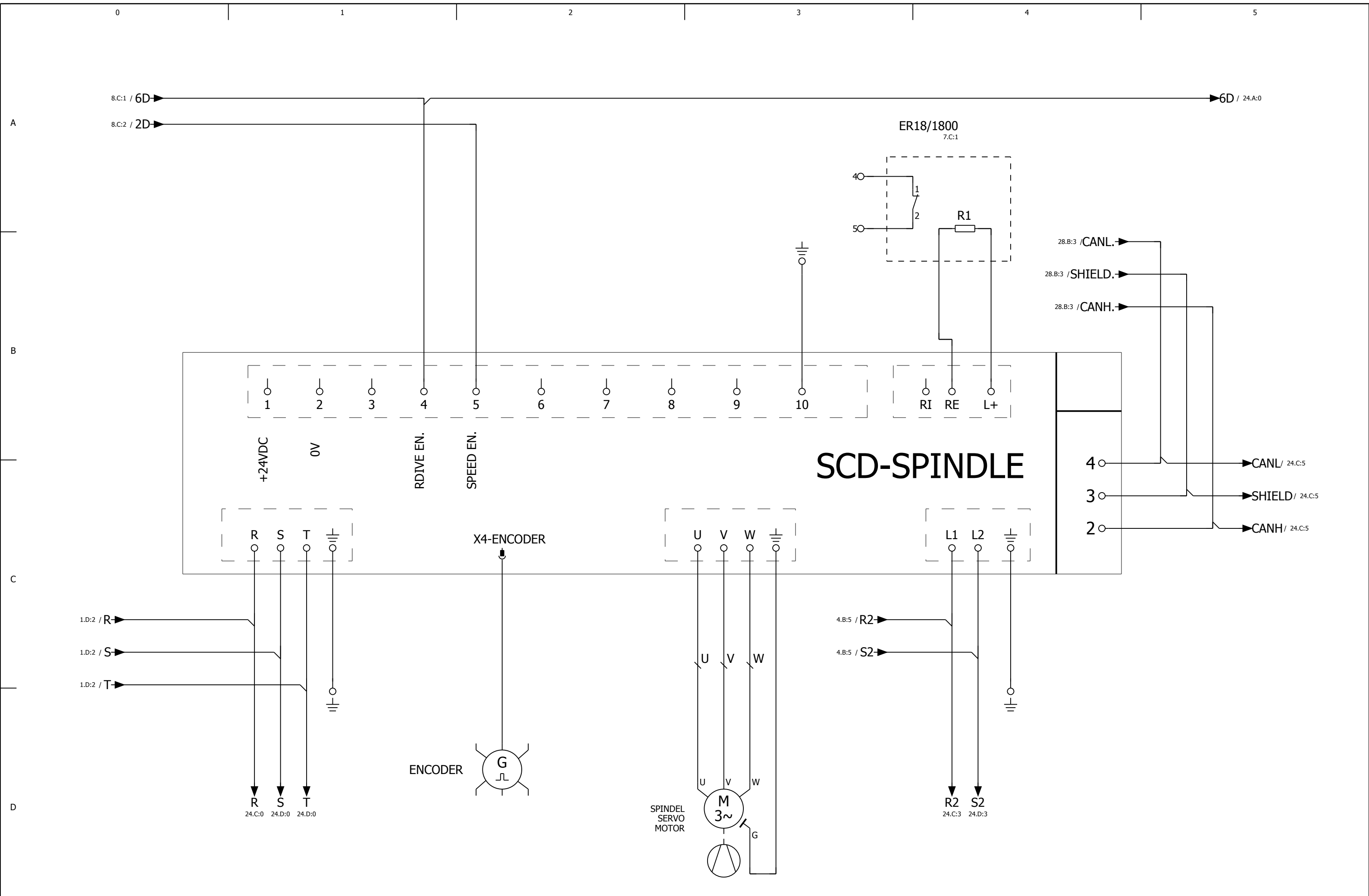

Machine Model	Designaion Standard	Title Paeg	ACER		=
FAGOR 8055I CNC	DRRIVE-SCD-S	Date: 2012/7/27	Ref:		+
				Page 23	
				Page 31	

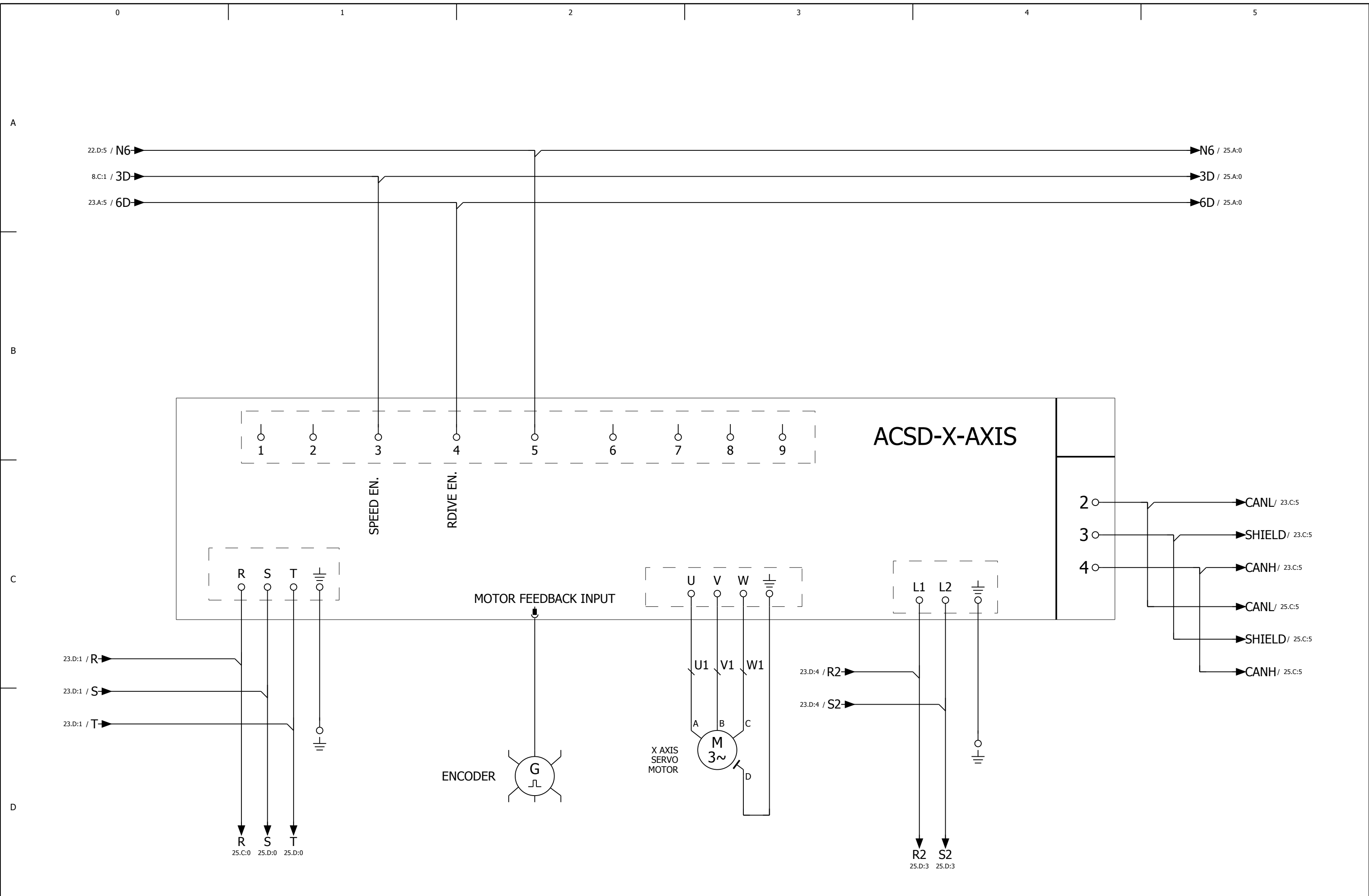

Machine Model	Designaion Standard	Title Paeg	ACER		=
FAGOR 8055I CNC	DRIVE-ACSD-X	Date: 2012/8/28	Ref:		+
				Page 24	
				Page 31	

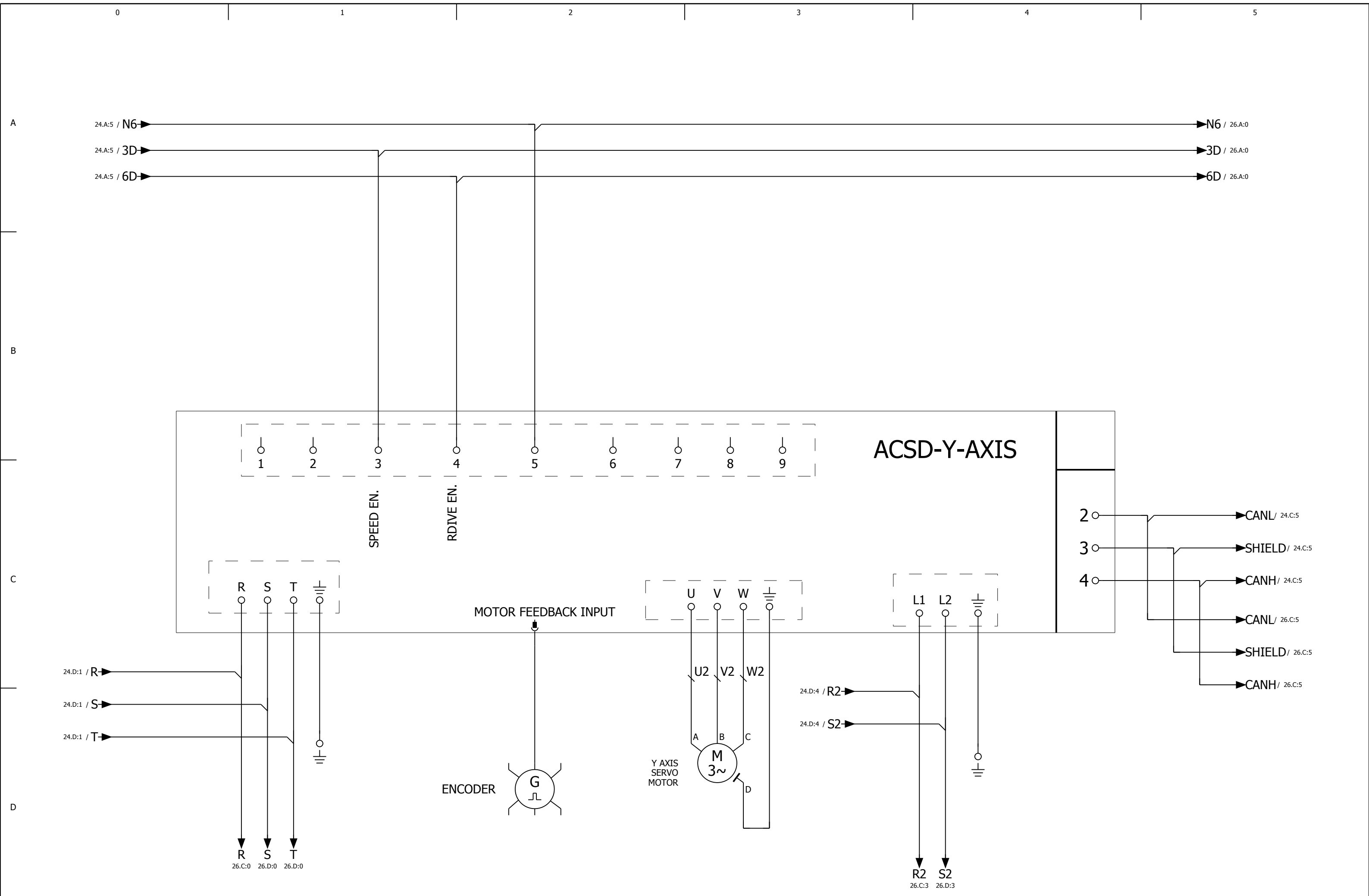

Machine Model	Designaion Standard	Title Paeg	ACER		=
	FAGOR 8055I CNC	DRIVE-ACSD-Y	Date: 2012/8/28	Ref:	+
					Page 25
					Page 31

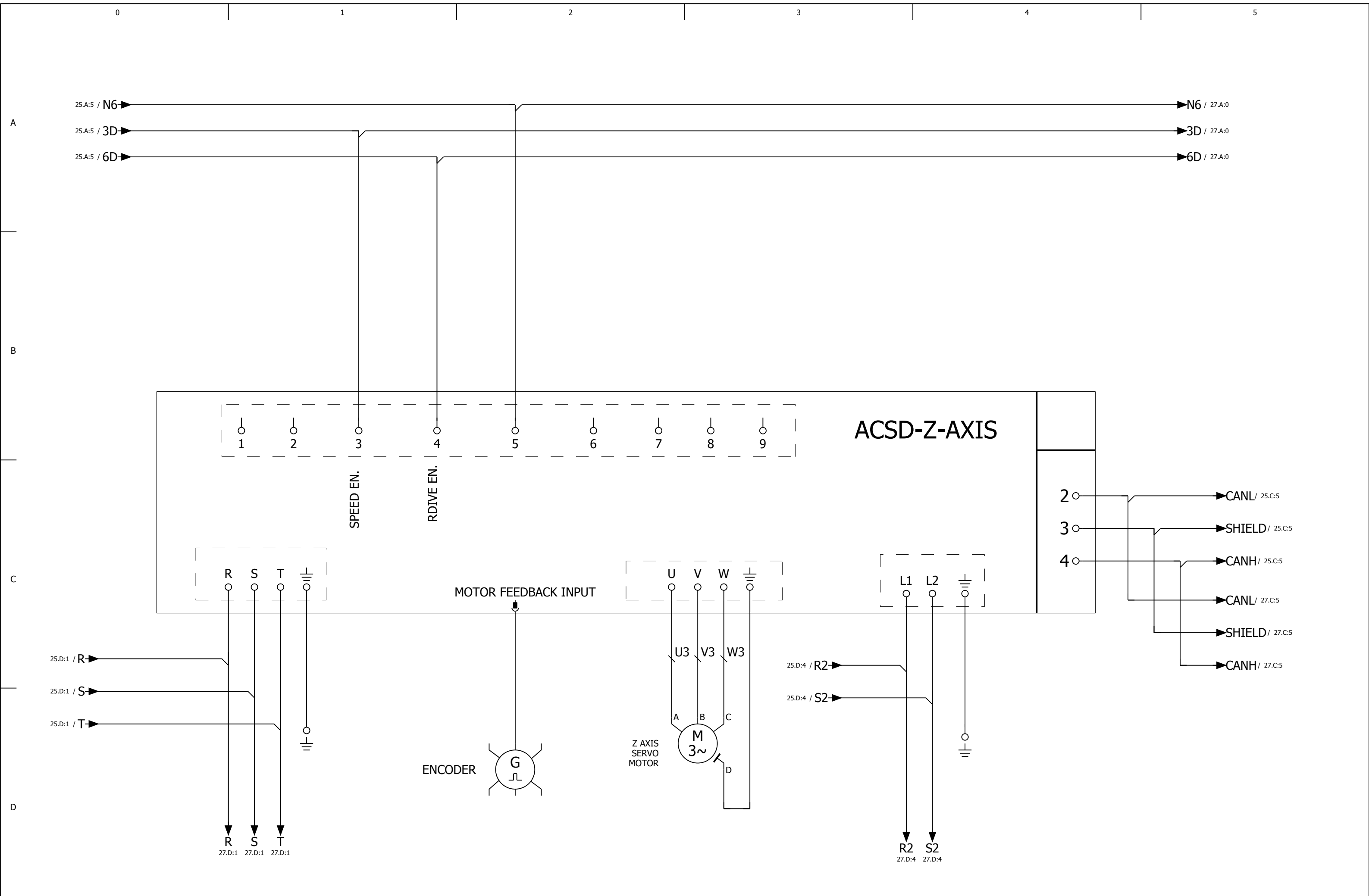

Machine Model	Designaion Standard	Title Paeg	ACER		=
	FAGOR 8055I CNC	DRIVE-ACSD-Z	Date: 2012/8/28	Ref:	+
					Page 26
					Page 31

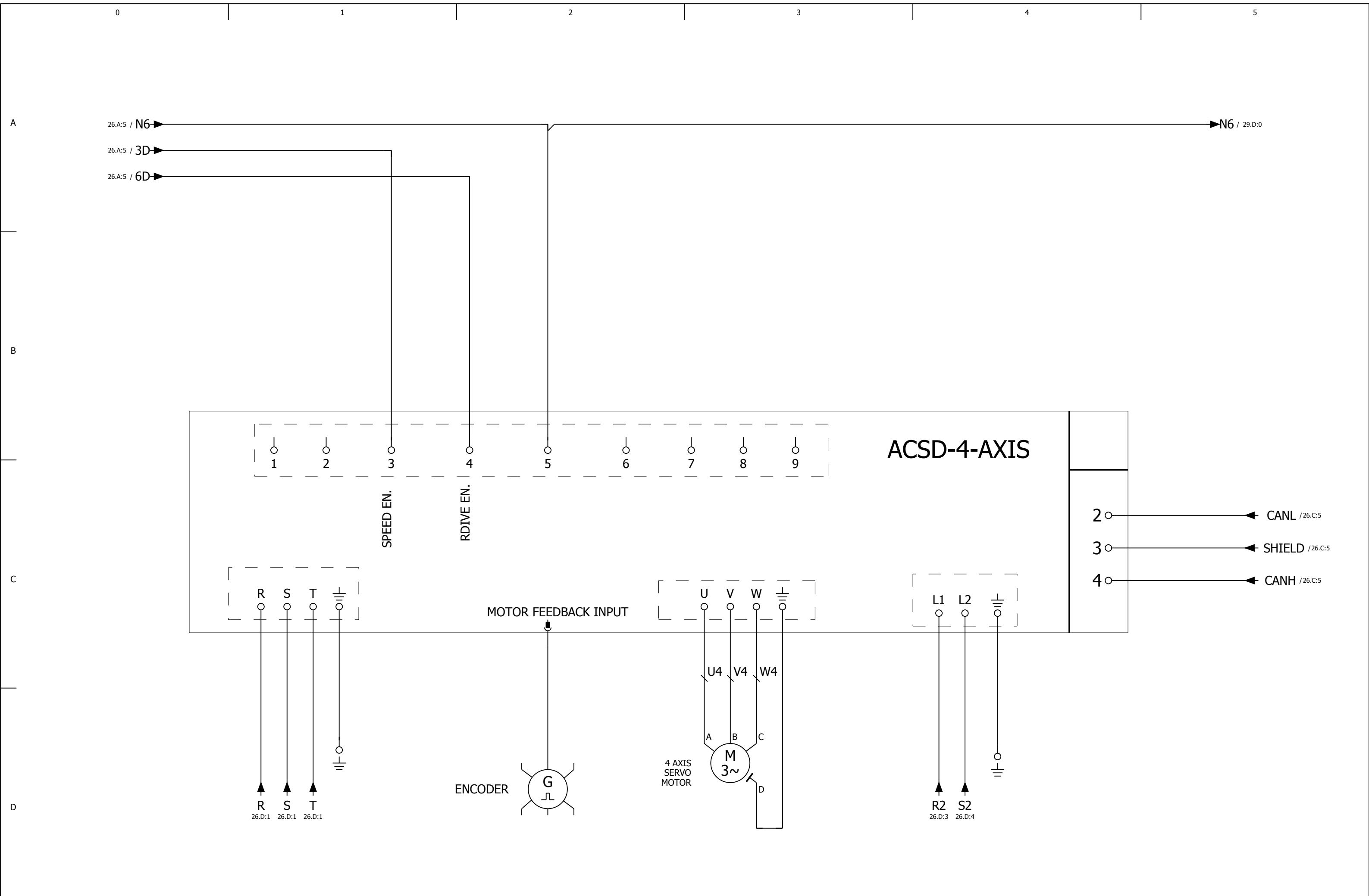

Machine Model	Designaion Standard	Title Paeg	ACER		=
	FAGOR 8055I CNC	DRIVE-ACSD-4TH	Date: 2012/8/28	Ref:	+
					Page 27
					Page 31

8055i-CNC

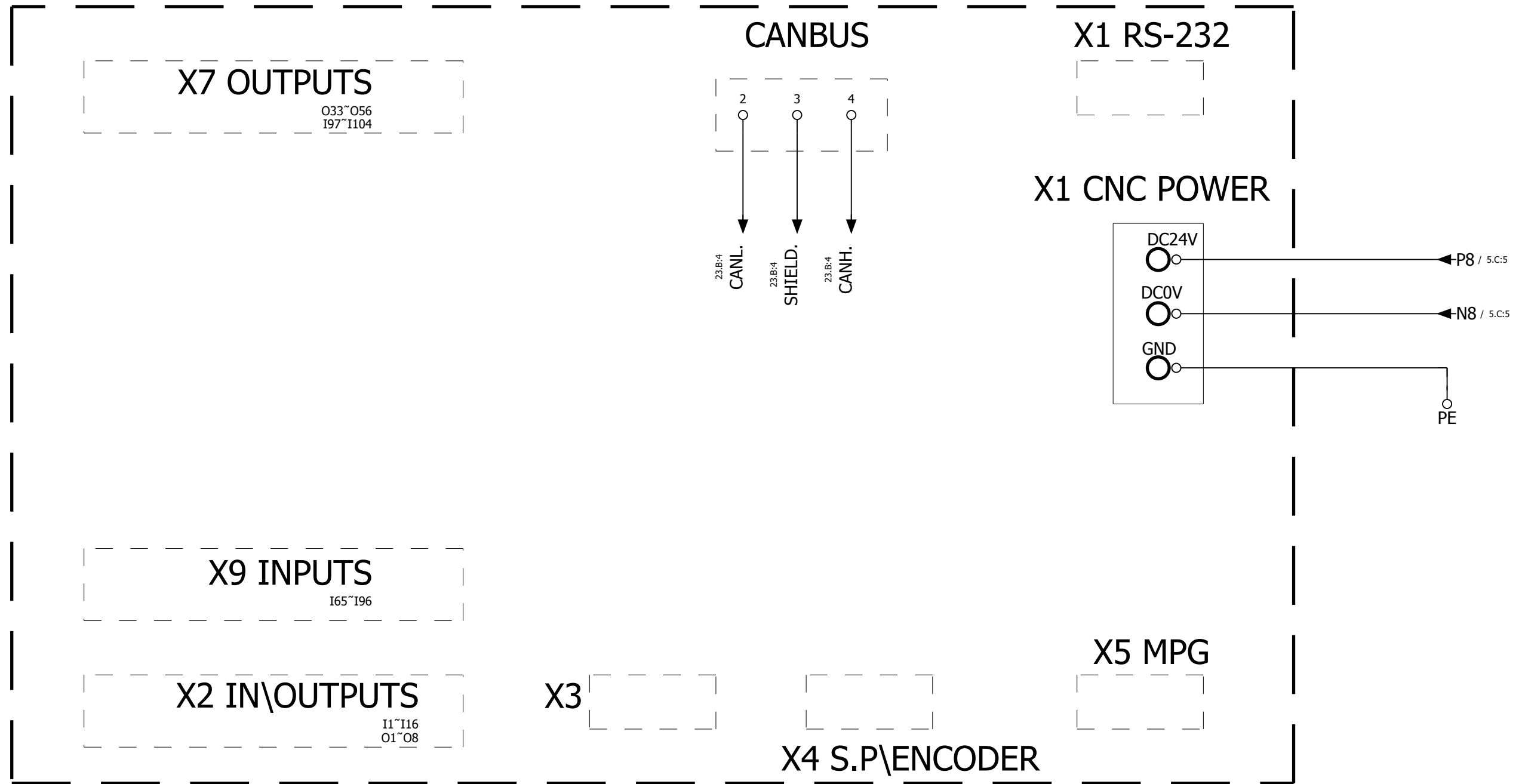

Machine Model	Designaion Standard	Title Paeg	ACER		=
	FAGOR 8055I CNC	CNC	Date: 2012/8/28	Ref:	+
					Page 28
					Page 31

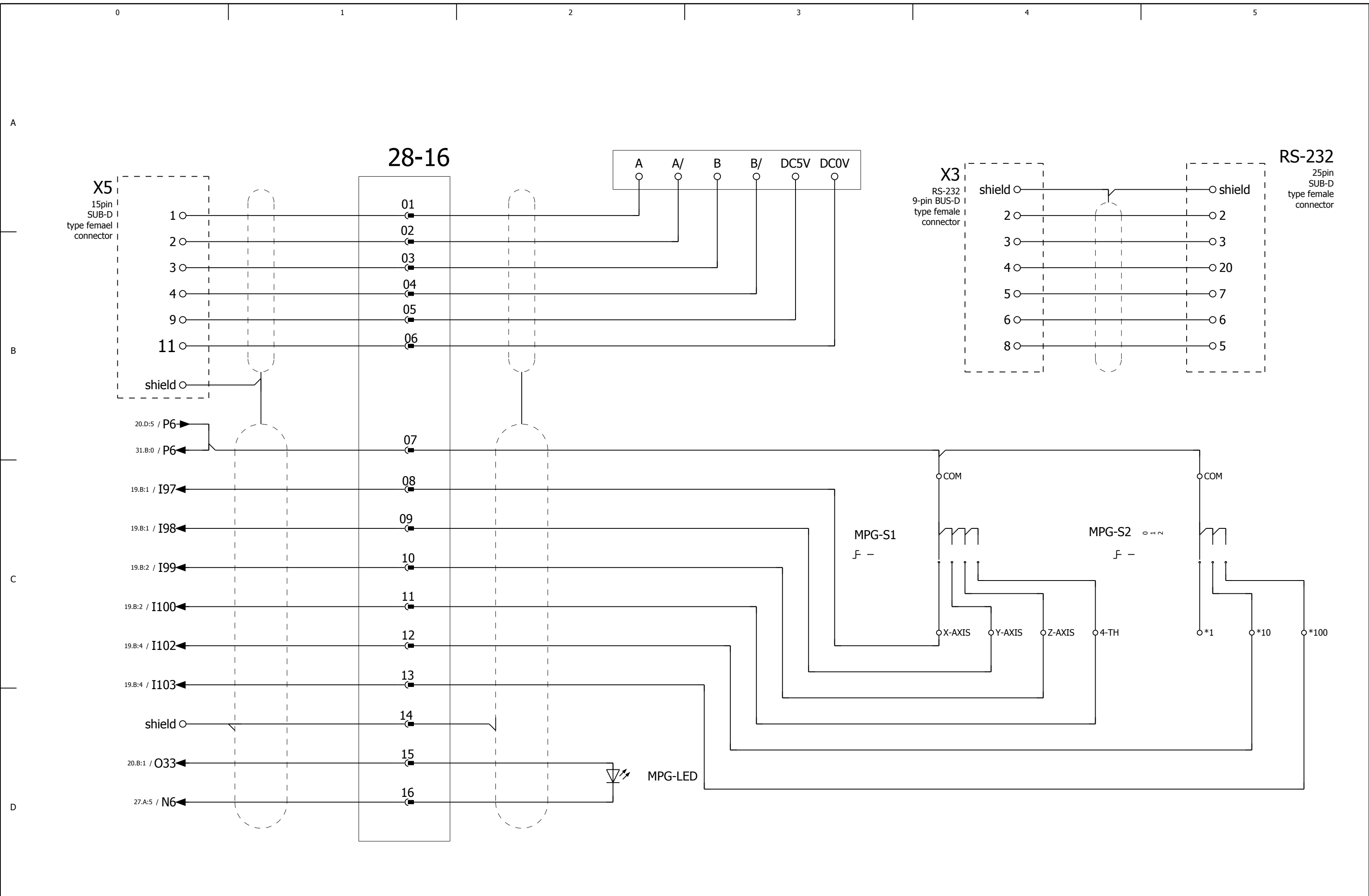

Machine Model	Designaion Standard	Title Paeg	ACER		=
FAGOR 8055I CNC		MPG	Date: 2012/8/28	Ref:	+
					Page 29
					Page 31

AXD-4TH X4

20-29P+S

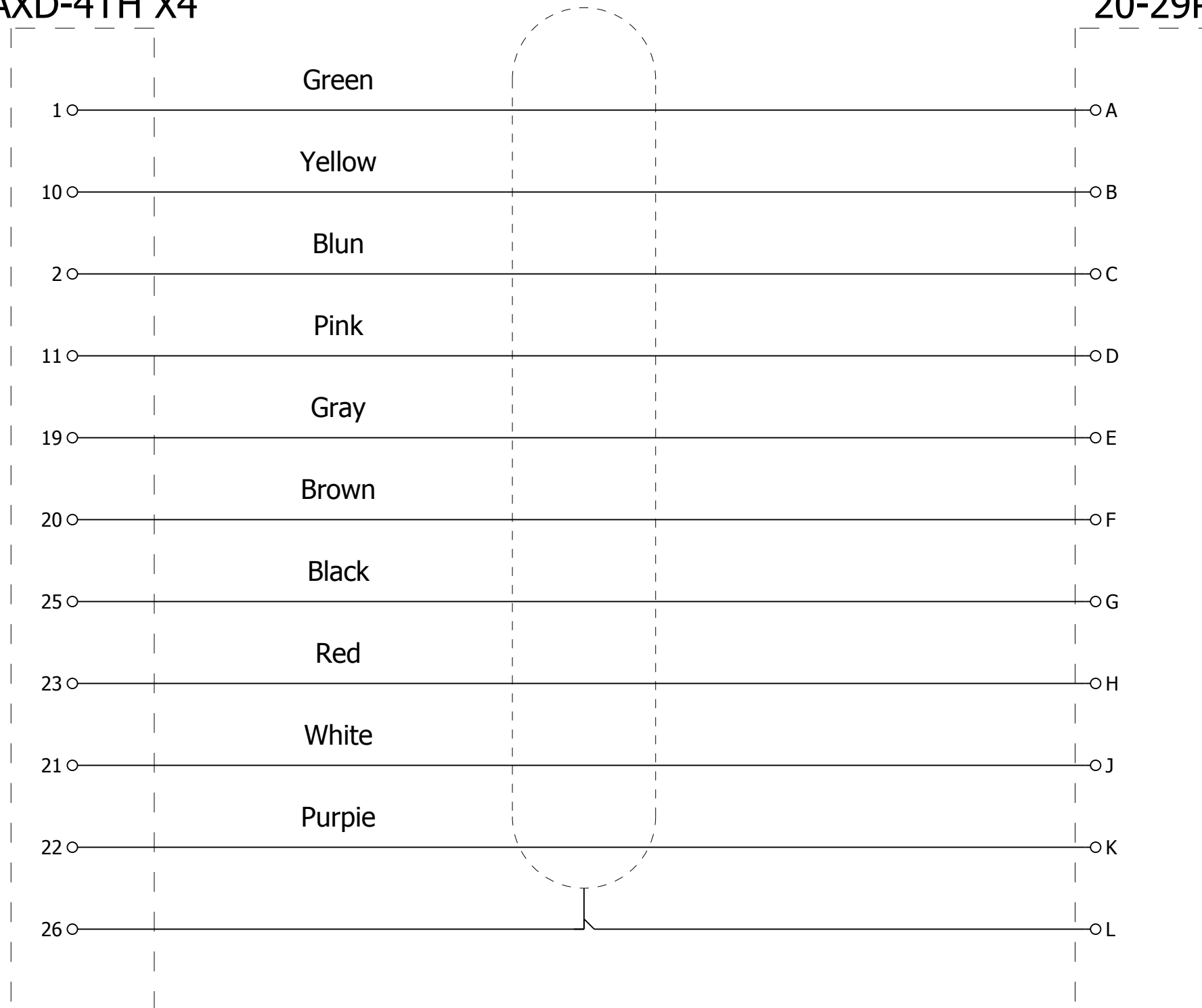

A

B

C

D

29

31

Machine Model	Designaion Standard	Title Paeg	ACER		=
	FAGOR 8055I CNC	4TH	Date: 2011/3/18	Ref:	+
					Page 30
					Page 31

A

28-11 P+S

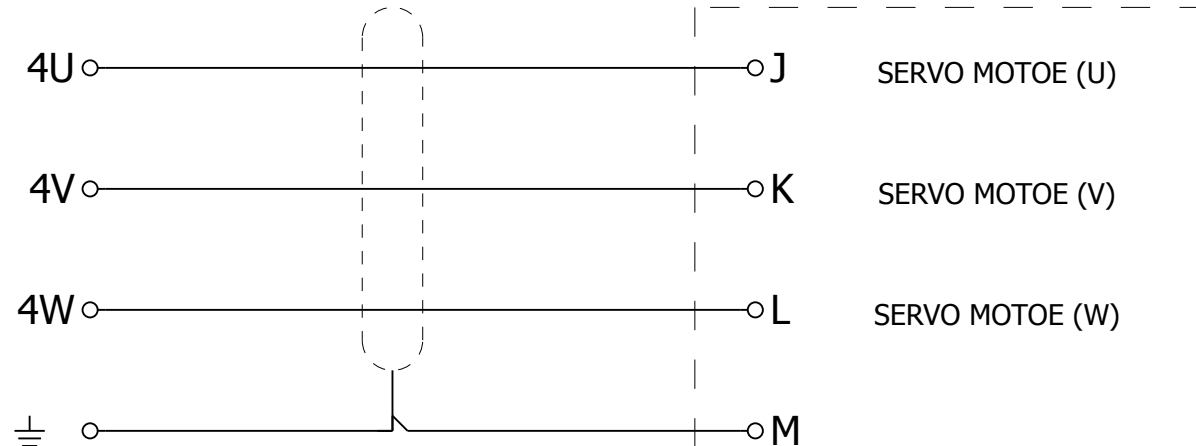

SERVO MOTOE (U)

SERVO MOTOE (V)

SERVO MOTOE (W)

B

29.B:0 / P6

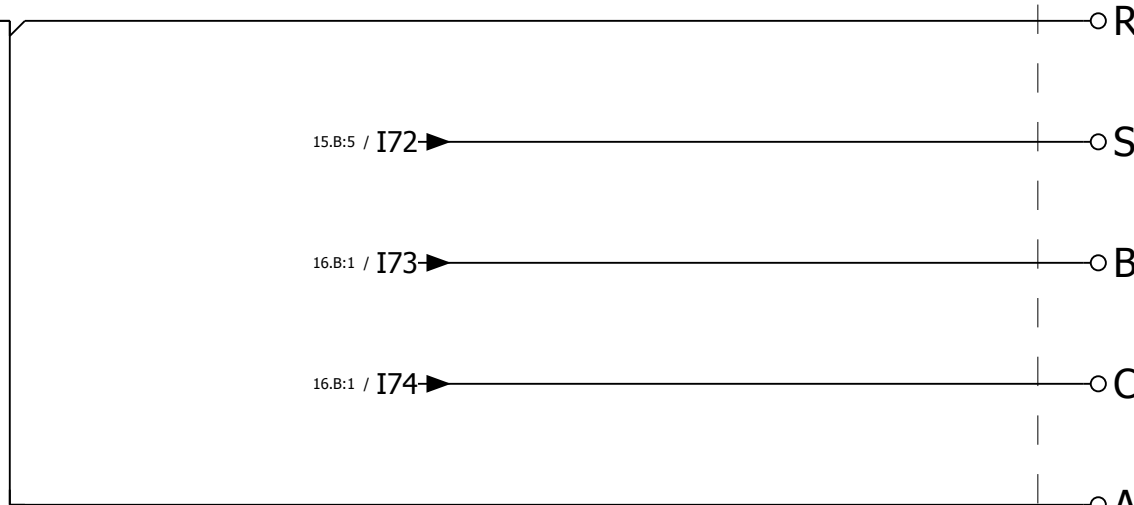

DC24V

4-REFERENCE LS

4-AXIS CLAMP LS

4-AXIS UNCLAMP LS

DC24V

C

11.C:3 / 55

P

DC0V

11.D:5 / N7

N

OUT SOL

D

Machine Model	Designaion Standard	Title Paeg	ACER		=
	FAGOR 8055I CNC	4TH-POWER	Date: 2012/8/28	Ref:	+
					Page 31
					Page 31