

# ANILAM



## 6000M CNC Control TRAINING GUIDE

# Navigation Instructions

## Bookmarks

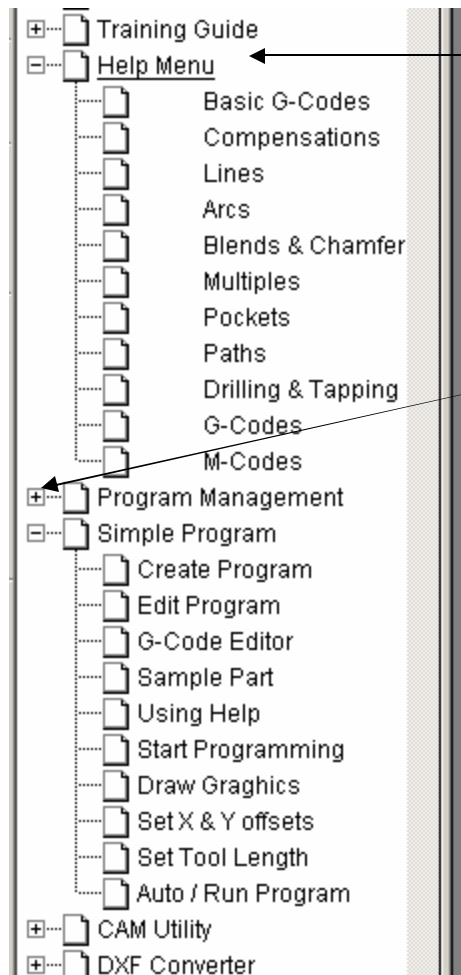

Follow the bookmarks at the left side of the page to navigate to desired topic.

Click plus and minus symbols to expand and compress menu display.

## 5000M CNC CONTROL TRAINING GUIDE



## Turning the Control ON

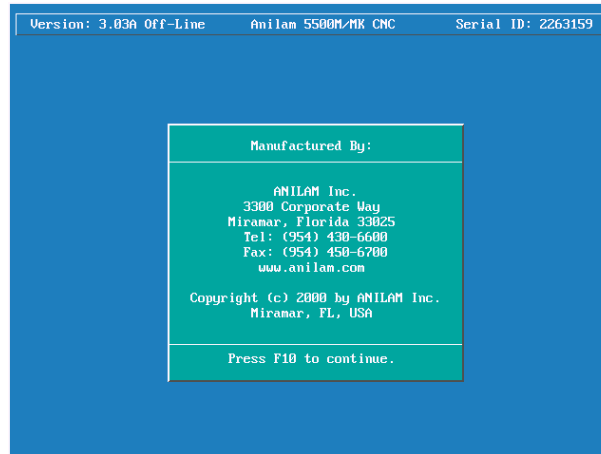

After the control has been turned ON press F10 to continue.

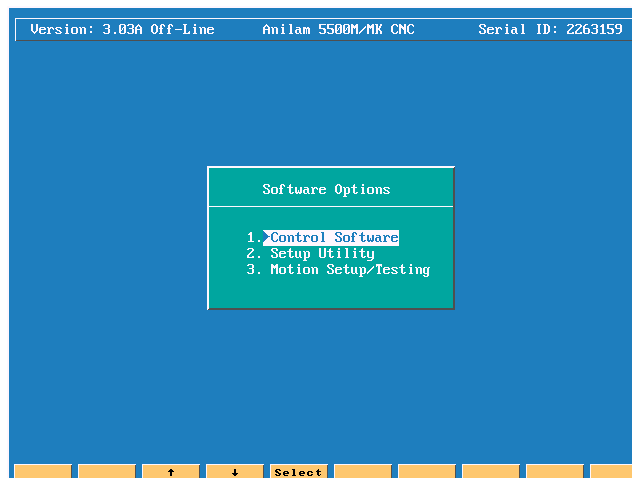
**F10**

- |                                |                                    |
|--------------------------------|------------------------------------|
| <b>1. Control Software</b>     | This allows you enter CNC software |
| <b>2. Setup Utility</b>        | Machine configuration              |
| <b>3. Motion Setup/Testing</b> | Used to setup drive                |

Then press ENTER



to select CNC mode.

**1.**

## First CNC Screen

## Control Manual Screen

PROGRAM: **SAX-SP2.M** HALTED **MANUAL** IN-POSN

COMMAND: \_

MESSAGE:

MACHINE	PROGRAM	TARGET	DIST. TO GO
X + 0.0000	X + 0.0000	X	X + 0.0000
Y + 0.0000	Y + 0.0000	Y	Y + 0.0000
Z + 0.0000	Z + 0.0000	Z	Z + 0.0000
U + 0.000	U + 0.000	U	U + 0.000
W + 0.000	W + 0.000	W	W + 0.000

TOOL: 0	RPM: 0	∅: 100	LOOP: 0	FIXTURE: 0
DIA: 0.0000	FEED: 0.0	∅: 100	DWELL: 0.0	
LENG: 0.0000			OVERRIDE: FEED, RAPID	

G: G01 G17 G40 G70 G90	PARTS: 0
M: M05 M09	TIMER: 00:00:00 (00:00:00)

Help Program Edit **Manual** S.Step Auto Delete Insert Tool HandWI

SECTION #1

SECTION #2

SECTION #3

**Section #1**

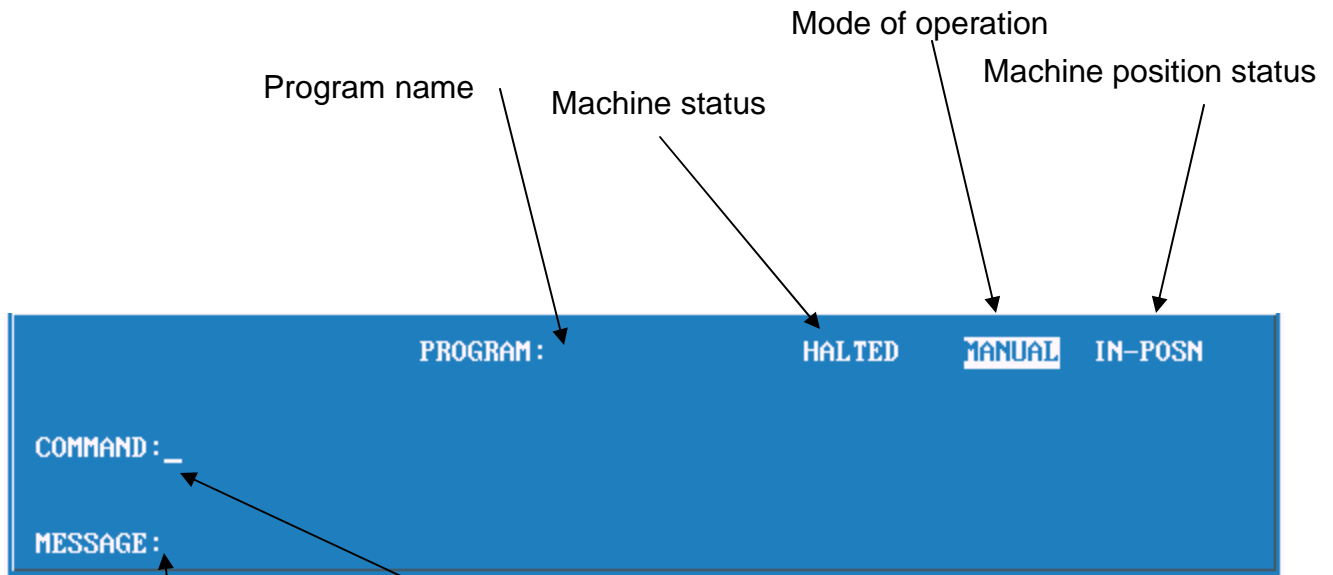

Messages display in this area  
Error and warnings

Command line for **MANUAL**(MDI) instructions

**Section #2**

MACHINE	PROGRAM	TARGET	DIST. TO GO
X + 0.0000	X + 0.0000	X	X + 0.0000
Y + 0.0000	Y + 0.0000	Y	Y + 0.0000
Z + 0.0000	Z + 0.0000	Z	Z + 0.0000
U + 0.000	U + 0.000	U	U + 0.000
W + 0.000	W + 0.000	W	W + 0.000

Position relative to machine HOME

Position relative to part ZERO

Target or position to reach

Distance to go to reach target

**Section #3**

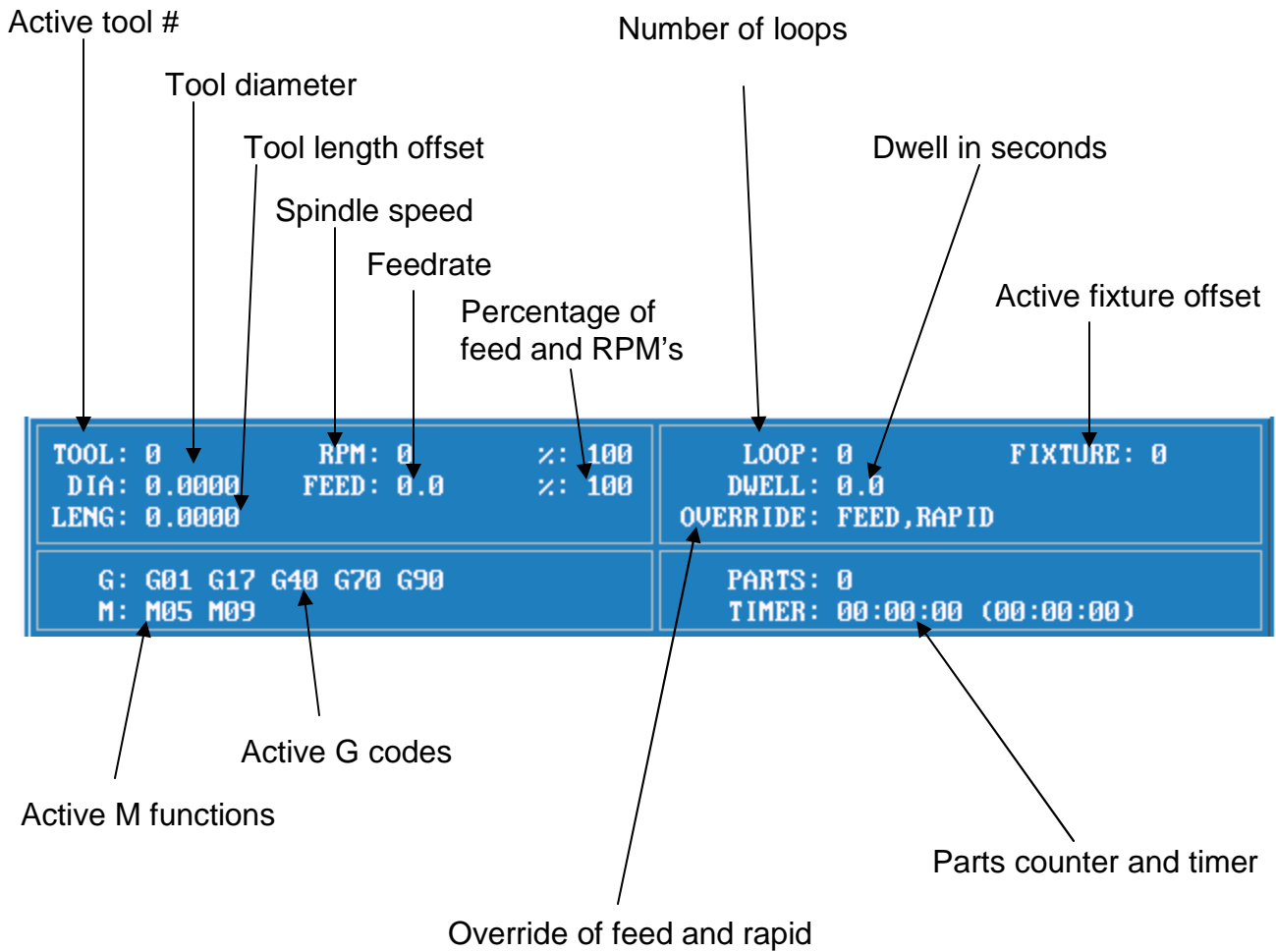

### Softkey in Manual Mode

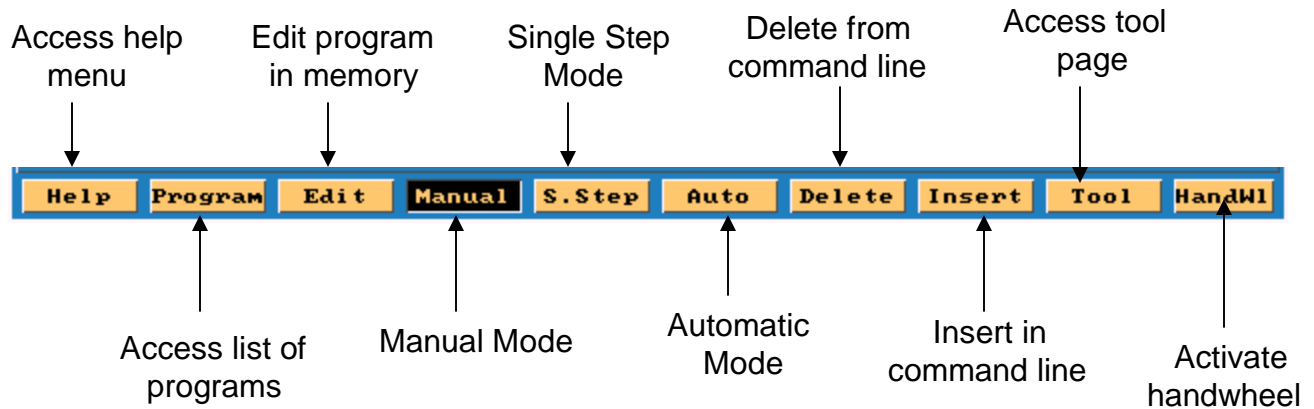

**Note:**When handwheel is active colors will be reversed in box as shown below.

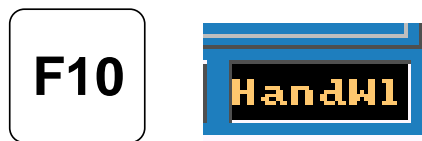

### Softkey in Manual mode when shift key is pressed

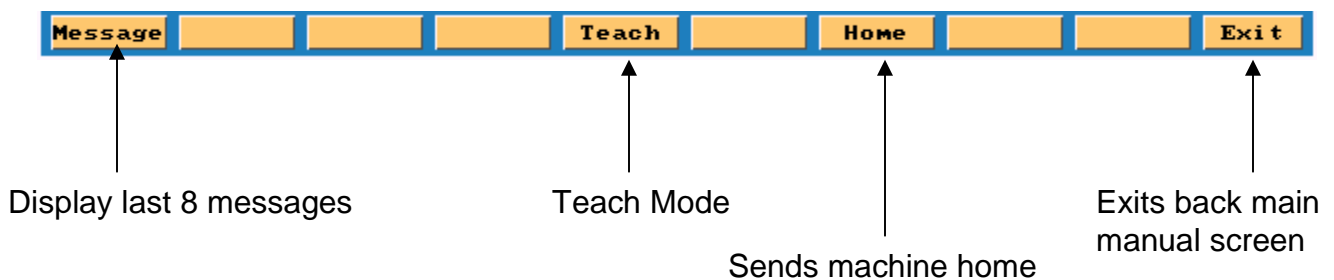



**Alfa - Numeric key board**

**Note :- Most used key are yellow . Most key also double functions , the shift key is use to use secondary functions.**

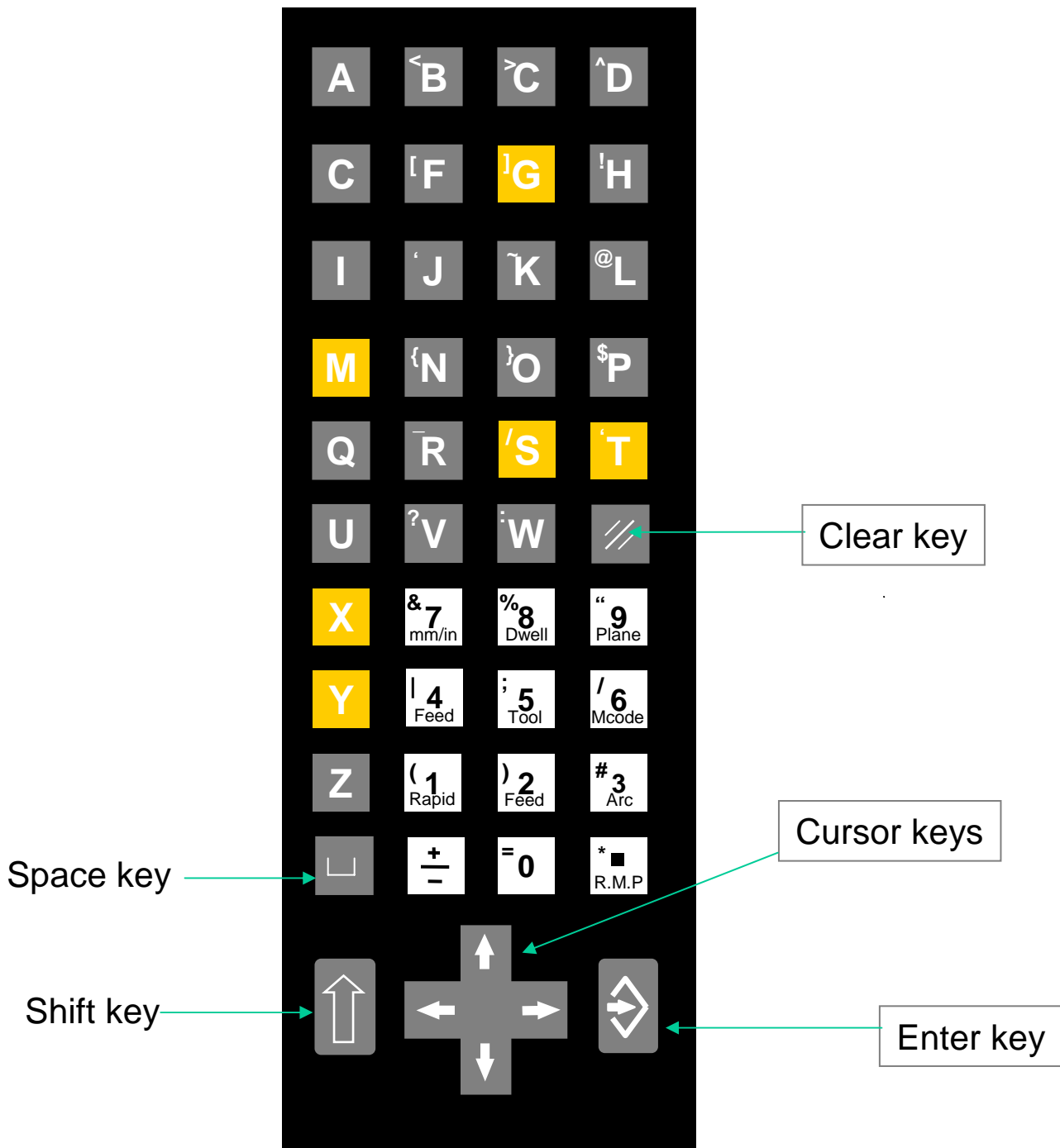



# Manual panel

There are two type of Manual panels.

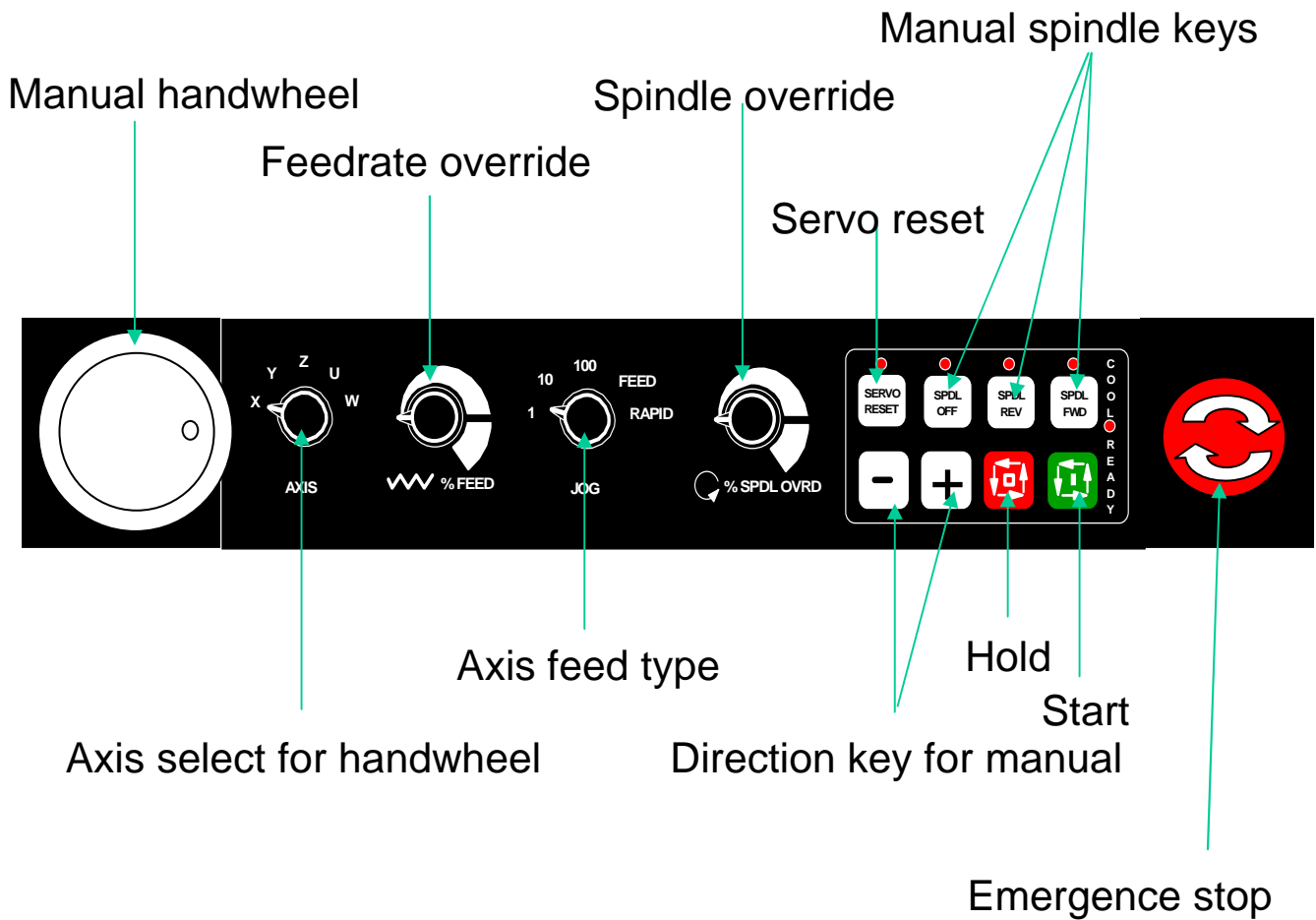
- 1.As shown below.
- 2.The other without Handwheel on left side



## MOVING WITH JOG MOVEMENTS

- 1) Turn the jog mode selector switch on the **MANUAL PANEL** to **100, 10, 1, FEED** or **RAPID**
- 2) Select the axis to move with the **AXIS SELECTOR** switch at the **MANUAL PANEL**
- 3) Press the  or the  key to move in the desired direction.

## MOVING WITH COMMANDS

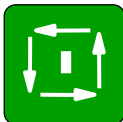
Type commands as needed and press the START button  located on the MANUAL PANEL

EXAMPLE:

Type: **G0 G90 Z-5.** and press Start  Z axis goes to Z-5. in ABS and RAPID

EXAMPLE:

Type **G97 S1000 M3** and press START  to start the spindle at a fixed 1000 rpm.

**MOST COMMON G-CODE COMMANDS TO REMEMBER:**

<b>G00:</b>	Rapid move.
<b>G01:</b>	Feed move.
<b>G02:</b>	Arc clockwise
<b>G03:</b>	Arc counter clockwise
<b>G17:</b>	XY plane
<b>G18:</b>	XZ plane
<b>G19:</b>	Yz plane
<b>G40:</b>	Cutter comp off
<b>G41:</b>	Cutter comp left
<b>G42:</b>	Cutter comp right
<b>G53 Ox:</b>	Fixture offsets ( absolute shift from Machine Home).
<b>G70:</b>	Inch programming
<b>G71:</b>	MM programming
<b>G80:</b>	Used for <b>Drilling</b> Cycles.
<b>G90:</b>	Absolute co-ordinate system
<b>G91:</b>	Incremental co-ordinate system
<b>G92:</b>	Incremental shift
<b>G94:</b>	Feed Rate in Inch per minute (mm per minute).
<b>G95:</b>	Feed Rate in Inch per revolution (mm per revolution)
<b>M0:</b>	Stop program .
<b>M2:</b>	End of program
<b>M3:</b>	Spindle forward
<b>M4:</b>	Spindle reverse
<b>M5:</b>	Spindle OFF
<b>M8:</b>	Coolant ON
<b>M9:</b>	Coolant OFF

**ADDRESS LETTERS USED IN PROGRAMMING**

<b>A:</b>	Used for angles around X axis.
<b>B:</b>	Used for angles around Y axis.
<b>C:</b>	Used for angles around Z axis.
<b>D:</b>	Designates tool diameter in a program.
<b>F:</b>	Feedrate.
<b>I:</b>	Circle center X axis.
<b>J:</b>	Circle center Y axis.
<b>K:</b>	Circle center Z axis.
<b>L:</b>	Designates tool length in a program.
<b>M:</b>	Miscellaneous functions.
<b>N:</b>	Line number prefix.
<b>O:</b>	Program or subroutine number prefix.
<b>P:</b>	Subroutine number call prefix.
<b>S:</b>	R.P.M. prefix.
<b>T:</b>	Tool call.
<b>U:</b>	Rotary axis or spindle.
<b>V:</b>	Rotary axis or spindle.
<b>W:</b>	Rotary axis or spindle.
<b>LOOP:</b>	Repeat operation.
<b>END:</b>	End of loop.

Note: Some of these letters are used inside canned cycles also some that are not listed above.

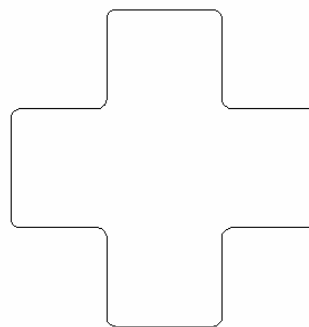

## RETRIEVING PROGRAMS FROM DISK

### Transferring a program from a disk into the control

Programs can be restored into the control if they have been previously saved on a disk.

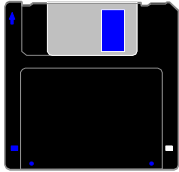

Insert the disk into the floppy disk drive (**A:**) on the machine.

From the MANUAL mode press **Program** then press **SHIFT**



Next, press **Log** select "**A:**" and press **ENTER**



Using the arrow keys hi-lite the program to be restored and press

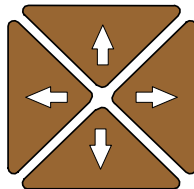

**Utility**

then press















twice to select **COPY** and then **C:**

### **WARNING**

**Remove the diskette when complete and save in a safe place. Do not leave the diskette in the machine, the will not start correctly with disk in the drive.**

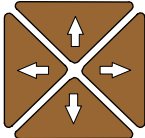
Keys to use when using Computer key board

FUNCTION	CNC KEYBOARD	COMPUTER KEYBOARD
X Axis Command		X Key
Y Axis Command		Y Key
Z Axis Command		Z Key
Preparity G Code		G Key
Machine Function Code		M Key
Spindle Function Code		S Key
Tool Command		T Key
ENTER		ENTER Key
SHIFT		SHIFT Key
Cycle HOLD Key		Alt + H Key
Cycle START Key		Alt + S Key
Cursor UP, DOWN, LEFT and RIGHT		ARROW Keys
CLEAR Key		Alt + C Key
FUNCTION Keys F1 - F10		F1 - F10 Keys

Definitions of Function keys are given on screen

## 5000M CNC CONTROL HELP MENU'S





The **HELP MENU'S** are access by pressing.



This can be done from either Manual or Edit.

Manual mode soft keys



Edit mode soft keys



First **Help** screen

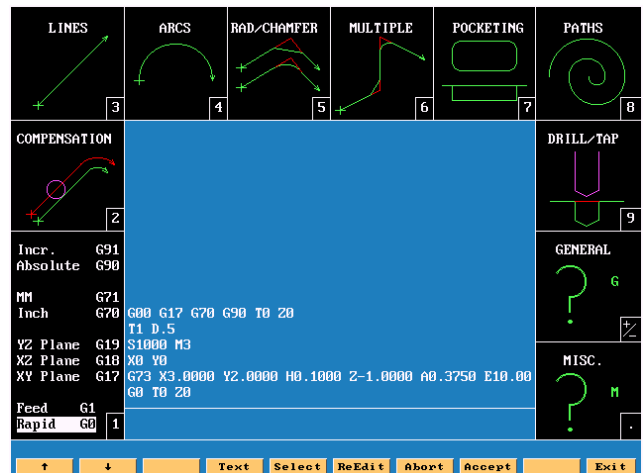
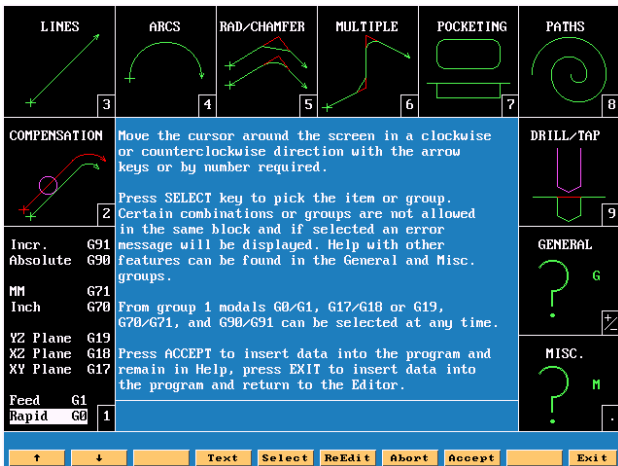

**Note:** The center of the screen. There are two different displays, one has text about **Help** the other shows the program as it is being entered.



will toggle these screens.

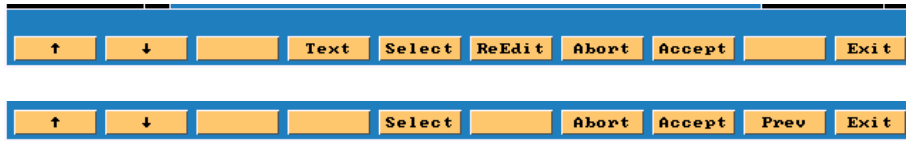

There are two different set of soft keys , as shown above.

<b>F1</b>		Arrow up and around to desired selection.
<b>F2</b>		Arrow down and around to desired selection.
<b>F3</b>		Not used.
<b>F4</b>		Text changes center of screen to display program.
<b>F5</b>		Selects required cycle. Enter will as do this.
<b>F6</b>		ReEdits a cycle after it is already in a program.
<b>F7</b>		Goes back to edit without saving last set of inputs.
<b>F8</b>		Accepts inputs and stays in HELP.
<b>F9</b>		Goes back to previous page in HELP menu.
<b>F10</b>		Exits to EDIT page and saves inputs.

Section as shown below these are the major defaults. Highlight the required in put and

press either **Select** or  enter.

Incr.	G91	i
Absolute	G90	m
		f
		g
MM	G71	F
Inch	G70	G
		P
YZ Plane	G19	r
XZ Plane	G18	t
XY Plane	G17	
Feed	G1	
Rapid	G0	1

Use up arrow key to move high to next selection.

Press the number 2 key or arrow up to number 2 .

Press either **Select** or  enter

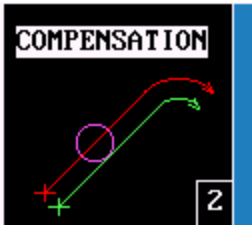

Note:- the reverse color around Compensation.

Press either **Select** or  enter

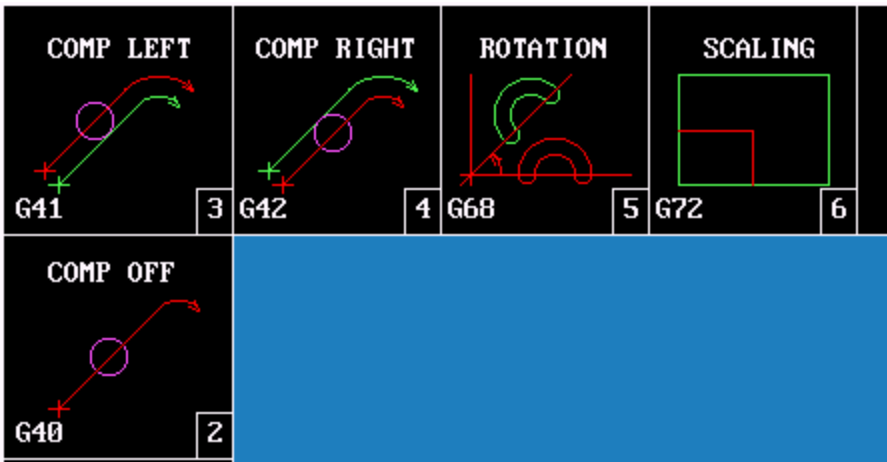

1. Puts a **G40** into program comp off.
2. Enters **G41** into program cutter comp left.
3. Enters **G42** into program cutter comp right.
4. **G68** rotates a shape around a center.
5. **G72** scale program to required size.

## Rotation G68

**G68 - ROTATION**

NOTE: G68 alone, cancels rotation.  
If P and L used, S must be used.



Rotation ctr.I

Rotation ctr.J

First Angle S

Angle C +0.00000

Subprogram # P

Num of Times L

- ← Center of rotation X axis.
- ← Center of rotation Y axis.
- ← Start angle when using loop.
- ← Angle between loops or single shot.
- ← Subroutine #.
- ← Number of repeats.

**Note:**The only entry that has to be program is **C** because it has 0 (Zero's) next to it.

This cycle can be programmed in main program or in a subroutine. If programmed in the main, the cycle is entered and then the dimension of the shape and turned off with a **G68**.

```
G00 G17 G70 G90 T0 Z0
T1
S1000 M3
X5 Y4
G68 I5.0000 J4.0000 C45.00000
G0 X7 Y4 Z.1
G1 Z-.2
X9
Z.1
G68
G0 T0 Z0
X-1 Y-1
M2
```

This example is show rotation just one time not using a subroutine,note the G68 to turn off rotation.

```
G00 G17 G70 G90 T0 Z0
T1
S1000 M3
X5 Y4
G68 I5.0000J4.0000S0.0000C45.0000P1L8
G0 T0 Z0
X-1 Y-1
M2

O1
G0 X7 Y4 Z.1
G1 Z-.2
X9
Z.1
M99
```

Example on left show rotation using subroutine, note there is no **G68** turning off rotation ,it's not required when programming this way.

## Scaling G72

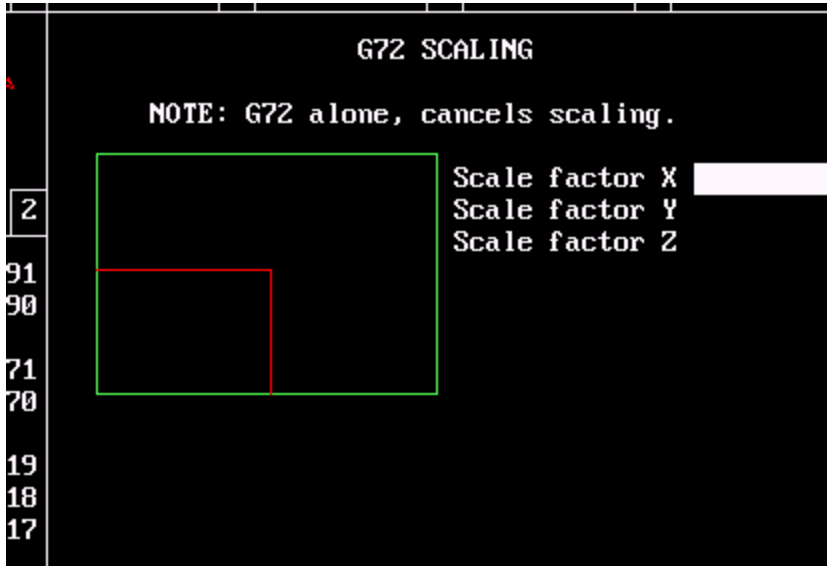

When using scaling if there are any the axis must be scaled the same on both of these axis. If part is required to be half size .5 would be factor. G72 alone will turn off scaling.

Lines

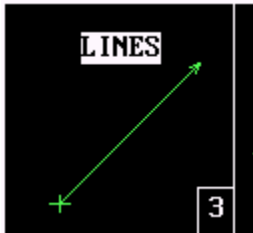

Press # 3 either



or



enter.

Screen will now appear as below.

Inputs will change according to which plane is active.

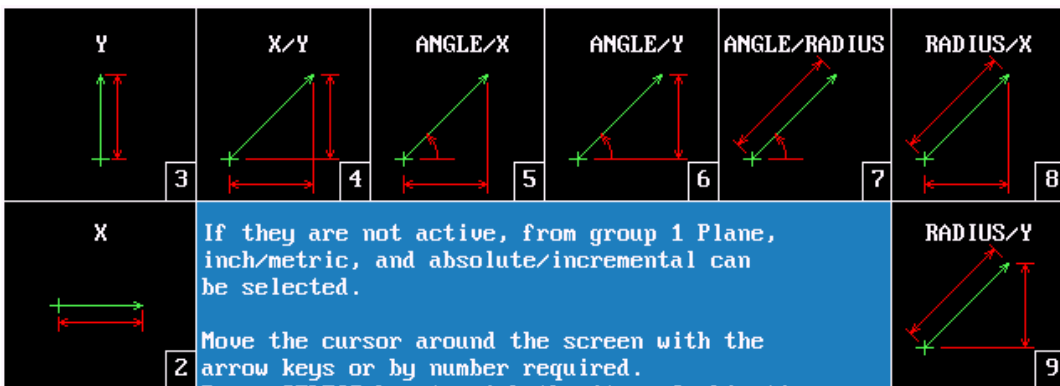

- 2. **X** axis input only.
- 3. **Y** axis input only.
- 4. **X** and **Y** axis.
- 5. **Angle** and **X** axis.
- 6. **Angle** and **Y** axis.
- 7. **Angle** and **Radius**
- 8. **Radius** and **X** axis
- 9. **Radius** and **Y** axis

Arc's

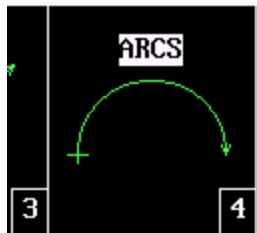

Press # 4 either

**Select**

or



enter.

Screen will now appear as below.

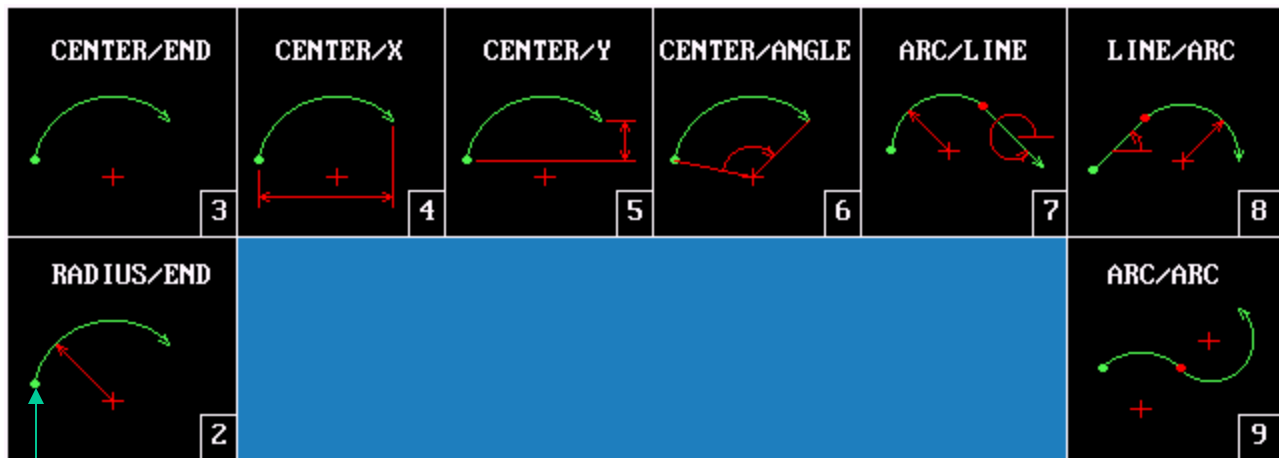

Tool must be at start point before inputting arc's

Centers of arcs X=I , Y=J and Z=K

Inputs will change according active plane.

2. **Radius and End Point.**
3. **Center and End Point.** This can be used for helical interpolation (thead mill.)
4. **Center and X End Point.**
5. **Center and Y End Point.**
6. **Center and Angle.** Angle is dependant Absolute or increamental.
7. **Arc and Line.** Inputs are Radius, Angle and End Point X and Y
8. **Line and Arc.** Inputs are Angle, Radius and End Point X and Y
9. **Arc and Arc.** Inputs Center X and Y first arc, Center X and Y second arc and End Point X /Y



**Corner Rounding And Chamfering**

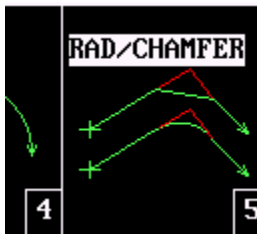

Press # 5 either

**Select**

or



enter.

Screen will now appear as below.

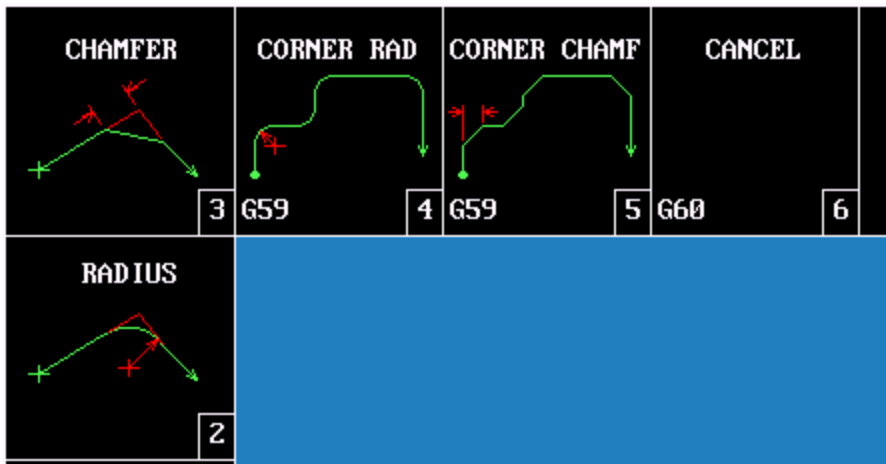

- 2. Radius** One shot corner rounding. Inputs mid point X / Y, radius and end point X/Y.
- 3. Chamfer** One shot chamfer. Inputs mid point X/Y, chamfer and end point X/Y.
- 4. Corner Radius** Modal command puts radius on all intersects.
- 5. Corner Chamfer** Modal command puts chamfer on all intersects.
- 6. Cancel** Cancels #4 and #5

**Multiple line, arc and chamfer moves.**

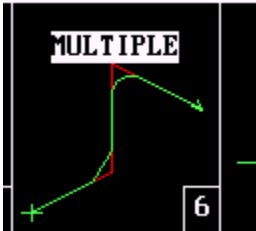

Press # 6 either **Select** or  enter.

Screen will now appear as below.

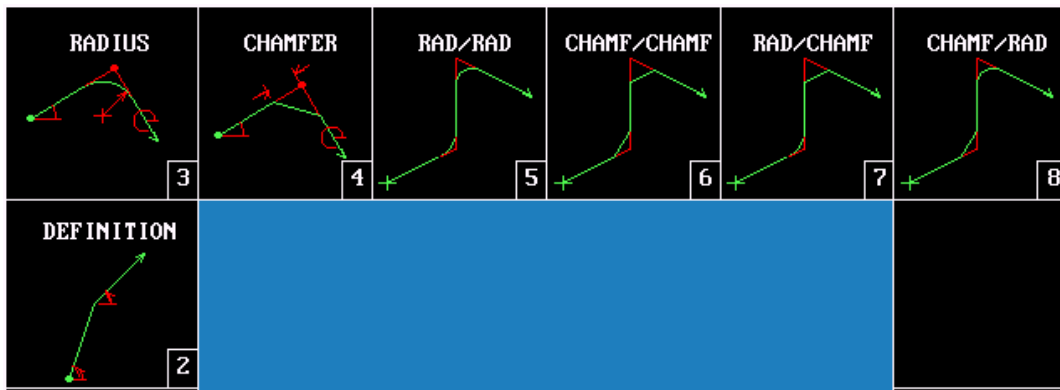

**Tool must be positioned at start point.  
Inputs will change according to active plane.**

- 2. Definition**      Inputs first angle, second angle and end point.
- 3. Radius**            Inputs first angle, radius, second angle and end point.
- 4. Chamfer**            Inputs first angle, radius, second angle and end point.
- 5. Rad/Rad**            Inputs first angle, first radius, second angle, mid point, second radius and end point.
- 6. Chamf/Chamf**      Inputs first angle, first radius, second angle,
- 7. Rad/Chamf**        Inputs first angle, radius, second angle, mid point X/Y chamfer and end point.
- 8. Chamfer/Rad**      Inputs first angle, chamfer, second angle, mid point X/Y, radius and end point.

**Pockets**

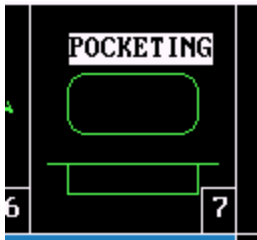

Press # 7 either



or



enter.

Screen will now appear as below.

**Cutter comp is built into all pocket except Mold Rotation.  
X and Y centers are Optional but if not entered will assume it is positioned at center of pocket.**

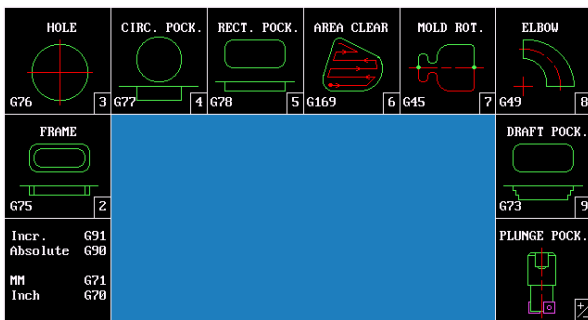

**#2. Frame Milling.**

**#3. Hole Milling.**

**#4. Circular Pocket.**

**#5. Rectangular Pocket.**

**#6. Area Clearance.**

**#7. Mold Rotation.**

**#8. Elbow Milling.**

**#9. Draft Pocket.**

**+/- . Plunge pockets.**

Leave island in middle of pocket.

Enlarges existing hole, used on smaller holes.

Cuts flat bottom circular pocket.

Cuts flat bottom rectangular pocket.

Cuts irregular shape pocket and takes profile cut.

Rotates a profile around an axis.

Produces a radial groove.

Rectangular pocket with angled sides.

Rectangular and circular pocket plunging straight down.

**Plunge Pockets**

**#2. Circular Plunge Pocket**

Plunges straight into material.

**#3. Rectangular Plunge Pocket.**

Plunges straight into material.

## Frame pocket G75

Only the input with in Zeros have to be entered the rest are optional. It will assume being at the center of pocket if no dimension are entered.

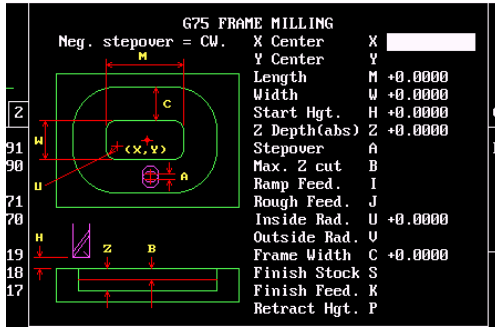

<b>X Center</b>	<b>X</b>	Center of pocket X axis.If not entered will assume tool is at center of pocket.Optional
<b>Y Center</b>	<b>Y</b>	Center of pocket Y axis.If not entered will assume tool is at center of pocket.Optional
<b>Length</b>	<b>M</b>	Length of island (X).
<b>Width</b>	<b>W</b>	Width of island (Y).
<b>Start Hgt.</b>	<b>H</b>	Start height .1inch or 2mm above top surface of pocket.
<b>Z Depth (abs)</b>	<b>Z</b>	Absolute depth to bottom of pocket.
<b>Stepover</b>	<b>A</b>	Cut per pass, not to exceed 70% of cutter dia. Negative value path will climb mill.
<b>Max. Z cut</b>	<b>B</b>	Depth per pass Z axis.Optional
<b>Ramp Feed</b>	<b>I</b>	Feedrate when feeding down into pocket. Optional
<b>Rough Feed</b>	<b>J</b>	Feedrate roughing pocket.Optional
<b>Inside Rad.</b>	<b>U</b>	Radius on corners of island.
<b>Outside Rad.</b>	<b>V</b>	Radius on outside, will assume cutter radius if no entry. Optional
<b>Frame Width</b>	<b>C</b>	Dimension from island to outside.
<b>Finish Stock</b>	<b>S</b>	Amount of material left for finish pass.Optional
<b>Finish Feed</b>	<b>K</b>	Feedrate for finish pass.Optional
<b>Retract Hgt.</b>	<b>P</b>	High retract allows tool to be move above the surface part when finished. Optional

## Hole Milling G76

A good use for this cycle to produce small counterbores.

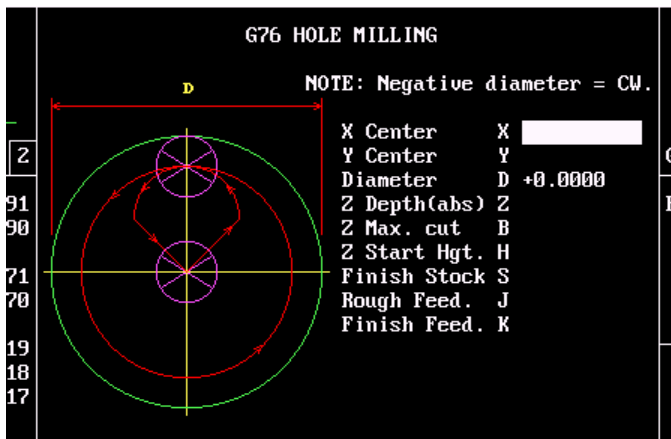

<b>Diameter</b>	<b>D</b>	Diameter of pocket.
<b>Rough Feed</b>	<b>J</b>	Feedrate roughing.
<b>Finish Stock</b>	<b>S</b>	Finish Stock.
<b>Finish Feed</b>	<b>K</b>	Feedrate finish pass.

**Circular pocket G77**

**G77 CIRCULAR POCKET MILLING**  
 NOTE: Negative diameter = CW.

X Center	X	
Y Center	Y	
Z Start Hgt.	H	+0.0000
Z Depth(abs)	Z	+0.0000
Diameter	D	+0.0000
Stepover	A	
Z Max. cut	B	
Rough Feed.	I	
Finish Stock	S	
Finish Feed.	K	
Retract Hgt.	P	

<b>X Center</b>	X	Center X axis.	Optional
<b>Y Center</b>	Y	Center Y axis.	Optional
<b>Z Start Hgt.</b>	H	Start height .1 above surface to be cut into.	
<b>Z Depth (abs)</b>	Z	Absolute Z depth.	
<b>Diameter</b>	D	Diameter of pocket, comp built in.	
<b>Stepover</b>	A	Move over per pass.	Optional
<b>Z Max. cut</b>	B	Max. Z depth per pass.	Optional
<b>Rough Feed.</b>	I	Feedrate roughing.	Optional
<b>Finish Stock</b>	S	Amount of material left for finish pass.	Optional
<b>Finish Feed.</b>	K	Finish pass feedrate.	Optional
<b>Retract Hgt.</b>	P	High return when finished.	Optional

**Rectangular Pocket. G78**

**G78 RECTANGULAR POCKET MILLING**  
 Neg. stepover = CW.

X Center	X	
Y Center	Y	
Length	M	+0.0000
Width	W	+0.0000
Z Start Hgt.	H	+0.0000
Z Depth(abs)	Z	+0.0000
Corner Rad.	U	
Stepover	A	
Z Max. Cut	B	
Ramp Feed.	I	
Rough Feed.	J	
Finish Stock	S	
Finish Feed.	K	
Retract Hgt.	P	

<b>X Center</b>	X	Center of pocket X	
<b>Y Center</b>	Y	Center of pocket Y	
<b>Length</b>	M	Actual length X axis	
<b>Width</b>	W	Actual width Y axis	
<b>Z Start Hgt.</b>	H	.1 above surface to be cut	
<b>Z Depth (abs)</b>	Z	Absolute depth of pocket	
<b>Corner Rad.</b>	U	Radius in corners	
<b>Stepover</b>	A	70% of cutter or less	
<b>Z Max. Cut</b>	B	Max depth per pass	
<b>Ramp Feed</b>	I	Feedrate on 3 axis first move	
<b>Rough Feed</b>	J	Feedrate for roughing	
<b>Finish Stock</b>	S	Amount of stock for finish cut	
<b>Finish Feed</b>	K	Finish feedrate	
<b>Retract Hgt.</b>	P	Retract after finished.	

**Area Clearance G169.**

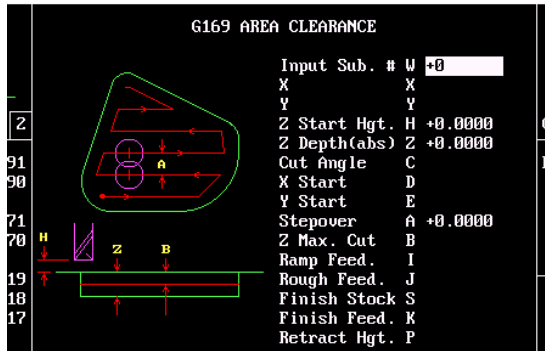

<b>Input Sub #</b>	<b>W</b>	Subroutine number.
<b>X</b>	<b>X</b>	X position tool will Z down into part
<b>Y</b>	<b>Y</b>	Y position tool will Z down into part
<b>Z Start Hgt.</b>	<b>H</b>	Start height .1 above top of pocket
<b>Z Depth (abs)</b>	<b>Z</b>	Total depth of pocket absolute
<b>Cut Angle</b>	<b>C</b>	Used if starting in middle of radius
<b>X Start</b>	<b>D</b>	Position of cut at start X axis. Optional
<b>Y Start</b>	<b>E</b>	Position of cut at start Y axis. Optional
<b>Stepper</b>	<b>A</b>	Cutter stepper each pass
<b>Z Max. Cut</b>	<b>B</b>	Max depth of cut per pass.
<b>Ramp Feed</b>	<b>I</b>	Ramp feedrate Z down
<b>Rough Feed</b>	<b>J</b>	Rough feedrate
<b>Finish Stock</b>	<b>S</b>	Stock left for finish pass
<b>Finish Feed</b>	<b>K</b>	Finish feedrate
<b>Retract Hgt.</b>	<b>P</b>	Retract after finished.

**Mold Rotation G45**

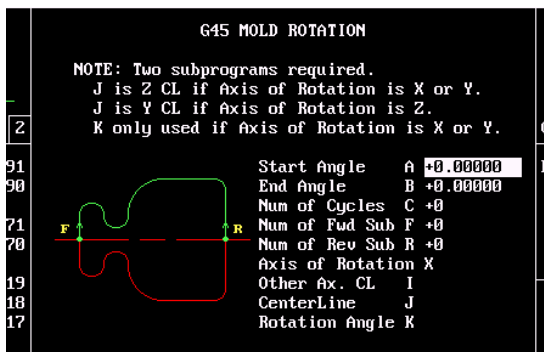

<b>Start Angle</b>	<b>A</b>	Angle where rotation is going to start
<b>End Angle</b>	<b>B</b>	Angle where rotation is going to end
<b>Num of Cycles</b>	<b>C</b>	1 cycle equals 1 Fwd and 1 Rev. Sub.
<b>Num of Fwd Sub</b>	<b>F</b>	Sub. Profile forward direction
<b>Num of Rev Sub</b>	<b>R</b>	Sub. Profile Reverse direction
<b>Axis of Rotation</b>	<b>X</b>	Axis rotation is around X,Y or Z
<b>Other axis CL</b>	<b>I</b>	Center line X or Y if not Zero
<b>Centerline</b>	<b>J</b>	Center line Z Axis if not Zero
<b>Rotation Angle</b>	<b>K</b>	Angle rotation Z axis only

### Elbow Milling G49

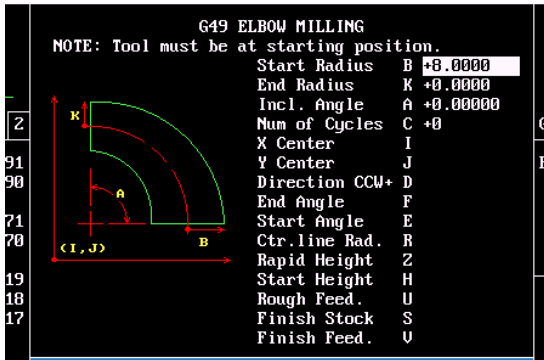

<b>Start Radius</b>	<b>B</b>	Radius at start of Elbow
<b>End Radius</b>	<b>K</b>	Radius at end of Elbow
<b>Included Angle</b>	<b>A</b>	Included angle
<b>Num of Cycles</b>	<b>C</b>	Sub. Profile forward direction
<b>X Center</b>	<b>I</b>	Sub. Profile Reverse direction
<b>Y Center</b>	<b>J</b>	Axis rotation is around X,Y or Z
<b>Direction CCW+</b>	<b>D</b>	Center line X or Y if not Zero
<b>End Angle</b>	<b>F</b>	Center line Z Axis if not Zero
<b>Start Angle</b>	<b>E</b>	Angle rotation Z axis only
<b>Ctr. Line Radius</b>	<b>R</b>	Radius at center of elbow
<b>Rapid Height</b>	<b>Z</b>	Starting height above surface.
<b>Start Height</b>	<b>H</b>	Z height to start
<b>Rough Feed</b>	<b>U</b>	Rough feedrate
<b>Finish Stock</b>	<b>S</b>	Amount of stock for finish pass
<b>Finish Feed</b>	<b>V</b>	Feedrate for finish cut

### Draft Pocket G73

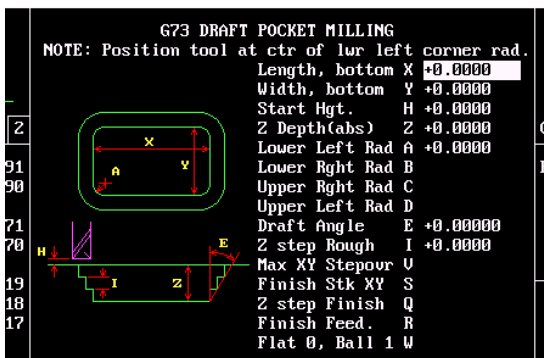

<b>Length, bottom</b>	<b>X</b>	Length at bottom of pocket.	required
<b>Width, bottom</b>	<b>Y</b>	Width at bottom of pocket.	required
<b>Start Height</b>	<b>H</b>	Height above part to rapid.	required
<b>Z Depth (abs)</b>	<b>Z</b>	Absolute depth	required
<b>Lower Left Rad.</b>	<b>A</b>	Lower left Radius	required
<b>Lower Right Rad.</b>	<b>B</b>	Lower right radius	optional
<b>Upper Left Rad.</b>	<b>C</b>	Upper left radius	optional
<b>Upper Right Rad.</b>	<b>D</b>	Upper right radius	optional
<b>Draft Angle</b>	<b>E</b>	Draft angle Degrees	required
<b>Z step Rough</b>	<b>I</b>	Depth per pass in Z axis	required
<b>Max XY Steppour</b>	<b>V</b>	Maximum steppour XY	optional
<b>Finish Stock XY</b>	<b>S</b>	Finish stock XY	optional
<b>Z step Finish</b>	<b>Q</b>	Z step finish pass	optional
<b>Finish Feed</b>	<b>R</b>	Finish feedrate	optional
<b>Flat 0, Ball 1</b>	<b>W</b>	Flat mill = 0 Ball mill = 1	optional

**Note:** Tool must be positioned at center of radius bottom left corner. Center of pocket must be cleared before using this cycle. When using flat endmill will go to programmed depth. If ball endmill uses will only go to depth minus cutter radius, .5 mill Absolute depth -1 actual depth it would go to is -.75.

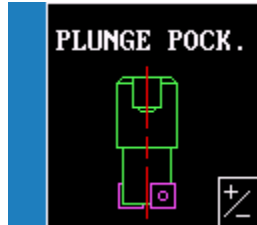

High lite plunge pockets press

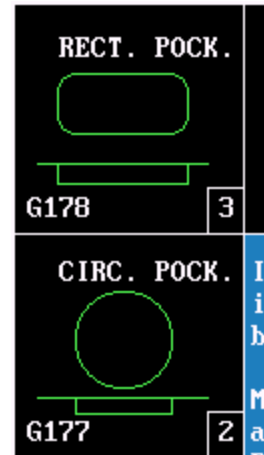

**Plunge Circular Pocket G177**

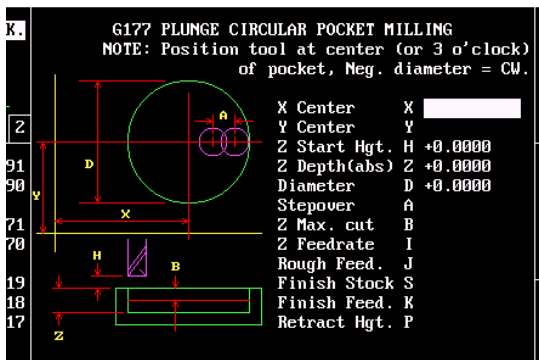

<b>X Center</b>	<b>X</b>	Center X axis	Optional
<b>Y Center</b>	<b>Y</b>	Center Y axis. Same as above.	Optional
<b>Z Start Hgt.</b>	<b>H</b>	Start height .1 above surface to be cut.	
<b>Z Depth (abs)</b>	<b>Z</b>	Absolute Z depth.	
<b>Diameter</b>	<b>D</b>	Diameter of pocket, comp built in.	
<b>Stepover</b>	<b>A</b>	Move over per pass.	Optional
<b>Z Max. cut</b>	<b>B</b>	Max. Z depth per pass.	Optional
<b>Z Feedrate</b>	<b>I</b>	Feedrate plunging	Optional
<b>Rough Feed.</b>	<b>J</b>	Feedrate roughing.	Optional
<b>Finish Stock</b>	<b>S</b>	Amount of material left for finish pass.	Optional
<b>Finish Feed.</b>	<b>K</b>	Finish pass feedrate.	Optional
<b>Retract Hgt.</b>	<b>P</b>	High return when finished.	Optional

**Plunge Pocket Pocket G178**

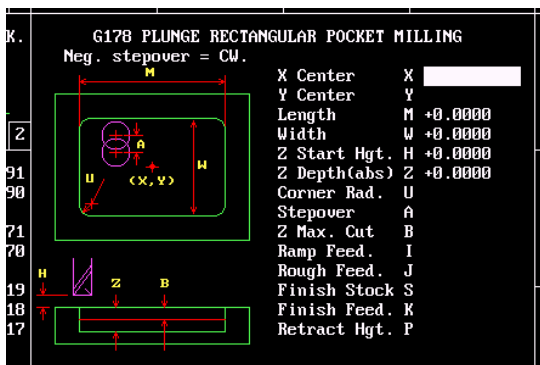

<b>X Center</b>	<b>X</b>	Center of pocket X
<b>Y Center</b>	<b>Y</b>	Center of pocket Y
<b>Length</b>	<b>M</b>	Actual length X axis
<b>Width</b>	<b>W</b>	Actual width Y axis
<b>Z Start Hgt.</b>	<b>H</b>	.1 above surface to be cut
<b>Z Depth (abs)</b>	<b>Z</b>	Absolute depth of pocket
<b>Corner Rad.</b>	<b>U</b>	Radius in corners
<b>Stepover</b>	<b>A</b>	70% of cutter or less
<b>Z Max. Cut</b>	<b>B</b>	Max depth per pass
<b>Ramp Feed</b>	<b>I</b>	Feedrate on 3 axis first move
<b>Rough Feed</b>	<b>J</b>	Feedrate for roughing
<b>Finish Stock</b>	<b>S</b>	Amount of stock for finish cut
<b>Finish Feed</b>	<b>K</b>	Finish feedrate
<b>Retract Hgt.</b>	<b>P</b>	Retract after finished.



## Pockets with Islands (G162)

**Format:** G162 An Bn Cn Dn En

This cycle allows islands in irregular pockets. The main pocket must be the lowest subroutine number. Normally, this would be one (1). Pockets with Islands can be programmed using:

- DXF (see “Section 17, Using DXF for Pockets with Islands (G162)”)
- CAM (see “Section 18, Example #12 Using CAM for Pockets with Islands (G162)”)
- Subroutines

More than one **G162** Island cycle can be programmed at a time. They may be strung together, but on separate lines. Islands can be programmed inside of islands. Five islands can be put on a line. The shape number subroutine number is used as inputs..

Refer to

**Table 5-21.**

Activate a tool prior to programming G78, so cutter diameter is known.

**Table 5-21, G162 Address Words**

Address Word	Description
A	First island. Required.
B	Second island. Optional.
C	Third island. Optional.
D	Fourth island. Optional.
E	Fifth island. Optional.

### Using Subroutines for Pockets with Islands

The program below is the same one used in the DXF portion with subroutines added for the letters. In the third G162 some of the numbers have negative sign (-) in front of them, this changes the side of the cutter comp for the islands in islands. See **Figure 5-13, Subroutines Pockets with Islands Example Workpiece** and **Table 5-22, Pockets with Islands Subroutines Programming Example**.

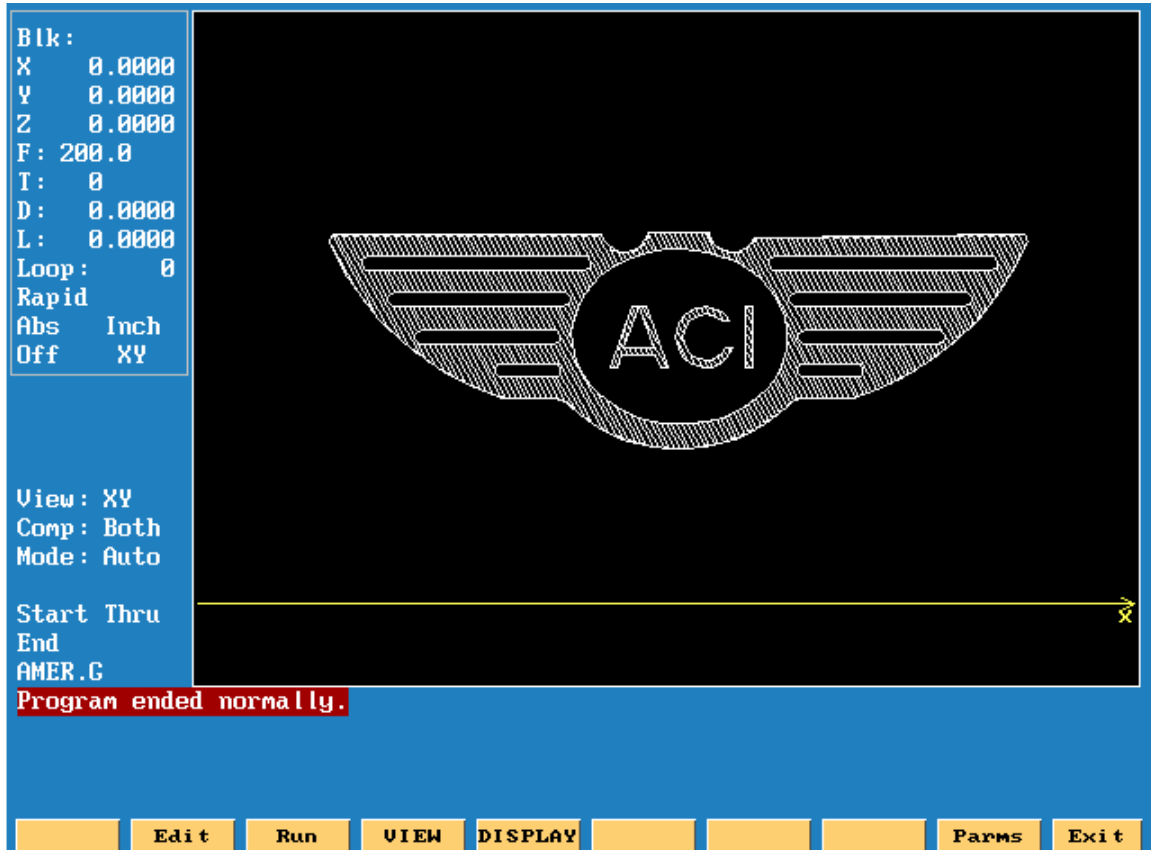
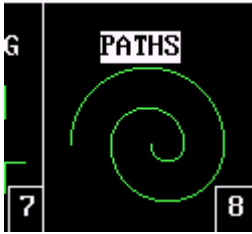



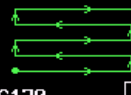



Figure 5-13, Subroutines Pockets with Islands Example Workpiece

Table 5-22, Pockets with Islands Subroutines Programming Example

N1	G00 G17 G70 G90
N2	T1D.0205 L-1 M6
N3	S1250M3
N4	M8
N5	G53O01
N6	G162 A2 B3 C4 D5 E6
N7	G162 A7 B8 C9 D10
N8	G162 A-11 B12 C-13 D-14
N9	G169 W1 H0.1 Z-0.0050 C299. A0.0080 I5.0 J12.0 S0.0010 K10.0 P1
N10	M2
N11	
N12	O11
N13	X1.1044 Y0.5
N14	Z0.1
N15	G01 Z-0.005
N16	G01 X1.159 Y0.65
N17	X1.2052

N18	X1.2598 Y0.5
N19	X1.2226
N20	X1.2135 Y0.525
N21	X1.1507
N22	X1.1416 Y0.5
N23	X1.1044
N24	G00 Z0.1
N25	M99
N26	
N27	
N28	O12
N29	X1.1634 Y0.56
N30	Z0.1
N31	G01 Z-0.005
N32	G01 X1.1821 Y0.6112
N33	X1.2007 Y0.56
N34	X1.1634
N35	G00 Z0.1
N36	M99
N37	
N38	O13
N39	X1.4007 Y0.55
N40	Z0.1
N41	G01 Z-0.005
N42	G01 X1.3612
N43	G02 Y0.6 I0.0312 J0.025
N44	G01 X1.4007
N45	G03 Y0.55 I0.0707 J-0.025
N46	G00 Z0.1
N47	M99
N48	
N49	O14
N50	G0 X1.42Y.5
N51	G1 X1.42Y.65
N52	G1 X1.460 Y.65
N53	G1 X1.460 Y.5
N54	G1 X1.42 Y.5
N55	M99



<p>SPIRAL</p>  <p>G06 3</p>		<p>FACING</p>  <p>G170 5</p>		<p>CIRC PROFILE</p>  <p>G171 7</p>	<p>RECT PROFILE</p>  <p>G172 8</p>
<p>ELLIPSE</p>  <p>G05 2</p>	<p>If they are not active, from group 1 Plane, inch/metric, and absolute/incremental can be selected.</p> <p>Move the cursor around the screen with the arrow keys or by number required.</p>				

- #2. Ellipse. Produces an ellipse, uses special cutter comp.
- #3. Spiral. Will cut a tapered thread.
- #5. Facing. Faces large surfaces.
- #7. Circular Profile. Cut circle either inside or outside.
- #8. Rectangular Profile. Cut rectangle inside or outside.

### Ellipse G05

**Note:** All dimensions are INCREMENTAL.

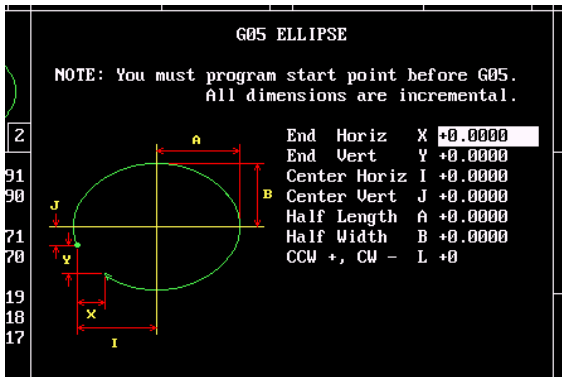

<b>End Horizontal</b>	<b>X</b>	Distance from start to end X axis.
<b>End vertical.</b>	<b>Y</b>	Distance from start to end Y axis.
<b>Center Horizontal</b>	<b>I</b>	Distance to center from start.
<b>Center Vertical</b>	<b>J</b>	Distance to center from start.
<b>Half length</b>	<b>A</b>	Half length of ellipse x axis
<b>Half width</b>	<b>B</b>	Half width of ellipse Y axis.
<b>CCW +,CW -.</b>	<b>L</b>	Direction of cut.

Cutter comp for ellipse uses **M1040** X0 = off, X1 = outside and X2 = inside.  
Cutter must be positioned in compensated position before ellipse is programmed.

### Spiral G06

**Note:** All dimensions are INCREMENTAL.

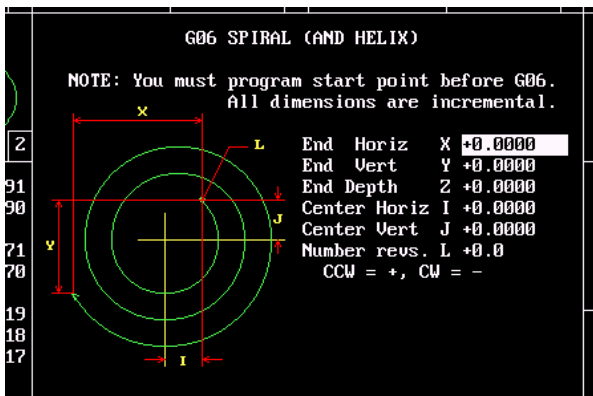

<b>End Horizontal</b>	<b>X</b>	Distance from start to end X axis.
<b>End vertical.</b>	<b>Y</b>	Distance from start to end Y axis.
<b>End Depth Z</b>	<b>Z</b>	Distance from start to end Z axis.
<b>Center Horizontal</b>	<b>I</b>	Distance to center from start.
<b>Center Vertical</b>	<b>J</b>	Distance to center from start.
<b>Number of revolution</b>	<b>L</b>	Number of turn it will make.
<b>CCW +,CW -.</b>		Direction of cut.

No compensation available for spiral.

## Facing G170

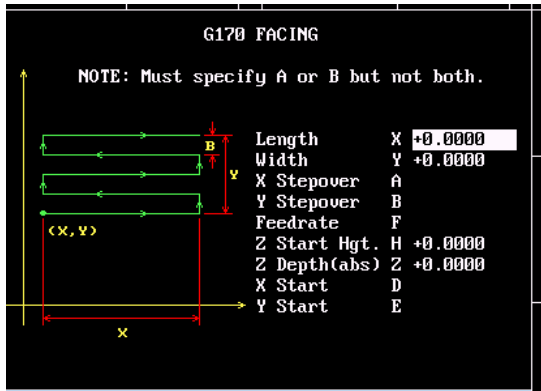

<b>Length</b>	<b>X</b>	Incremental length X axis.
<b>Width</b>	<b>Y</b>	Incremental width Y axis.
<b>X Stepover</b>	<b>A</b>	Stepover X .
<b>Y Stepover</b>	<b>B</b>	Stepover Y.
<b>Feedrate</b>	<b>F</b>	Feedrate.
<b>Z Start hieght</b>	<b>H</b>	Start height .1 above surface.
<b>Z Depth Absolute</b>	<b>Z</b>	Finish depth.
<b>X Start</b>	<b>D</b>	Start X axis.
<b>Y Start</b>	<b>E</b>	Start Y axis.

**Note:** Only A or B not both can be used.  
Cutter will step away from start corner by half the cutter diameter.

**Circular profile G171**

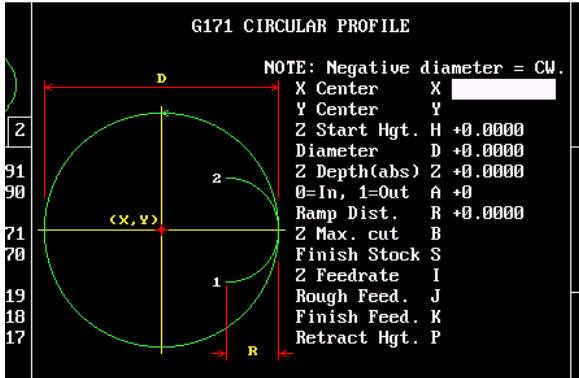

- Center X.** X X Center (optional).
- Center Y.** Y Y Center (optional).
- Start height.** H Start height above surface to be cut.
- Diameter.** D Diameter of pocket (actual).
- Z depth (absolute).** Z Depth to be cut (absolute).
- 0 = inside, 1 = outside.** A 0 inside ,1 outside of circle.
- Ramp Distance.** R Size of ramp on radius.
- Z Maximum cut.** B Maximun depth in Z per pass.
- Finish Stock.** S Amount of stock left for finish cut.
- Z Feedrate.** I Feedrate in Z axis.
- Rough feedrate.** J Feedrate for roughing.
- Finish Feedrate.** K Feedrate for finishing.
- Retract height.** P High retract if higher than H value.

**Rectangular Profile G172**

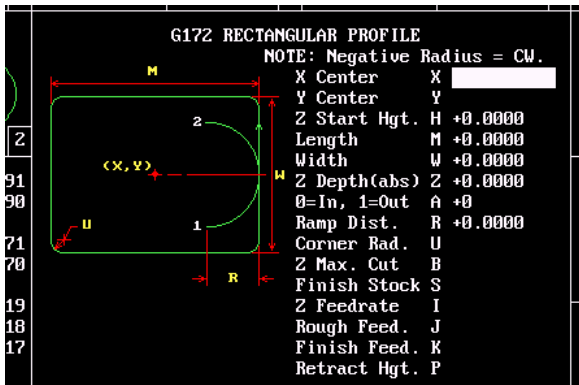

- Center X.** X X Center (optional).
- Center Y.** Y Y Center (optional).
- Start height.** H Start height above surface to be cut.
- Length** M Length of pocket X axis (actual).
- Width..** W Width of pocket Y axis (actual)
- Z depth (absolute).** Z Depth to be cut (absolute).
- 0 = inside, 1 = outside.** A 0 inside ,1 outside of circle.
- Ramp Distance.** R Size of ramp on radius.
- Corner radius** U Radius in corners.
- Z Maximum cut.** B Maximun depth in Z per pass.
- Finish Stock.** S Amount of stock left for finish cut.
- Z Feedrate.** I Feedrate in Z axis.
- Rough feedrate.** J Feedrate for roughing.
- Finish Feedrate.** K Feedrate for finishing.
- Retract height.** P High retract if higher than H value.

## Thread Mill Cycle (G181)

**Format:** G181 Xn Yn Zn Hn Pn Dn Cn Bn Rn Sn En Jn Kn Vn

**WARNING:** The first move in this cycle is a rapid move to the center of the thread before moving the Z axis. Make sure the tool is properly located before calling up this cycle.





Use the thread milling for cutting inside or outside threads. It will cut either Inch or MM, left or right hand, and Z movement up or down. A single tooth or multi-toothed tool may be used. Start can be at the top or bottom of the hole or boss. The tools are set, as you would normally set TLO.

### Programming the Thread Mill Cycle

To program the Thread Mill Cycle:

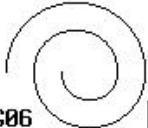
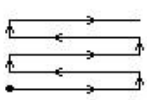
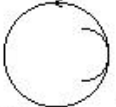
1. In Edit mode, press **Help (F1)**, select **PATHS** from the menu, then **"THREAD MILL"** to display the G181 Thread Mill pop-up menu (refer to **Figure 5-20**).
2. Complete the entry fields (refer to **Table 5-28, G181 Address Words**), and press **EXIT (F10)**.

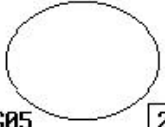
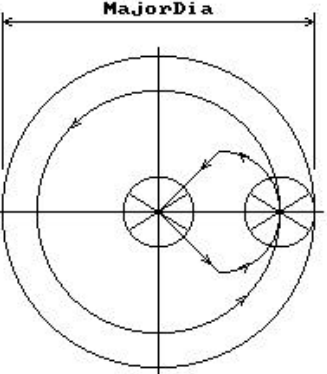
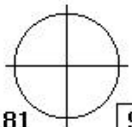
Depending on the parameters used and their values, when cutting a thread, the tool can ramp into the cut as illustrated in **Figure 5-20**. See **Table 5-28, G181 Address Words**.

 <b>SPIRAL</b> G06 3	 <b>FACING</b> G170 5	 <b>CIRC PROFILE</b> G171 7	 <b>RECT PROFILE</b> G172 8
 <b>ELLIPSE</b> G05 2  Incr. G91 Absolute G90  MM G71 Inch G70  YZ Plane G19 XZ Plane G18 XY Plane G17  Feed G1 Rapid G0 1	<b>G181 THREAD MILL</b> X, Y, Z, H & P are all absolute D, - = Ccw, + = Cw C, Thread Depth, + = Inside Thread - = Outside 		 <b>THREAD MILL</b> G181 9  <b>SPIN PROBING</b>  +/  <b>TOOL PROBING</b>  .
G181 Z0.0000 H0.0000 P0.0000 D0.0000 C0.0000 B0.0000			

THREADMILLPU

**Figure 5-20, Thread Mill Pop-up Menu**



Table 5-28 describes the Thread Mill Cycle entry fields.

Table 5-28, G181 Address Words

Address Word	Description
<b>X</b>	Absolute X coordinate of the center of the thread. If no coordinate is entered, the CNC puts the center of thread at the current tool position. (Optional)
<b>Y</b>	Absolute Y coordinate of the center of the thread. If no coordinate is entered, the CNC puts the center of thread at the current tool position. (Optional)
<b>Z</b>	Absolute Z position where the thread cut will finish. This can be above or below the start position depending on the direction of the thread cut: up or down. (Required)
<b>H</b>	Absolute Z position where the thread cut starts. This can be above or below the finish position depending on the direction of the thread cut, up or down. If not set, cycle will use the current Z tool position. (Optional)
<b>P</b>	An Absolute safe Z position above the part for rapid moves in X and/or Y. (Required) <b>Warning: P must be above the part to avoid a crash while positioning.</b>
<b>D</b>	Major thread Diameter. If this is a tapered thread, it is the major diameter at the Z start position. Hence, if you have a tapered hole and you start at the top and cut down, you would have a different major diameter than if you started at the bottom and cut up. A plus (+) value cuts in the CW direction and a minus (-) value cuts in the CCW direction. (Required)
<b>C</b>	Depth of thread. The incremental depth of thread on one side. A plus (+) value is inside thread, a minus (-) value is outside thread. (Required)
<b>B</b>	Threads per inch (TPI) or lead of thread in MM. Note: The minimum number of threads per inch is "1". (Required)
<b>R</b>	Size of radius arcing into start of thread. (Optional) <b>Note:</b> If <b>R</b> is a positive value or not set and the thread is "inside", the cycle will always return to the center between passes. If <b>R</b> is a negative value, the cutter will move to the start or end point that is closest to the center if inside thread, and farthest away from center if outside thread. If <b>R</b> is not specified at all and the thread is outside, the cutter will back away from the largest diameter by an amount equal to the thread depth.
<b>S</b>	Amount to leave for a finish pass after the roughing passes. (Optional)
<b>E</b>	Number of roughing cuts to be taken. (Optional) <b>Note:</b> If "Stock" is not set or set to zero and <b>E</b> is 1 or 0, the cycle will make just one pass at the full depth. If "Stock" is set to greater than zero and <b>E</b> is 1 or 0, the cycle will make one pass at the stock depth and one pass at full thread depth. <b>Note:</b> If you would like all non-cutting positioning moves to be rapid, set <b>E</b> to a negative number.

(Continued...)

**Table 5-28, G181 Address Words**

<b>Address Word</b>	<b>Description</b>
<b>J</b>	Feedrate for roughing. (If not set (blank), the cycle will use the current active feedrate) (Optional)
<b>K</b>	Feedrate for the finish pass. (If not set (blank), the cycle will use the current active feedrate) (Optional)
<b>V</b>	Angle on one side of the thread, (not the included angle). The angle is measured from the right side going counter clockwise with a positive number and clockwise with a negative number. A standard pipe tape with an inside cut would be -1.7833. If not set (blank), than the thread is straight. (Optional)

Tool Length Offset is set the same as with any other tool or operation. A tool diameter also has to be set in the tool table, as cutter compensation is built into this cycle (cutter compensation is not allowed during the use of this cycle).

If X and Y are not programmed, position tool center of the thread before the G181 line:

- X and Y will rapid to the starting position of the thread.
- Z will rapid to the safe height specified in "P".
- The Z axis will feed down to the start cut position "H". This could be above or below the Z position specified in the "Z" finish position.
- Depending on what is in the "R" parameter the tool will arc into the first cut position.
- Spiral up or down, depending on the difference between "Z" and "H" and go counterclockwise or clockwise depending if "D" is plus or minus.
- Then arc-out and feed to the thread center for inside threads or a safe distance away from the thread for outside threads depending on the value in "R".
- Then feed back to the "H" height.
- Then feed X and Y to the next depth of cut. The depth of each roughing pass will be the thread depth specified in the "C" parameter minus the stock amount specified in the "S" parameter, divided by the number of roughing passes specified in the "E" parameter.
- The cycle repeats this process until the final finish pass.
- It will then cut the thread at the full thread major diameter.

When cutting a taper on an inside thread, care should be taken. An error will be generated if the diameter on the small end of the taper becomes too small for the tool to fit along with arc in and out moves. Not entering and arc-in value in the "R" parameter will allow the cycle to move to the center of the hole for maximum clearance.







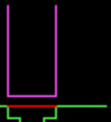

### Sample Thread Milling Cycle Program

```
1    G0 G90 G70 G17
2    T1 M6
3    S2000 M3
4    X0 Y0
5    G181 Z-1. H0.1 P.5 D1. C.0625 B8. R.1 S.002 E2 J20.0 K5.0
6    Z5
7    M5
8    M2
```

With a cutter diameter of 0.625, this program will cut a 1-8 inside thread at X0 Y0. The tool will spiral down the thread pitch of 8 threads per inch, finishing at a depth of -1. The starting height is 0.1, the safe rapid Z height is 0.5, the major thread diameter is 1 inch, and depth of thread is 0.0625. The arc-in radius is 0.1 and the stock amount for the finish pass is 0.002. The rough feedrate is 20.0 and the finish feedrate is 5.0.

**Note:** If you would like all non-cutting positioning moves to be rapid, set "E" to a negative number. The idea is to initially set "E" as a positive number and after proving out the program, change "E" to a negative number for faster production. If you only need one pass to size and you want the positioning moves to be rapid, set "E" to -1.

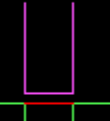
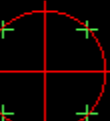
**Drilling Cycles G80 Series**

 <p>COUNTERBORE</p> <p>G82</p>	 <p>PECKING</p> <p>G83</p>	 <p>TAPPING</p> <p>G84</p>	 <p>BORE/BI</p> <p>G85</p>	 <p>BORE/UNI</p> <p>G86</p>	 <p>CHIP BREAK</p> <p>G87</p>
 <p>DRILLING</p> <p>G81</p>	<p>If they are not active, from group 1 Plane, inch/metric, and absolute/incremental can be selected.</p> <p>Move the cursor around the screen with the arrow keys or by number required.</p> <p>Press SELECT key to pick the item. Combinations of items are not allowed in the same block and if selected, an error message will be displayed.</p> <p>Press ACCEPT to insert data into the program and remain in Help, press EXIT to insert data into the program and return to the Editor.</p> <p>All of the G80 series cycles are modal and will activate the Z axis at each X,Y coordinate until canceled with a G80 code.</p> <p>NOTE: Must program drill cycle before bolt circle.</p>				 <p>FLAT BORE</p> <p>G89</p>
<p>Incr. G91</p> <p>Absolute G90</p> <p>MM G71</p> <p>Inch G70</p> <p>YZ Plane G19</p> <p>XZ Plane G18</p> <p>XY Plane G17</p>					 <p>BOLT CIRCLE</p> <p>G79</p>
<p>CANCEL G80</p>					 <p>PATTERN</p> <p>G179</p>

↑
↓
Text
Select
Abort
Accept
Prev
Exit

**Note:**That there is now a **G80** in the first box on left.

All **G80** cycles must be turn OFF with a **G80** as soon as drill operation is finished.

### Basic Drilling Cycles G81

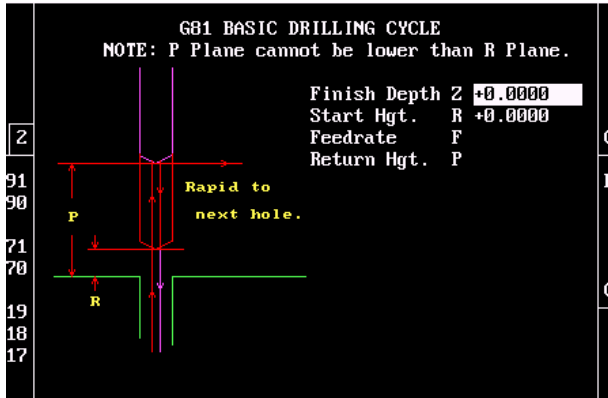

- Finish Depth.** Z Finish depth of hole.
- Start Hgt.** R Start height above surface to be drilled.
- Feedrate.** F Feedrate for drilling.
- Return Hgt.** P Return height if higher than R plane.

### Counter Boring Cycles G82

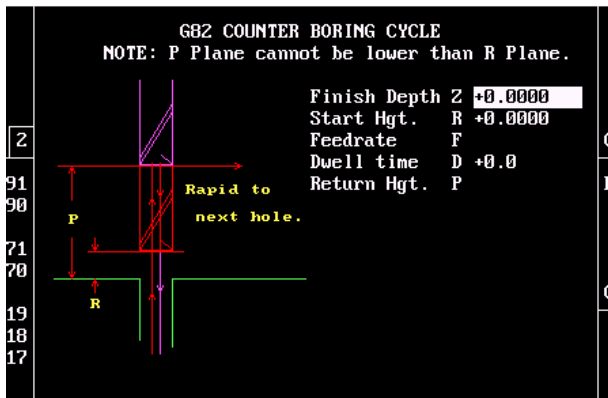

- Finish Depth.** Z Finish depth of hole.
- Start Hgt.** R Start height above surface to be drilled.
- Feedrate.** F Feedrate for drilling.
- Dwell time** D Dwell time qat bottom of hole.
- Return Hgt.** P Return height if higher than R plane.

### Peck Drilling Cycles G83

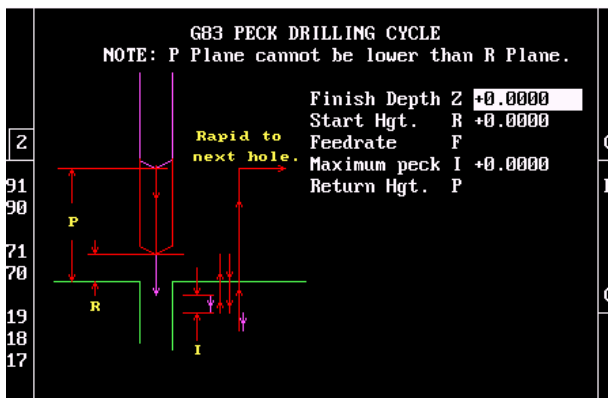

- Finish Depth.** Z Finish depth of hole.
- Start Hgt.** R Start height .1 above surface to be drilled.
- Feedrate.** F Feedrate for drilling.
- Maximun Peck** I Maximun peck before retracting.
- Return Hgt.** P Return height if higher than R plane.

### Tapping Cycles G84

**G84 TAPPING CYCLE**  
 NOTE: P Plane cannot be lower than R Plane.  
 S: 0 = Spindle sync. OFF, 1 = ON.  
 Program TPI in Inch or Lead in MM.  
 Spindle RPM must be programmed.

2  
91  
90  
71  
70  
19  
18  
17

Finish Depth Z +0.0000  
 Start Hgt. R +0.0000  
 TPI/Lead F +0.0000  
 Spindle S  
 Return Hgt. P  
 Dwell time D

- Finish Depth.** Z Finish depth of hole.
- Start Hgt.** R Start height above surface to be drilled.
- TPI/Lead.** F TPI if inch/Lead if MM.
- Spindle.** S Spindle sync. 0 = OFF, 1 = ON
- Return Hgt.** P Return height if higher than R plane.
- Dwell time** D Dwell at bottom if necessary.

### Boring Cycles G85

**G85 BORING CYCLE**  
 NOTE: P Plane cannot be lower than R Plane.

2  
91  
90  
71  
70  
19  
18  
17

Finish Depth Z +0.0000  
 Start Hgt. R +0.0000  
 Feedrate F  
 Return Hgt. P

- Finish Depth.** Z Finish depth of hole.
- Start Hgt.** R Start height above surface to be drilled.
- Feedrate.** F Feedrate for drilling.
- Return Hgt.** P Return height if higher than R plane.

### Boring Cycles One Direction G86

**G86 BORING IN ONE DIRECTION**  
 NOTE: P Plane cannot be lower than R Plane.

2  
91  
90  
71  
70  
19  
18  
17

Finish Depth Z +0.0000  
 Start Hgt. R +0.0000  
 Feedrate F  
 X Backoff I  
 Dwell time D  
 Return Hgt. P  
 Index Angle C

- Finish Depth.** Z Finish depth of hole.
- Start Hgt.** R Start height above surface to be drilled.
- Feedrate.** F Feedrate for drilling.
- X Backoff.** I Backoff before retracting from hole.
- Dwell time.** D Dwell to flat bottom hole.
- Return Hgt.** P Return height if higher than R plane.
- Index Angle.** C Index angle to orient spindle to backoff.

### Chip Breaking Cycle G87

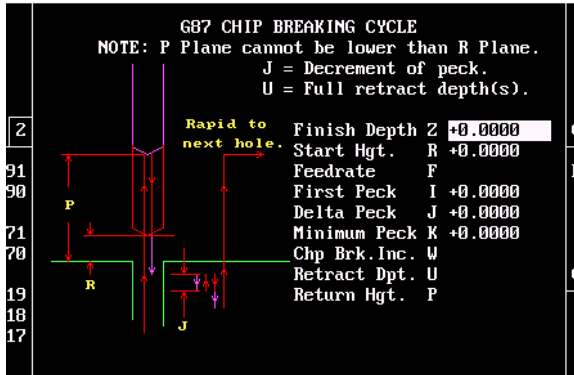

- Finish Depth.** Z Finish depth of hole.
- Start Hgt.** R Start height .1 above surface to be drilled.
- Feedrate.** F Feedrate for drilling.
- First Peck.** I Amount of first peck.
- Delta Peck.** J Amount to decrease peck each peck.
- Minimum Peck.** K Smallest peck amount.
- Chp. Brk. Inc.** W Retract for chip break
- Retract Depth.** U Depth full retract accrues.
- Return Hgt.** P Return height if higher than R plane.

### Flat Bottom Boring Cycle G89

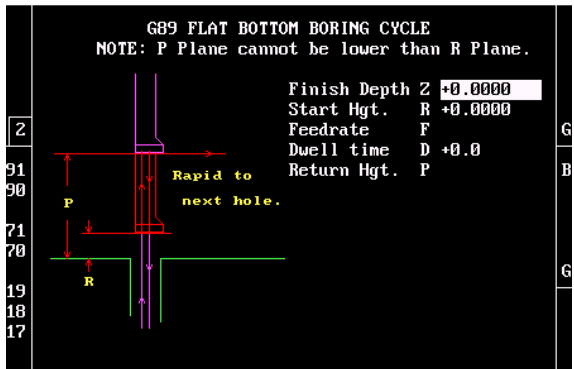

- Finish Depth.** Z Finish depth of hole.
- Start Hgt.** R Start height above surface to be drilled.
- Feedrate.** F Feedrate for drilling.
- Dwell.** D Dwell in second at bottom of hole.
- Return Hgt.** P Return height if higher than R plane.

### Bolt Hole Circle Drilling G79

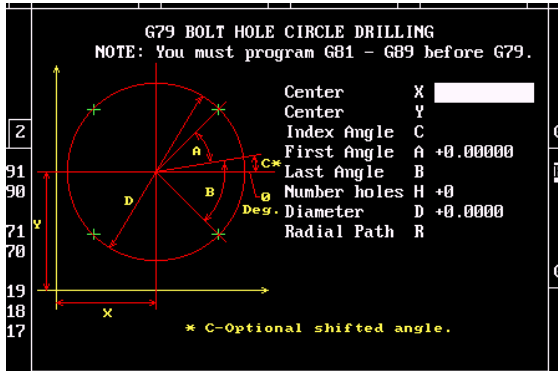

- Center.** X Center X axis.
- Center.** Y Center Y axis.
- Index Angle.** C Angle to rotate 0 angle from 3 o'clock.
- First Angle.** A Angle of first hole from 0.
- Last Angle.** B Angle of last hole, if full pattern not required.
- Number Holes.** H Number of holes to drill.
- Diameter.** D Diameter of pattern.
- Radial Path.** R If 1 is entered will move radially around pattern

### Hole Pattern Dilling G179

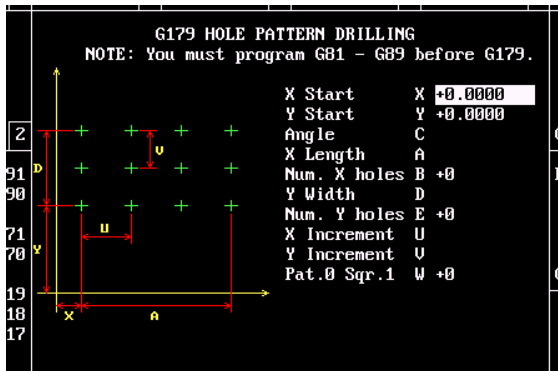

- X Start.** X Start point X axis.
- Y Start.** Y Start point Y axis.
- Angle.** C Angle If pattern is rotated.
- X Length.** A Distance from first to last hole X axis.
- Y Width** B Distance from first to last hole Y axis.
- Num. Holes X.** D Number of holes X axis.
- Num. Holes Y.** E Number of holes Y axis.
- X Increment.** U Distance between holes X axis.
- Y Increment.** V Distance between holes Y axis.
- Pat.=0 Sqr.=1** W Pattern as shown or square around outside.

Use D & E or U & W not both.



## G-Code without Graphics

MISCELLANEOUS G CODES	
G04 Dwell.	←
G09 Exact Stop (Single Block).	←
G22 Stroke Limit.	←
G28 Reference Point Return.	←
G29 Return from Reference Point.	←
G53 Fixture Offset(s) (Coord. Syst. Select)	←
G61 Exact Stop Mode (Contouring Mode OFF).	←
G64 Contouring Mode (Exact Stop Mode OFF).	←
G65 Macro Call, Single (Non-Modal)	←
G66 Macro Call, Modal.	←
G67 Cancel Modal Macro	←
G92 Preset Zero.	←
G94 Per Minute Feed	←
G95 Per Revolution Feed.	←

**Dwell** In seconds with Tn  
**Exact stop** will stop exactly in position one shot.  
**Stroke Limit** set a box that tool cannot move outside or inside.  
**Reference Point Return** sends machine home in designated axis.  
**Reference Point Return**  
**Fixture offset** Absolute zero shift from Home.  
**Exact Stop** will stop after each move to get into exact position.  
**Contouring Mode** continuous path no stops between moves.  
**Macro Call** one shot user written macro.  
**Macro Call** modal macro has to be turned off.  
**Cancel Macro** cancel modal macro.  
**Preset Zero** incremental zero shift canceled by G53 or homing.  
**Feed Per Minute** feed in inches per minute.  
**Feed Per Revolution** feed in inches per revolution.

## Miscellaneous M-Codes

M-CODES	
M0 Program Stop.	←
M2 End of Program	←
M3 Spindle ON FWD.	←
M4 Spindle ON REV.	←
M5 Spindle OFF.	←
M8 Coolant ON.	←
M9 Coolant OFF.	←
M30 Jump to New Program.	←
M98 Call Subprogram.	←
M99 End Subprogram.	←
M100 Mirror Image.	←
M105 Dry-Run, All Axes.	←
M106 Dry-Run, NO Z Axis.	←
M107 Dry-Run OFF (Cancel M105, M106)	←

**Program Stop** stop program until START is pressed to to continue.  
**End of Program** end of main program.  
**Spindle ON Forward** turn spindle ON FORWARD.  
**Spindle ON Reverse** turns spindle ON REVERSE.  
**Spindle OFF** turns spindle OFF.  
**Coolant ON** turns coolant ON.  
**Coolant OFF** turns coolant OFF.  
**Jump to New Program** entered using Pxxxx.  
**Call Subroutine** call a subroutine using Pxx.  
**End Subroutine** Last line of subroutine.  
**Mirror Image** axis need to be entered X,Y or Z.M100 turns OFF  
**Dry Run All Axis** display shows motion but no table movement.  
**Dry Run NO Z Axis** X and Y move no Z axis movement.  
**Dry Run OFF** turns OFF dry run.

# ANILAM

## 5000M CNC Control Program Management



**INTRODUCTION**

The Program Directory provides access to all the program management and disk utilities. These functions include Creating, Selecting, Deleting, Undeleting and Copying programs. The Program Directory also provides access to the Floppy Drive utilities.

**Accessing PROGRAM DIRECTORY page.**

(1) From the MANUAL mode press: **Program** The Program files are listed in alphabetical order.

**To access a PROGRAM file from the Program page.**

There are 2 methods to access a particular Program File:

(1) Using the  keys move the High Light to the desired program and Press: **Edit**

or

(2) Press the first letter of the desired program name, this will move the High Light to the first program

name with that letter, then use the  keys to move the High Light to the desired program

and Press: **Edit**

**To CREATE a new Program.**

**NOTE:** There are 2 methods of creating a program file, both are shown below.

**Method No.1** Creating a new program file. From the PROGRAM page:



(1) Press: **Create** At the prompt **NEW PROGRAM: \_** type in the new program name

**NEW PROGRAM: EXAMPLE\_** and Press: 

**NOTE:** Program names can be up to 8 characters in length, but may not include spaces or periods.

**Method No.2** Copying and using an existing program.

If a similar program to that required already exists, it may be copied and given a new name. This allows similarly formatted programs to be used without having to re-type the information.

(1) Using the  keys High Light the existing program to be copied 

Press:  this brings up a menu,  with Copy High Lighted

Press  This will display a second menu  High light Other and Press 

This will bring up a third menu  type in the new program name

“EXAMPLE” and Press  this will create a new program named EXAMPLE and also leave the original program “SAMPLE1.G” intact. This copied program can now be edited to suit the new part. It is not necessary to type the file extension ( .G) as this is completed automatically.

**To change or EDIT an existing program.**



(1) High Light the program to be changed / edited using the  keys.

(2) Press:  to enter the file editor

**To DELETE an existing program.**

(1) High Light the program to be DELTED using the  keys. Press  

(2) To avoid accidental deletion of programs the system requests verification of deletion

 To delete the program Press  

**To UNDELETE / RESTORE a deleted program.**

Should a program become accidentally deleted the following method can be used to restore the program.

NOTE: The restore capability of the system is determined by the space available on the drive. If the space on the drive where the program was stored has been reused restore will not be an available function.

(1) From the PROGRAM page Press:

**Utility**

(2) Using the  keys, High Light Restore  Press 

(3) The system will list any and all programs that are available to be restored. Using the  keys High Light the program to be restored.

(4) Type in the first letter of the program to be restored (the first letter of the program name is lost when a program is deleted).

(5) Press **Cont** if the program can be restored the system will place the program file in its alphabetical location.

**NOTE: ALWAYS CHECK THE VALIDITY OF A PROGRAM AFTER RESTORING. SOME OF THE INFORMATION WITHIN THE PROGRAM MAY HAVE CHANGED.**

**To SELECT a program to run in the AUTO mode.**

Once a program has been created and verified to be correct the operator must SELECT the program to run when in the Auto or Single Step mode.

(1) From the PROGRAM page using the  keys High light the program name.

(2) Press **Select** the selected program to be run will now be displayed in the lower right corner

of the screen.

**Selected Program: EXAMPLE.G**

**To COPY a program to the A: Drive (Floppy Disk).**

The 5000M control uses the C:\ drive and the USER directory to store programs within the system. When in the PROGRAM directory the drive and directory are displayed in the lower left corner of the screen.



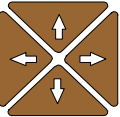

The 5000M uses the A:/ drive for the Floppy Disk Drive. Programs may be copied to or copied from the Floppy Drive individually or in multiples.

(1) From the PROGRAM directory use the  keys to High light the program to be copied to the A:\ (Floppy Disk) drive. (Place a floppy disk in the A:\ floppy disk drive unit).

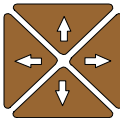
(2) If multiple programs are to be copied High light the first program to be copied using the  keys

and Press  Then using the  keys again High light the next program to be copied and

Press  Continue until all programs to be copied are High lighted. 

(3) When all programs to be copied are High light Press 



(4) With Copy Hi-lited  Press 

(5) This brings up a menu  With A: High lighted Press

The lower left corner of the screen displays COPYING.... while the program is copied. The procedure is complete when COPYING.... is no longer displayed.

**To COPY a program from the A: Drive (Floppy Disk) to the Program Directory C:\USER**

The 5000M uses the A:/ drive for the Floppy Disk Drive. Programs may be copied to or copied from the Floppy Drive individually or in multiples. To view or copy the programs on a Floppy Disk, the operator must first LOG to the Floppy disk Drive (A:\)



(1) From the PROGRAM directory Press  (Shift) this will change the descriptions of the F keys, Press  This shows a menu of the drives that the operator can view on screen.

(2)  High light A: and Press  the programs on the Floppy Dive (A:\) will now

be displayed.

(3) Use the  keys to High light the program(s) to be copied to the Program Directory (C:\)

If multiple programs are to be copied High light the first program to be copied using the  keys

and Press  Then using the  keys again High light the next program to be copied and

Press  Continue until all programs to be copied are High lighted.

(4) When all programs to be copied are High lighted Press 

(5) With Copy High lighted  Press  A menu is show 



With C: High lighted Press  The lower left corner of the screen displays COPYING. while the program(s) are copied. The procedure is complete when COPYING.... is no longer displayed.

**Continued....**

To return to the Program Directory , LOG back to C:\USER

(1) Press  (Shift) this will change the descriptions of the F keys,

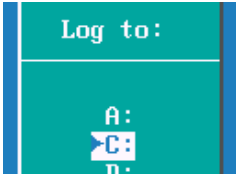
(2) Press  This shows a menu of the drives that the operator can view on screen.

(2)  High light C: and Press  the C:\USER (lower left corner of the screen)

will now be displayed.

**To COPY program files to the A: (Floppy Disk) when using the CAM**

When using the CAM Editor to write programs the 5000M system will create additional program files, and ALL these files MUST BE COPIED to ensure correct operation of the program.

The program name to which the CAM is to be associated MUST be High lighted prior to entering CAM or (F4 from the Program Directory). this program will have extension of **.G**

The correct program must be high light because upon entering the CAM , the system creates a file with the same name as the program but with an extension of **.CAM** and also a file with the extension of **.GEO** These files are used to record the CAM (.CAM file) settings inside the CAM and also to record the GEOMETRICAL ELEMENTS created (.GEO file).

Once a Shape has been created a 3rd file is also created, this file will have an extension of **.1**

NOTE: If more than one Shape is created the shape files will have extensions of **.2 .3** etc. assigned in the order in which they were created.

Example:	original program	PROGRAM.G
	file created by shape editor	PROGRAM.CAM
	file created by shape editor	PROGRAM.GEO
	first shape file created	PROGRAM.1
	second shape file created	PROGRAM.2
	third shape file created	PROGRAM.3 etc.....
	first tool path	PROGRAM.T1
	second tool path	PROGRAM.T2
	third tool path	PROGRAM.T3 etc.....



**To COPY all the program files to the A: (Floppy Disk) when using the CAM continued.....**

The 5000M uses the C:/USER drive in the Program Directory. Upon entering the Program Directory the programs displayed will all have an extension of .G

To view all the program files described on the previous page the operator must first LOG to the the root of C:\USER directory (this is where all program files with any extension can be viewed). This is achieved by using wildcard symbols. These symbols are \* . \* (any program name with any extension).

(1) From the PROGRAM directory Press  (Shift) this will change the descriptions of the F keys,

Press  This shows a menu of the drives that the operator can view on screen.

(2) High light Other:  and Press 

(3) At the next menu  type \*.\* Press     

(4) Press  The screen will now display all programs with all extensions.

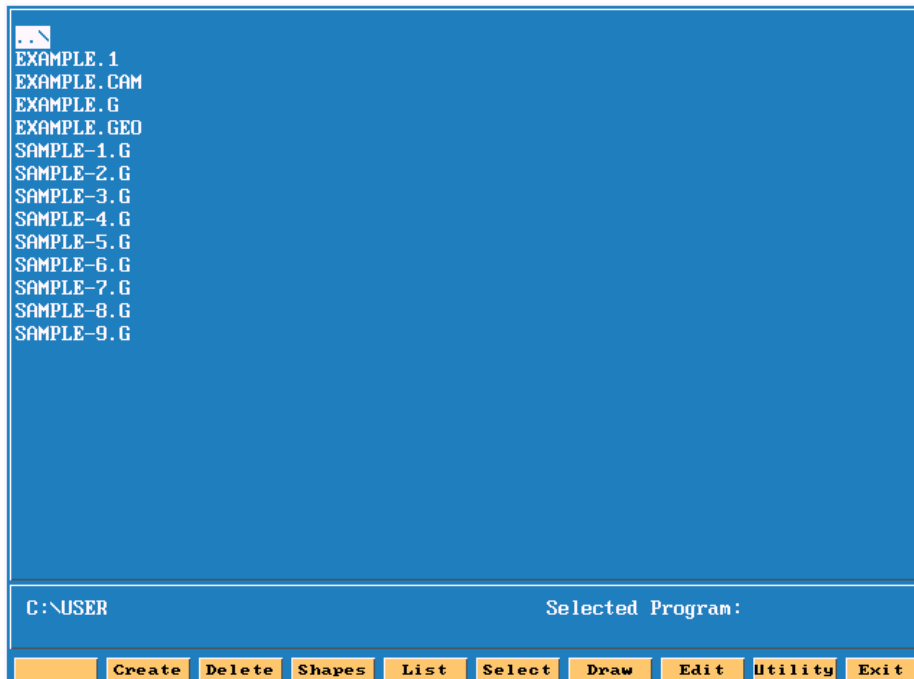

**To COPY all the program files to the A: (Floppy Disk) when using the CAM continued.....**

An alternative method is also provided to obtain the screen showing all programs with all extensions Directory.



**Display**

This method is completed using the  and **Display** keys.

This sequence of key strikes toggles the Program Directory display through the following screens. The key strikes are repeated to toggle through the screens shown below.

```
EXAMPLE.G
SAMPLE-1.G
SAMPLE-2.G
SAMPLE-3.G
SAMPLE-4.G
SAMPLE-5.G
SAMPLE-6.G
SAMPLE-7.G
SAMPLE-8.G
SAMPLE-9.G
```

Screen on entry into Program Directory (displays .G programs only)

```
EXAMPLE.G          716  10/12/1999  03:36 pm
SAMPLE-1.G        1,114  02/16/1999  11:42 am
SAMPLE-2.G        1,184  02/16/1999  11:45 am
SAMPLE-3.G        1,053  02/16/1999  11:45 am
SAMPLE-4.G        1,686  02/16/1999  11:46 am
SAMPLE-5.G        1,725  02/16/1999  11:46 am
SAMPLE-6.G        2,339  02/16/1999  11:46 am
SAMPLE-7.G        1,566  02/16/1999  11:46 am
SAMPLE-8.G        2,817  02/16/1999  11:47 am
SAMPLE-9.G        3,557  02/16/1999  11:47 am
```

Screen after 1st sequence (displays .G programs and size date and time created)

```
EXAMPLE.1
EXAMPLE.CAM
EXAMPLE.G
EXAMPLE.GEO
SAMPLE-1.G
SAMPLE-2.G
SAMPLE-3.G
SAMPLE-4.G
SAMPLE-5.G
SAMPLE-6.G
SAMPLE-7.G
SAMPLE-8.G
SAMPLE-9.G
```

Screen after 2nd sequence (displays all programs \*.\*)

```
<DIR> 04/19/1999  03:18 pm
EXAMPLE.1          594  11/19/1999  02:05 pm
EXAMPLE.CAM       6,028  11/19/1999  02:05 pm
EXAMPLE.G          716  10/12/1999  03:36 pm
EXAMPLE.GEO       3,302  10/14/1999  04:41 pm
SAMPLE-1.G        1,114  02/16/1999  11:42 am
SAMPLE-2.G        1,184  02/16/1999  11:45 am
SAMPLE-3.G        1,053  02/16/1999  11:45 am
SAMPLE-4.G        1,686  02/16/1999  11:46 am
SAMPLE-5.G        1,725  02/16/1999  11:46 am
SAMPLE-6.G        2,339  02/16/1999  11:46 am
SAMPLE-7.G        1,566  02/16/1999  11:46 am
SAMPLE-8.G        2,817  02/16/1999  11:47 am
SAMPLE-9.G        3,557  02/16/1999  11:47 am
```

Screen after 3rd sequence (displays all programs \*.\* and size, date and time created)

```
EXAMPLE.G
SAMPLE-1.G
SAMPLE-2.G
SAMPLE-3.G
SAMPLE-4.G
SAMPLE-5.G
SAMPLE-6.G
SAMPLE-7.G
SAMPLE-8.G
SAMPLE-9.G
```

C:\USER Selected Program:

Create Delete Shapes List Select Draw Edit Utility Exit

Screen after 4th sequence returns to the Program Directory (displays .G programs only)

**To COPY all the program files to the A: (Floppy Disk) when using the CAM continued.....**

To COPY all the EXAMPLE program files shown below complete the following:

(1) Use the  keys to High light the first program to be copied (EXAMPLE.1) to the Floppy Drive

(2) Using the  key High light the remaining EXAMPLE program files



(3) Press  and with Copy Hi-lited  Press 

a menu is displayed  with A: Hi-lited Press  The lower left corner of the

screen displays  Press 

COPYING.... will be displayed while the programs are copied. The procedure is complete when COPYING.... is no longer displayed.

**To COPY program files (all extensions) from the A: (Floppy Disk) to the C:\USER directory.**

- (1) From the Program Directory (C:\USER) use either method described previously to display the programs with all the extensions.
- (2) Insert the Floppy Disk into the Drive
- (3) LOG to the A: Drive
- (4) High light the program files to Copy to C:\USER Press ENTER
- (5) LOG back to the C: Drive

# ANILAM

## 5000M CNC CONTROL Simple Program



## CREATING A PROGRAM

From Manual page press



The softkeys will be changed as shown below.

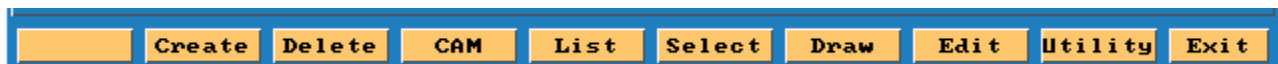

Press



Type the program name (Maximum 8 letters/numbers).

Press Enter to go into program directory



LAWRENCE.G	NICE2.G	SHUTTLE.G	TNC.G
LETR230.G	07_SAMPL.G	SLOTMAC.G	WINDOW-M.G
LETRCAL1.G	PAGODA2.G	SNOWMAN.1	WOMAN.G
LETSAMBL.G	PHIL.G	SNOWMAN.CAM	WY.G
LTRS230.G	POCK.G	SNOWMAN.G	
MAINTTEST.G	POCK.M	SNOWMAN.GEO	
MATT1000.G	POCKETS.G	SNOWMAN.T1	
MER-FIN.G	POCKETS.M	SNOWMAN.T2	
MER-ROU.G	POCKETS1.G	SPIRAL.G	
MERC-ARC.G	POCKETS1.M	SPIRAL.S	
MERC-LIN.G	<u>PROGRAM.G</u>	STOCKVAR.G	
MERC-LIN.M	REPEAT.M	T.G	
MERC1.G	RICH.G	T.NC	
MERC2.G	RON.G	TAPE.G	
MERC3.EXE	ROUGH.G	TAPE.S	
MERC3.G	ROUGH1.G	TAPE3200.G	
MILL.G	ROUGH22.G	TAPE3200.M	
MILL.M	SAM.G	TAPE3200.NCC	
MILL1.G	SAM1.G	TAPPING.G	
MODERN.G	SAM2.G	TC.G	
MONARCH.G	SCHWADA1.G	TEST.G	
NATHAN.G	SCHWEDA.G	TEST2.G	
NATHAN.M	SCHWEDA4.G	THREAD.G	
NICE.G	SHOW98HA.G	TIM.G	

C:\USER SELECTED PROGRAM:

Create	Delete	CAM	List	Select	Draw	Edit	Utility	Exit
--------	--------	-----	------	--------	------	------	---------	------

High light will be on program just created.

Press



This is how screen will appear when entering **EDIT**

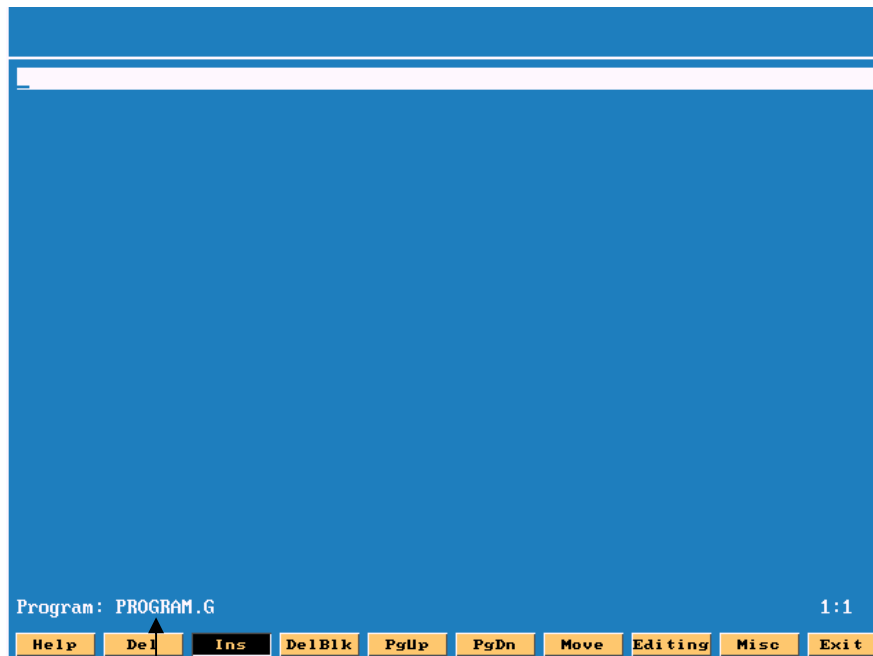

Program name



**Note:** Insert is turn ON ,if not will not go past bottom of page.

**Note:** Softkeys have change .

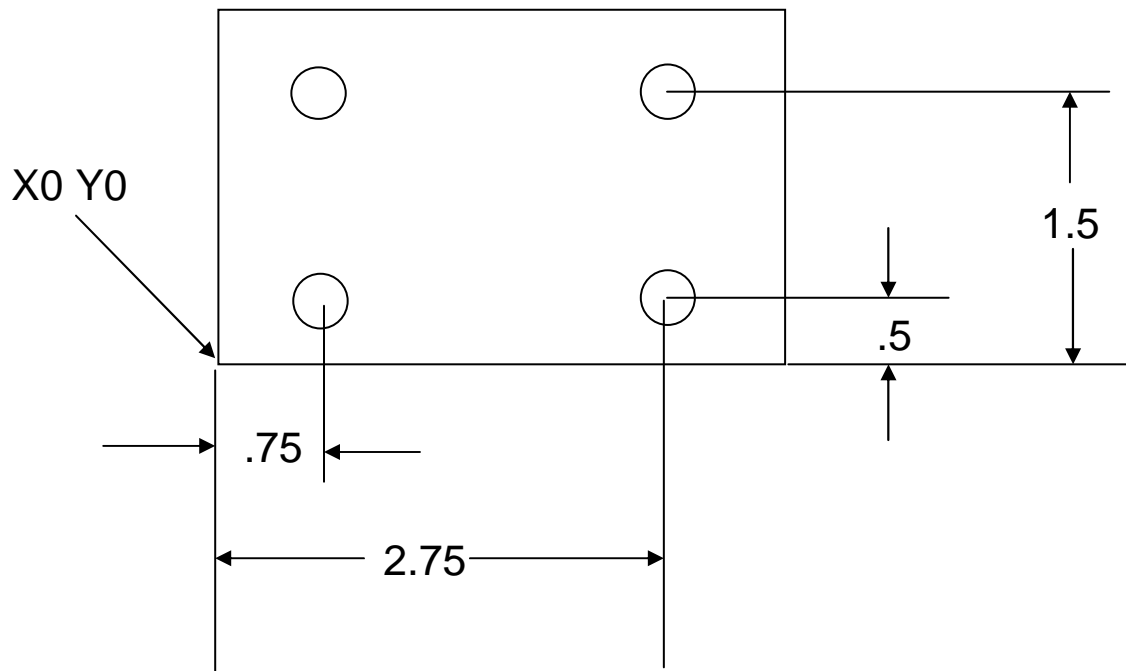

This part needs to have 4 hole drilled .25 dia and .5 deep



Press



High light will be on **G0** press enter



Move high light **G17** , **G70** and **G90** press enter on each of these.

Press **M5** press



Press



it will go into program as shown below.



Top line of program.

```
G00 G17 G70 G90 M5      *RAPID,XY PLANE,INCH,ABSOLUTE,POSITION,SPINDLE OFF
G00 G17 G70 G90 M5      *RAPID,XY PLANE,INCH,ABSOLUTE,POSITION,SPINDLE OFF
T1 M6                   *LOAD TOOL,M6 ONLY REQUIRED IF TOOL CHANGER INSTALLED
S2000 M3                 *SET SPINDLE SPEEDAND TURN ON SPINDLE

```

Program: PROGRAM.G (edited) 4:1

Help Del Ins DelBlk PgUp PgDn Move Editing Misc Exit

Program has been edited

Cursor position line and column

Lines 2 and 3 are typed in manually.

The \* allows commence into program control will read ignore after it.

Press

**F1**

**HELP**

press #9 for **DRILL** press



Screen will appear as shown below.

<b>COUNTERBORE</b>  G82 3	<b>PECKING</b>  G83 4	<b>TAPPING</b>  G84 5	<b>BORE/BI</b>  G85 6	<b>BORE/UNI</b>  G86 7	<b>CHIP BREAK</b>  G87 8
<b>DRILLING</b>  G81 2	[Large blue area containing G-code and settings]				<b>FLAT BORE</b>  G89 9
Incr. G91 Absolute G90					<b>BOLT CIRCLE</b>  G79 $\frac{+}{-}$
MM G71 Inch G70					<b>PATTERN</b>  G179 .
YZ Plane G19 XZ Plane G18 XY Plane G17					*RAPID,XY PLANE, INCH, ABSOLU *LOAD TOOL, M6 ONLY REQUIRED *SET SPINDLE SPEED AND TURN
<b>CANCEL G80</b> 1					

↑ ↓ Text Select Abort Accept Prev Exit

Press #2 for basic drilling, press enter.



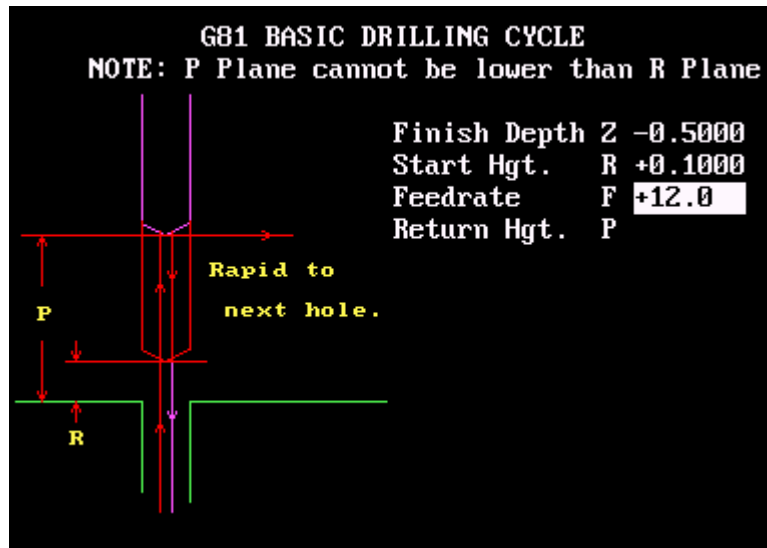

Enter values Finish Depth -.5 press down arrow, enter Start Hgt. .1 down arrow and Feedrate 12

Press **F10** **Exit** exits help menu and enters line into program.

```
G00 G17 G70 G90 M5      *RAPID,XY PLANE, INCH,ABSOLUTE,POSITION,SPINDLE OFF
G00 G17 G70 G90 M5      *RAPID,XY PLANE, INCH,ABSOLUTE,POSITION,SPINDLE OFF
T1 M6                    *LOAD TOOL,M6 ONLY REQUIRED IF TOOL CHANGER INSTALLED
S2000 M3                 *SET SPINDLE SPEEDAND TURN ON SPINDLE
G81 Z-0.5000 R0.1000 F12.0 *BASIC DRILLING CYCLE
```

The next enter hole positions.

Type **G0 X.75 Y.5**  **X2.75**  **Y1.5**  **X.75** 

Type **G80** 

Cancel drill, this must always in program after last hole.

```
G00 G17 G70 G90 M5      *RAPID,XY PLANE,INCH,ABSOLUTE,POSITION,SPINDLE OFF
G00 G17 G70 G90 M5      *RAPID,XY PLANE,INCH,ABSOLUTE,POSITION,SPINDLE OFF
T1 M6                   *LOAD TOOL,M6 ONLY REQUIRED IF TOOL CHANGER INSTALLED
S2000 M3                *SET SPINDLE SPEEDAND TURN ON SPINDLE
G81 Z-0.5000 R0.1000 F12.0
X.75 Y.5                *FIRST HOLE LOCATION
X2.5                    *NEXT LOCATION
Y2                      *NEXT LOCATION
X.75                    *NEXT LOCATION
G80                     *CANCEL DRILL
Z5                      *RAISE Z AXIS TO ACLEARANCE POSITION
X-2 Y4                  *MOVE X AND Y TO ALLOW ACCESS TO PART
M2                      *END OF PROGRAM_
```

Type in last three lines.



Soft key will change as shown below.

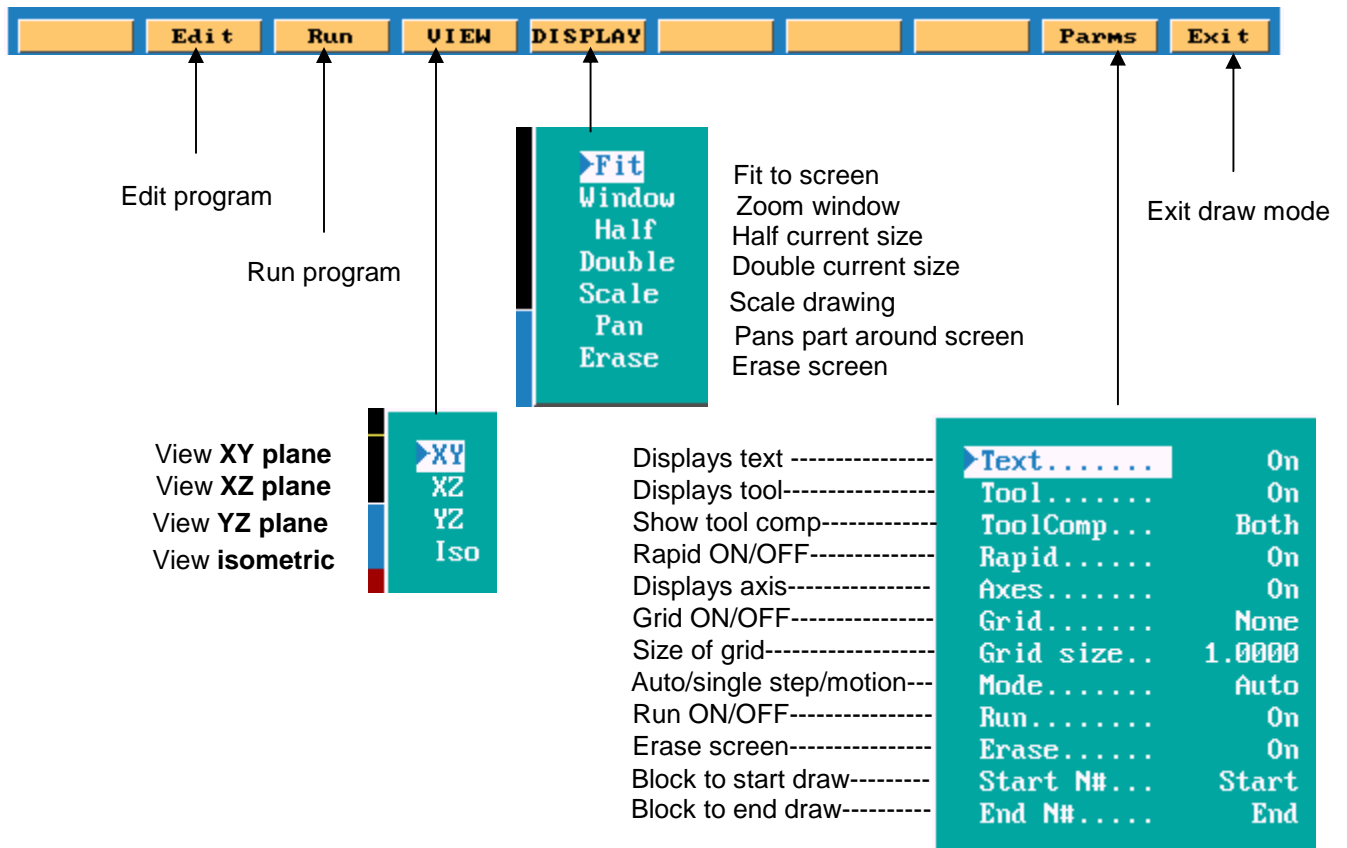

Press **F5** **DISPLAY** cursor will be on **FIT** press enter



This will fit drawing to screen.

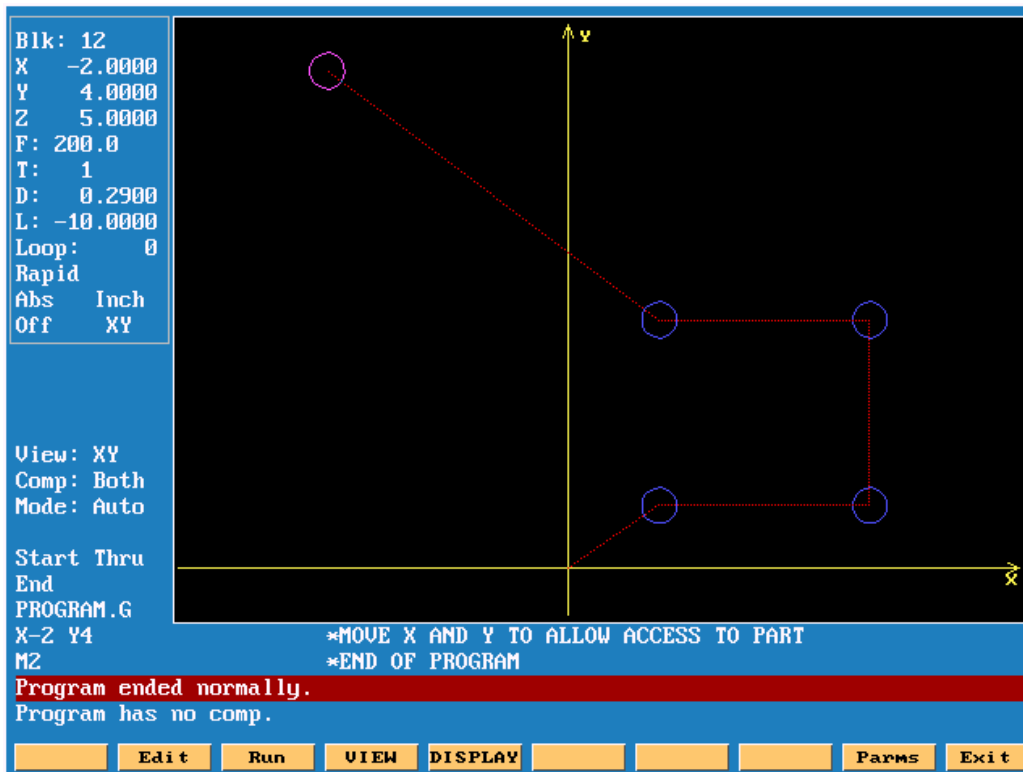

Red lines are **RAPID** moves , blue circle are the holes and purple circle is the tool.

Press **F10** **Exit** this brings control back to program page

Press **F6** **Select** to select program ,check that high light is on correct program.

Press **F10** **Exit** go to **Manual**

## SETTING PART ZERO.

If using an edge finder , touch edge of part using jog keys.

Go to tool page press **F9** **Tool** press **F1** **OFFSETS**

G53 Offset					
	X	Y	Z	U	W
1.	-10.0000	-10.0000	0.0000	0.0000	0.0000
2.	-20.0000	-10.0000	0.0000	0.0000	0.0000
3.	0.0000	0.0000	0.0000	0.0000	0.0000
4.	0.0000	0.0000	0.0000	0.0000	0.0000
5.	0.0000	0.0000	0.0000	0.0000	0.0000
6.	0.0000	0.0000	0.0000	0.0000	0.0000
7.	0.0000	0.0000	0.0000	0.0000	0.0000
8.	0.0000	0.0000	0.0000	0.0000	0.0000
9.	0.0000	0.0000	0.0000	0.0000	0.0000
10.	0.0000	0.0000	0.0000	0.0000	0.0000
11.	0.0000	0.0000	0.0000	0.0000	0.0000
12.	0.0000	0.0000	0.0000	0.0000	0.0000
13.	0.0000	0.0000	0.0000	0.0000	0.0000

CalibX CalibY CalibZ CalibU CalibW Exit

Cursor to required **OFFSET** using arrow up and down keys.  
Move X axis until part is located with edge finder.

Press **F4** **CalibX** is will enter value into table.

Because the edge find is .2 dia the position will be incorrect , press the letter **A** key ,a box as shown below will appear.  
Type in **X.1** this will adjust offset to correct position press **ENTER**.

▶Enter axis and adjustment value: X.1\_

Repeat for **Y** axis

All offset are taken from machine Home position.

## SETTING TOOL LENGTH OFFSETS

Put tool in spindle , bring tool tool down to top of part.

Press **F9** **Tool** high light correct tool number in tool page

press **F8** **CalibZ**

If there are more move Z axis up change to next tool and calibrate it as before,tool #0 must always be active when setting offsets.

Press **F10** **Exit** when all tools are calibrated.

## RUNNING PART.

Press **F6** **Auto** turn down feedrate override knob to 10%

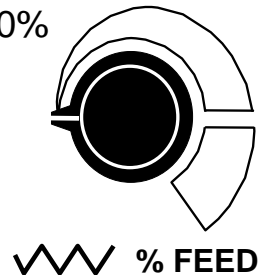

Press 

If machine has a tool changer ,it will put tool #1in spindle if not already there.

If no tool changer install it will stop and allow you to change tool if necessary .

When program complete **Z** axis will go up to 5" above part.



# ANILAM

## 5000M CNC CONTROL GENERATING PROGRAMS USING CAM



**STEP BY STEP CREATION OF A PROGRAM USING THE SHAPE EDITOR**

The following presentation shows a step by step procedure of how to create a part program using the Anilam 5000 Control.

This procedure details the use of the interactive CAM that creates the part profile through simple entry of geometrical elements (points, lines and circles) without having to calculate intersections, tangency points etc. These elements are then connected or “chained” to complete the shape.

**Creating the Part Program File in the PROGRAM page.**

(1) From the MANUAL mode press: **Program**

**NOTE:** There are 2 methods of creating a program file, both are shown below.

**Method No.1** Creating a new program file.

(2) Press: **Create** At the prompt **NEW PROGRAM: \_** type in the program name



**NOTE:** Program names can be up to 8 characters in length, but may not include spaces or periods.

**Method No.2** Copying and using an existing program.

If a similar program to that required already exists, it may be copied and given a new name. This allows similarly formatted programs to be used without having to re-type the information.

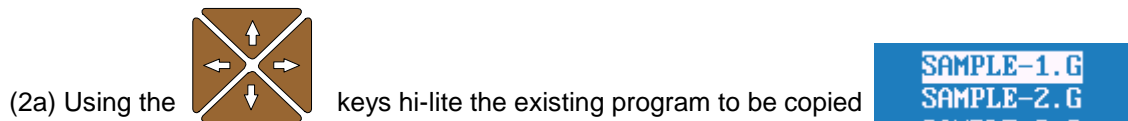

(2a) Using the keys hi-lite the existing program to be copied



Press: **Utility** this brings up a menu, with Copy hi-lited



press This will display a second menu Hi-lite Other and press



This will bring up a third menu type in the new program name

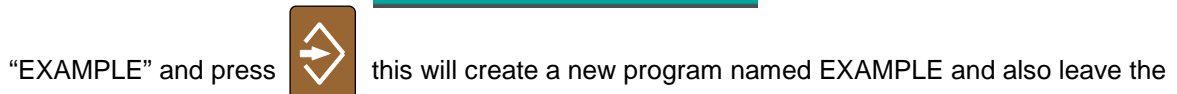

“EXAMPLE” and press this will create a new program named EXAMPLE and also leave the

original program “SAMPLE1.G” intact. This copied program can now be edited to suit the new part. It is not necessary to type the file extension (.G) as this is completed automatically.

- High light the name the needs the program for, press **CAM**
- The machine program can be coompletely produced in CAM.

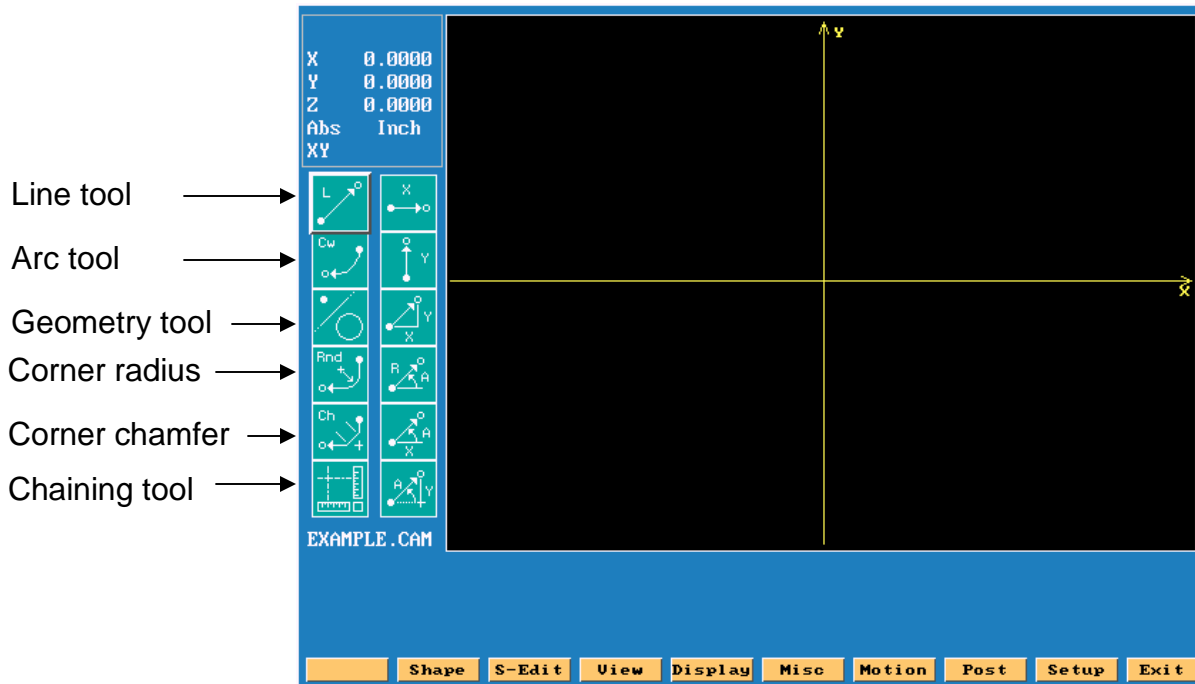

When **Shape** is press, soft keys will change as shown below.

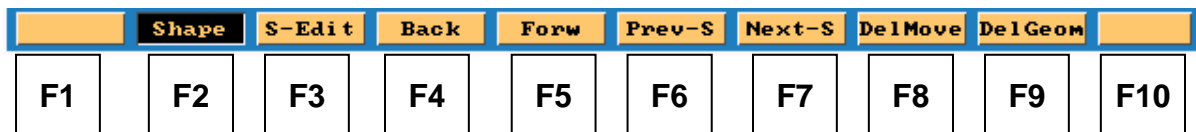

- F4- Back** Moves curser backwards on a shape.
- F5- Forw** Moves curser forward on a shape.
- F6- Prev-S** Moves curser to previous shape.
- F7- Next-S** Moves curser to next shape.
- F8- DelMove** Deletes last move in shape.
- F9- DelGeom** Deletes geometry, an element number is required.

Press **Shape** again to turn OFF and return previous funtion keys

Pressing **S-Edit** the following pop-up menu will appear



- Create** Create a start point for a shape.
- Copy** Copy a shape to another location.
- Move** Move a shape to a new location.
- Delete** Delete a shape.
- Rev Arc** Reverses direction of an arc in a shape.
- Project** Replaces a radius and joins lines.
- Join** Connects lines together.
- Import** Imports shape from another CAM file.

Pressing **View** the following pop-up menu will appear



- XY plane
- XZ plane
- YZ plane
- Isometric

Pressing **Display** the following pop-up menu will appear

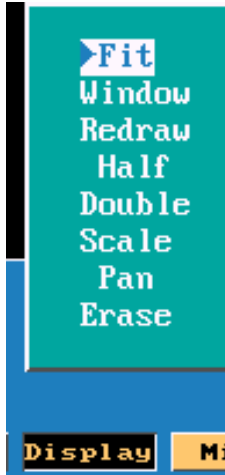

- Fit to screen.
- Zoom in on windowed area.
- Redraw screen
- Half size of screen.
- Double size of screen.
- Scale screen.
- Pan move part around on screen.
- Erase screen.

Pressing **Misc** the following pop-up menu will appear

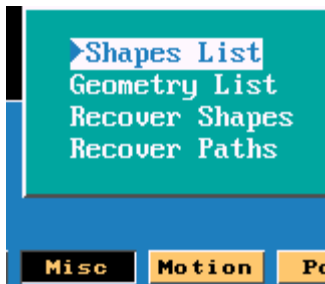

- List shapes by number.
- Lists all geometry. Showing coordinates.
- Recover a deleted shape.
- Recover a deleted tool path.

Pressing **Motion** the following pop-up menu will appear

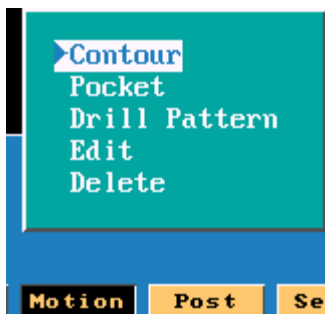

- Generate a tool path around a shape.
- Generate tool path for pocketing a part.
- Drilling cycles and paths.
- Edit any of the above paths.
- Delete a tool path.

Pressing **Setup** the following pop-up menu will appear

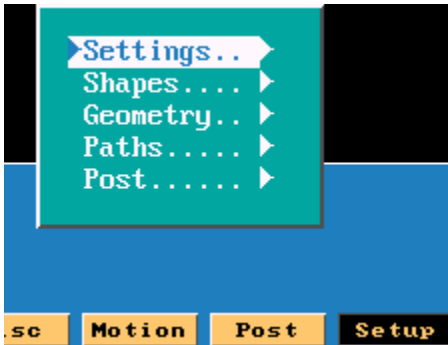

Parameters for CAM.  
 Turn shapes ON/OFF.  
 Turn geometry ON /OFF.  
 Turn tool paths ON/OFF.  
 Parameters for post.

When high light is on setting press



the pop-up menu will appear.

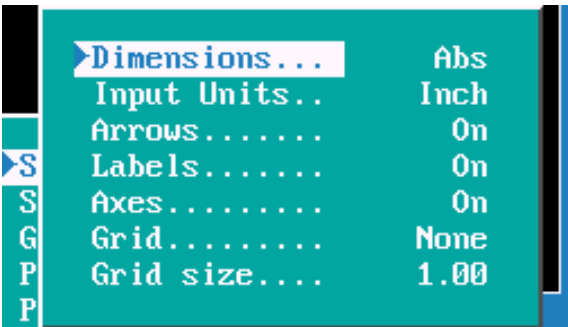

Type of dimensioning ABS/INC.  
 Units INCH/MM.  
 Turns Arrows ON/OFF.  
 Turns ON/OFF element labels.  
 Turns Axis markers ON/OFF.  
 Turns grid ON/OFF.  
 Size of grid.

When high light is on paths press



the pop-up menu will appear.

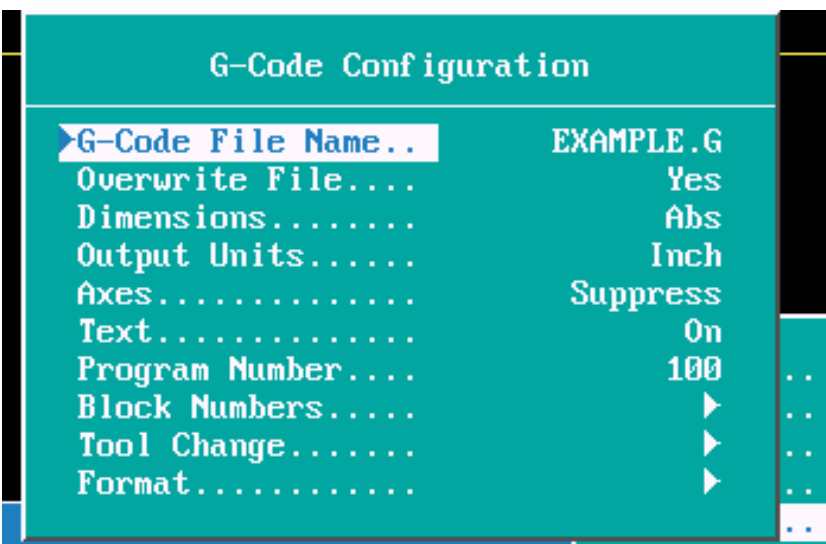

Out-put program name.  
 Over write existing program.  
 Out-put type ABS/INC.  
 Unit INCH/MM.  
 Only out-put Axis if it moves.  
 Text on while posting.  
 Program number.  
 Block number.  
 Tool change requirements.  
 Format Number of decimals

The part below needs to be pocketed.

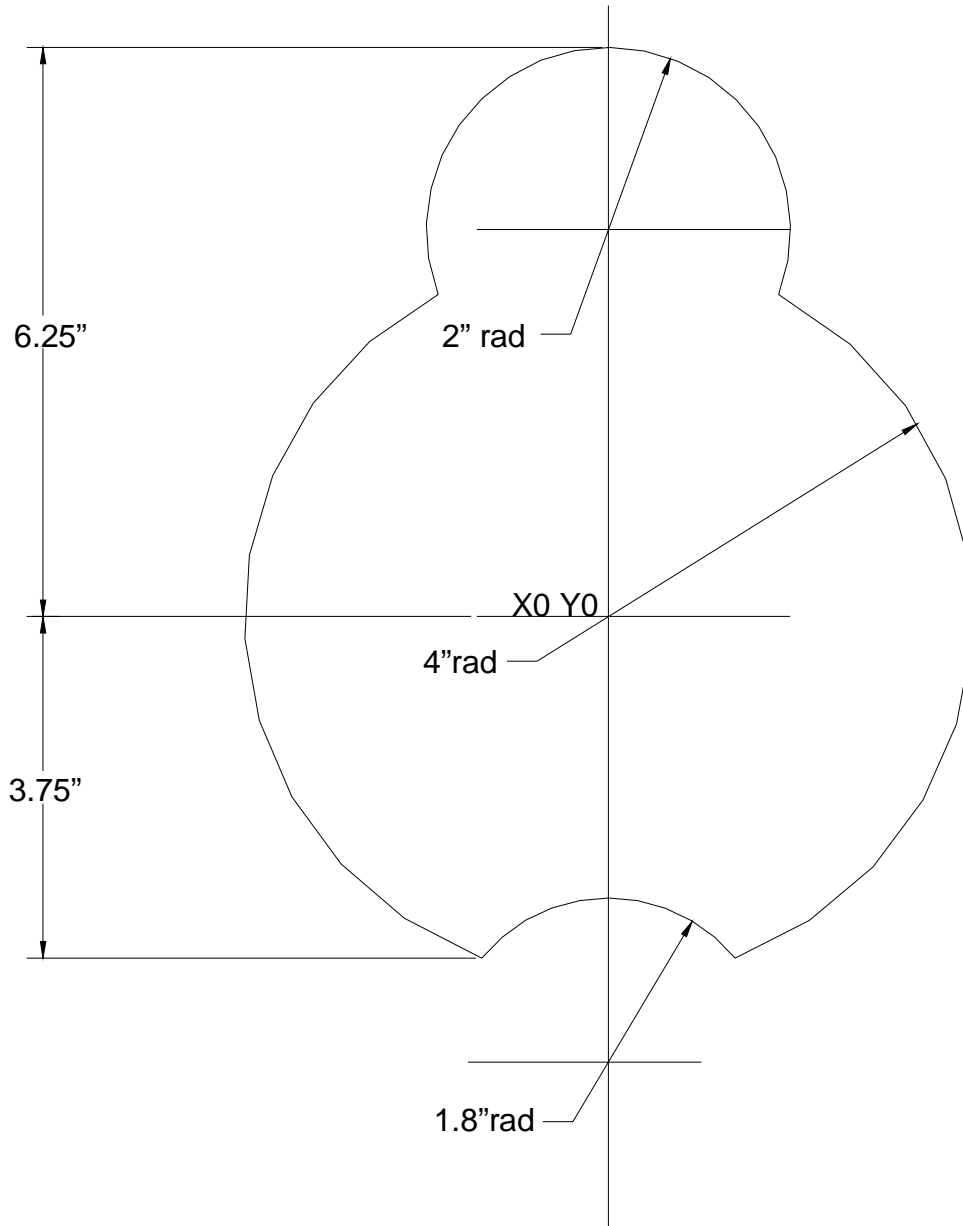

When **CAM** is accessed The high light will be on the top left icon, for the following exercise the third icon down is the one required.





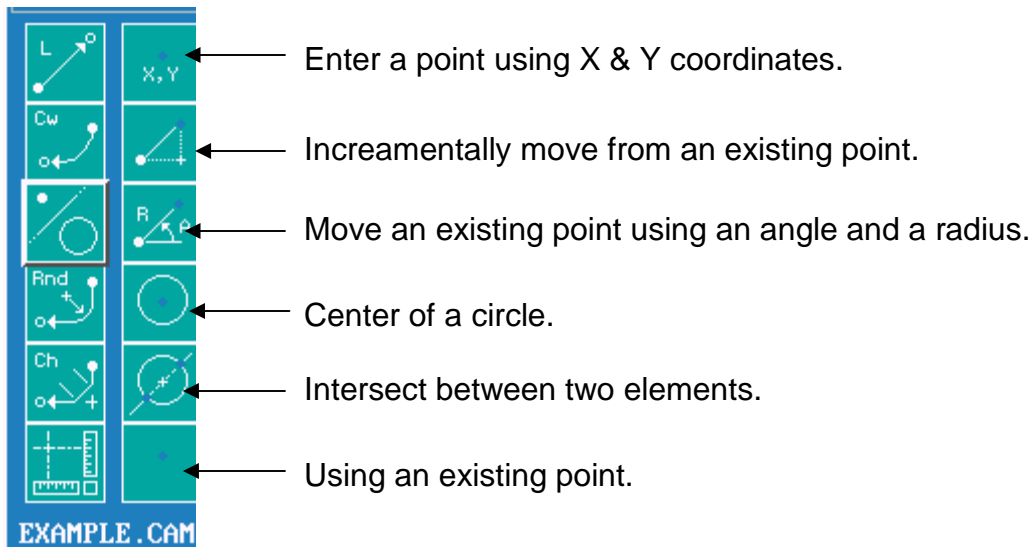









Press  down arrow key twice icon on right will become point definitions.

















Press  icon on right will change to line definitions.

		← A line along X axis.
		← A line along Y axis.
		← A line between two points
		← A line through a point at an angle.
		← A line parallel to an existing line.
		← A line tangent to a circle through a point.

EXAMPLE .CAM

Press  to get to circle icons.

		← Circle between two existing elements.
		← Circle knowing center point and radius.
		← Circle tangent to a line through a point knowing radius.
		← Circle tangent to a line knowing center point.
		← Line between two circles, four options.
		← Line tangent to a circle through a point.

EXAMPLE .CAM

High light third Icon down on left.

Press  right and then up.

Geometry icon turn blue.



Circle icon high lighted

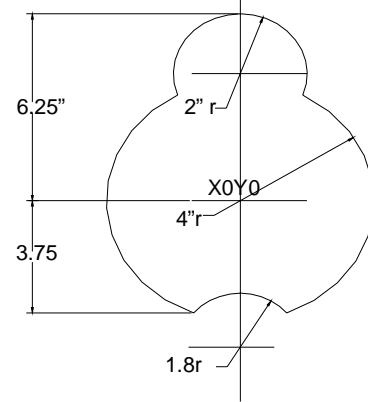



Press  Enter R value: \_ R value =4

Press  EXAMPLE .CAM Select center definition ..



It will now ask for center definition and point definition will appear in right column of icons. The top icon will be high lighted.

Press  it will ask for an value in X0 and Y0  twice.

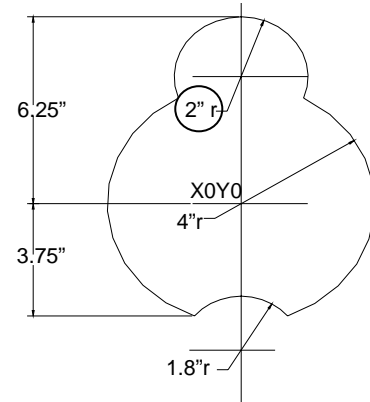
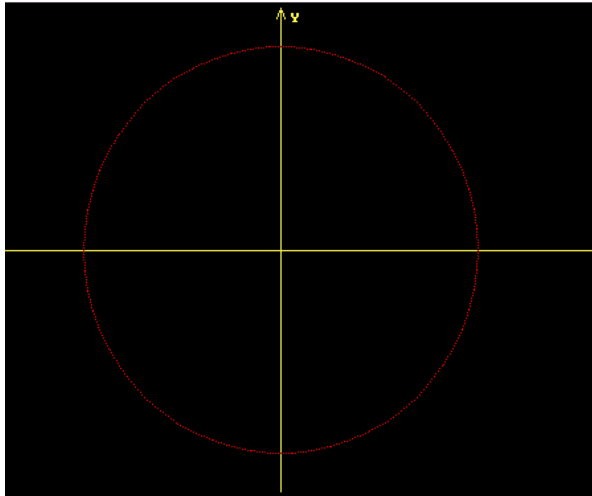

When entry is 0 (zero) ,it is not required to press the 0 key.

Press **F5** **Display** Fit and screen show the circle that was just entered.



Using same icon put in 2" radius circle.

Press  enter 2" for radius

Press  press  to select point value X0 , value Y 4.25 (6.25-2) press 

Two circle will now show up on screen.

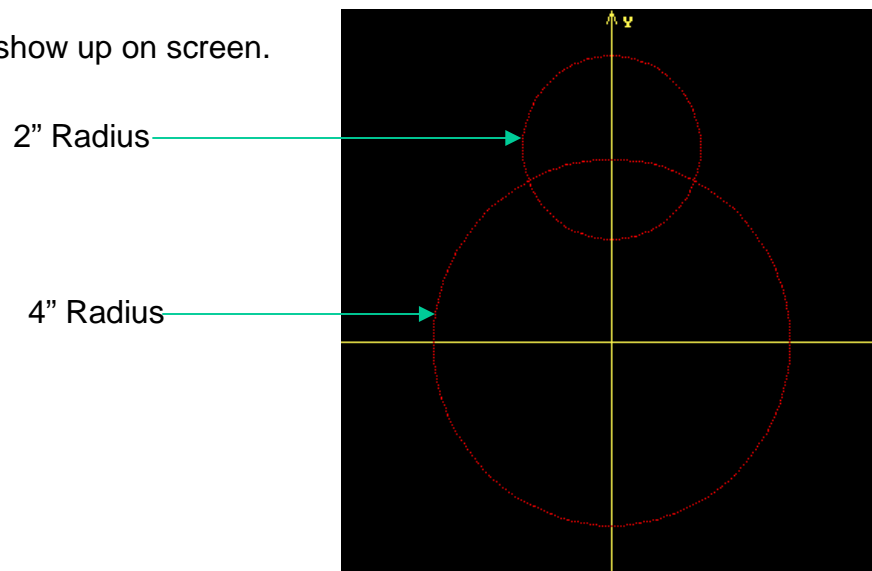

The next element required is the 1.8 radius arc.

In order to do this it is necessary put in some construction geometry.



First a line has to be draw at -3.75 in the Y axis.

First high light geometry icon as shown below,

press  until line definition appear.

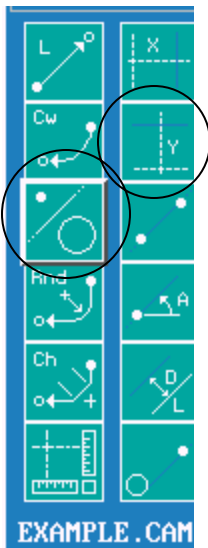
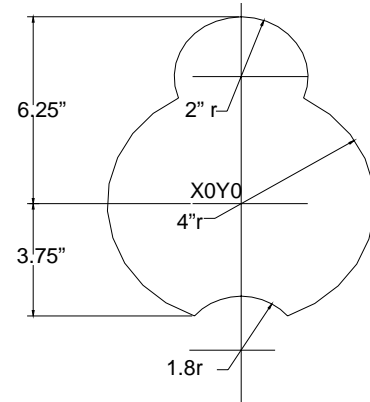
Use arrow keys to get to circled line definition.



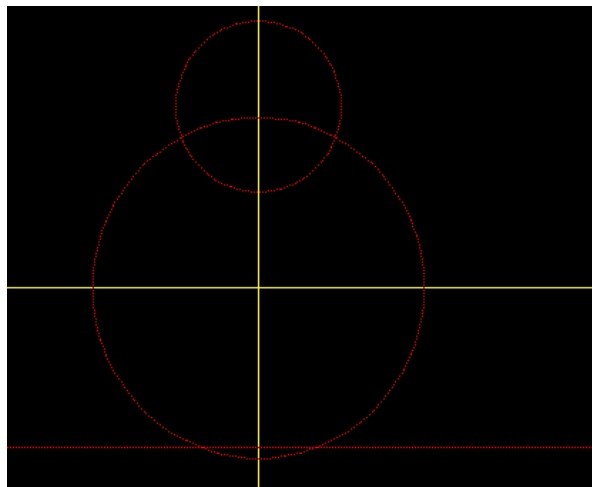

Press  enter a value of -3.75 



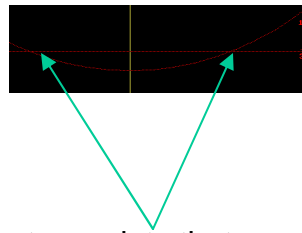
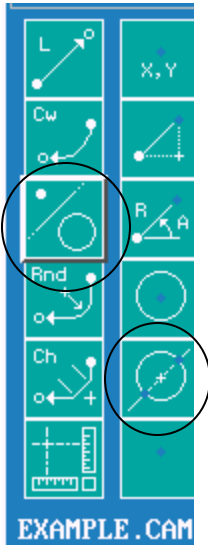

The next geometry required are two points at the intersect of the 4" radius circle and the -3.75 line. To do this use icon circled below.

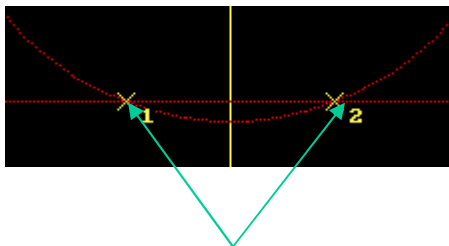

These are the two points that needed to be found. They are the intersect of circle #1 and line #3.

Press  Enter number of first element 1 press  second element 3. 



There are now two selections, press 1 press 

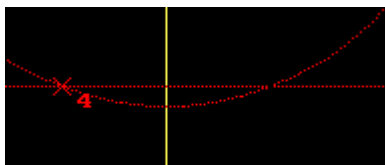

There is now an element #4 on left intersect. Do the same again only select #2.

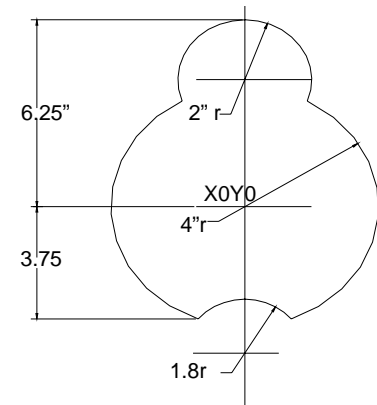

It is now possible to drive an arc between points #4 & #5.

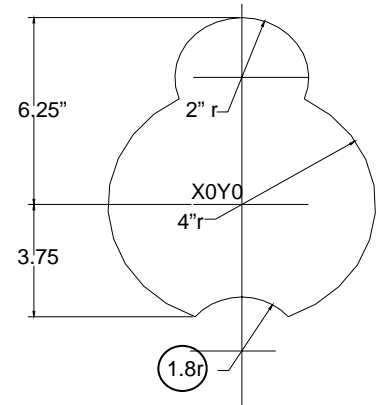
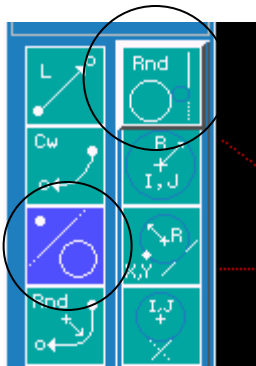
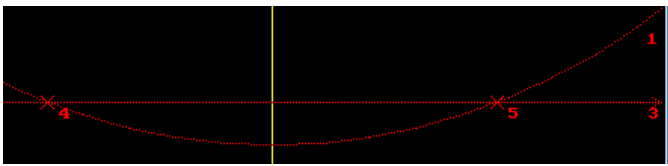

Use the Icon that allows a circle between two elements.

First question R value.  Press 

Second question  Press 

Third question  Press 

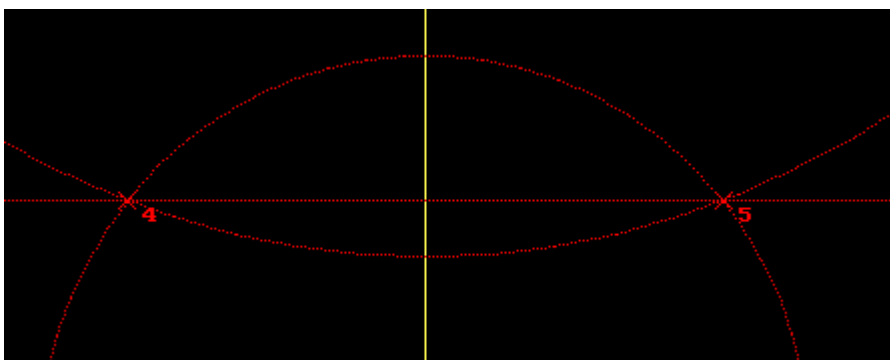

It is necessary to figure the best place to start. On this part the top will allow us to completely clean this shape.

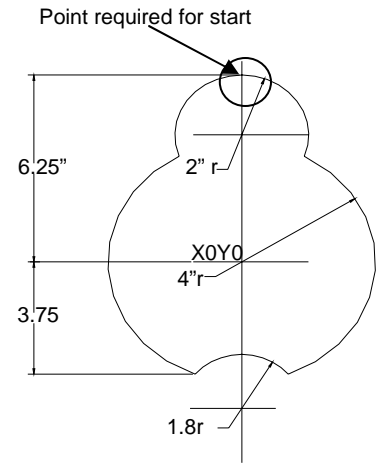
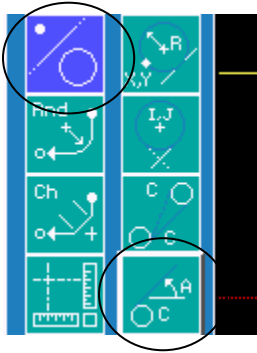

Use icon circled line tangent to a circle at an angle.

First question  Press

Second question  Press

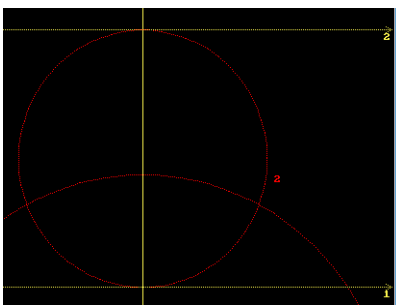

There are two chooses #1 or #2 we will take #2

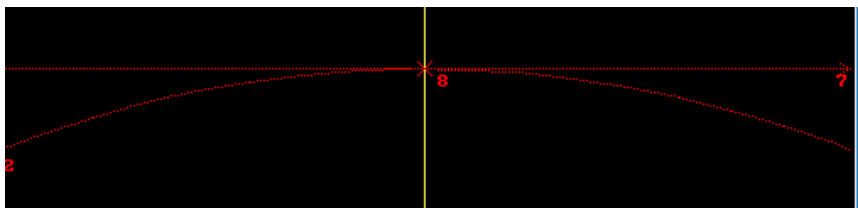

All the necessary geometry has been established, the next thing is to make a shape, to pocket and contour.

Press **F3** **S-Edit**



A start point needs to be established for are shape, high light will be on **Create**. Create will set where the shape is going to start.

Press  select point definition, Use the icon circled.

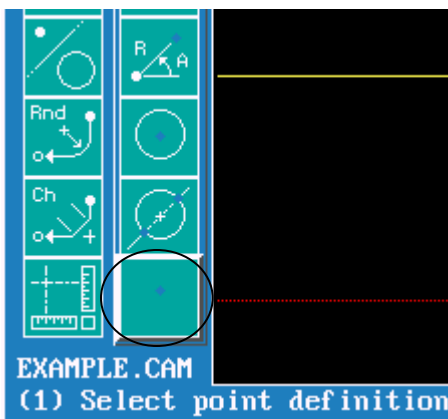



Press  From point: 8\_ Enter 8 when it says "From point"

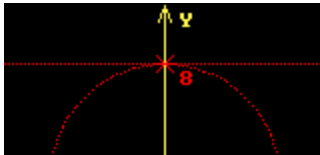

Press 



The white number one is the start point for shape #1.

The icon circle is the construction icon, highlight it press  it will ask for an element to be selected.

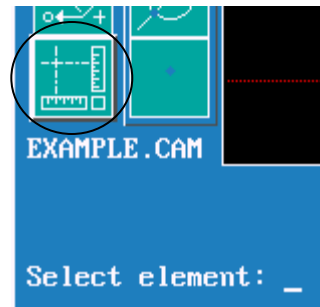

Select element: -2\_ Enter -2 press 

When selecting circles if cutting in clockwise the number is positive if counter clockwise the number is negative as shown above.

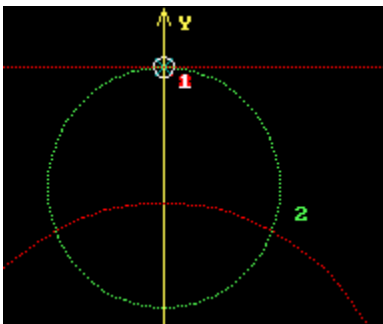

Selected element will show up in green.

The next selection is -1 and there are selection 1 and 2, in this case 2 is required.

Press 2 

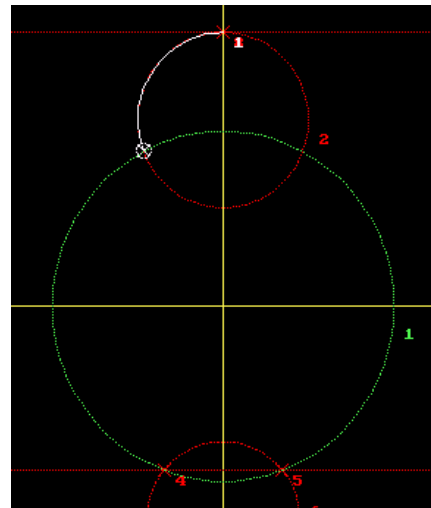
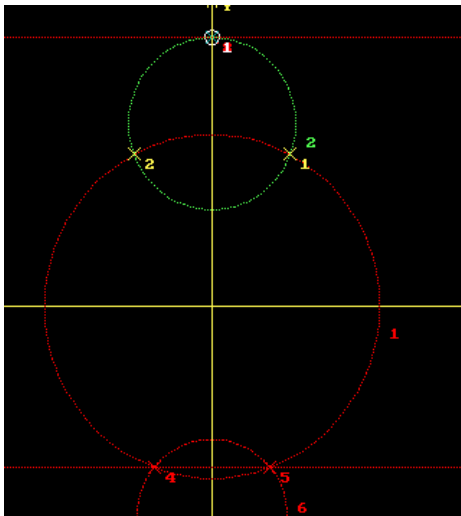

Notice that after 2 was selected element #2 when from green to white and element #1 became green.

The next element is #6, this is positive because the direction is clockwise.

Press 6  select #2 

press -1  select #2 

press-2  select #2 

press 8 

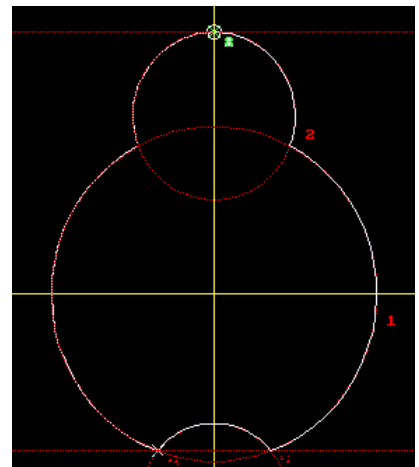

Notice the shape is now outlined in white.

The shape is now complete press F9 Cancel

The geometry and shape are complete, the next is to produce a tool path to pocket and contour.

Press  

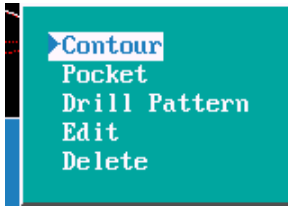

The first tool path is **pocket** using arrow keys high light pocket press.



Press 

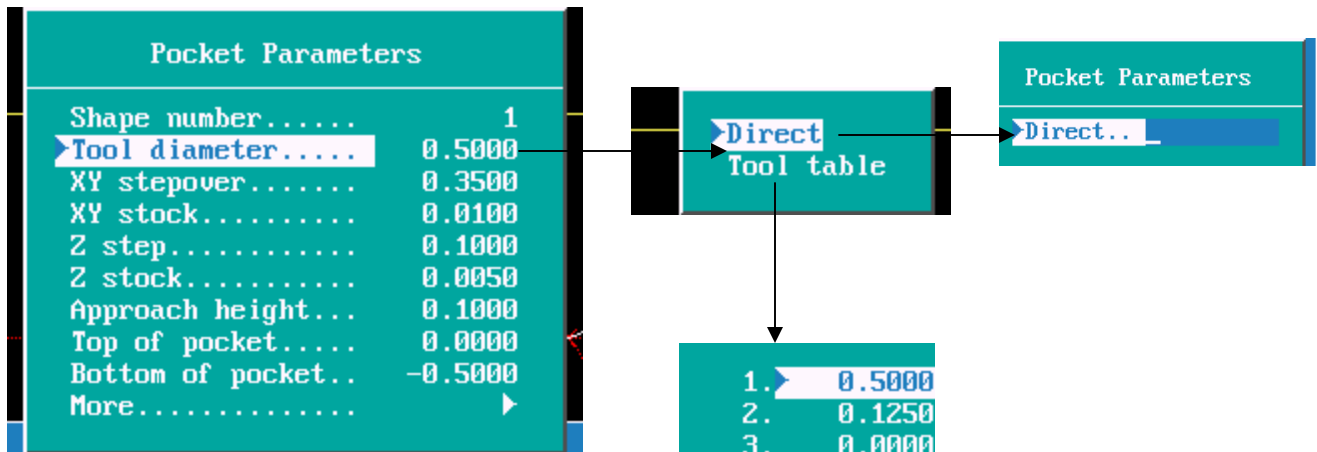

There are two methods of entering tool diameters, direct just type in value and select it from toll table.

1.	0.5000
2.	0.1250
3.	0.0000
4.	0.1250
5.	0.5000
6.	0.1560
7.	0.1870
8.	0.7500
9.	0.5000
10.	0.4500
11.	0.0000
12.	0.0000
13.	0.0000

Tool table

A pop-up window will appear as above.

To enter a value in any of these parameters first press



enter value press



When **More** is reached it will bring up anew pop-up window.

Second page of parameters.

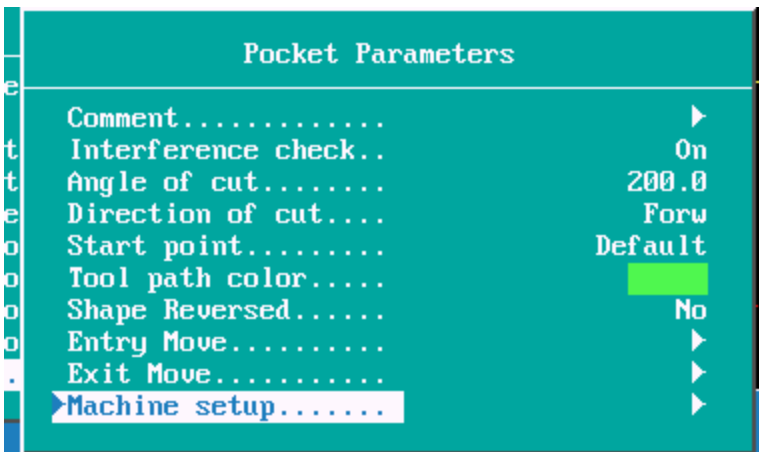

Angle of cut can be left at default or an angle entered, on this part an angle of 200 deg's will be entered.



Entry and Exit Move



these are the three options.

Linear is straight line move on to start point, circular ram on move.

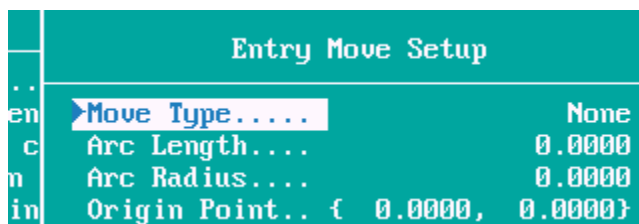

Arc Length is the angle arc ramping on move.  
Arc Radius size ram radius.

When **Machine Set** is high lighted will go to a new pop-up window.

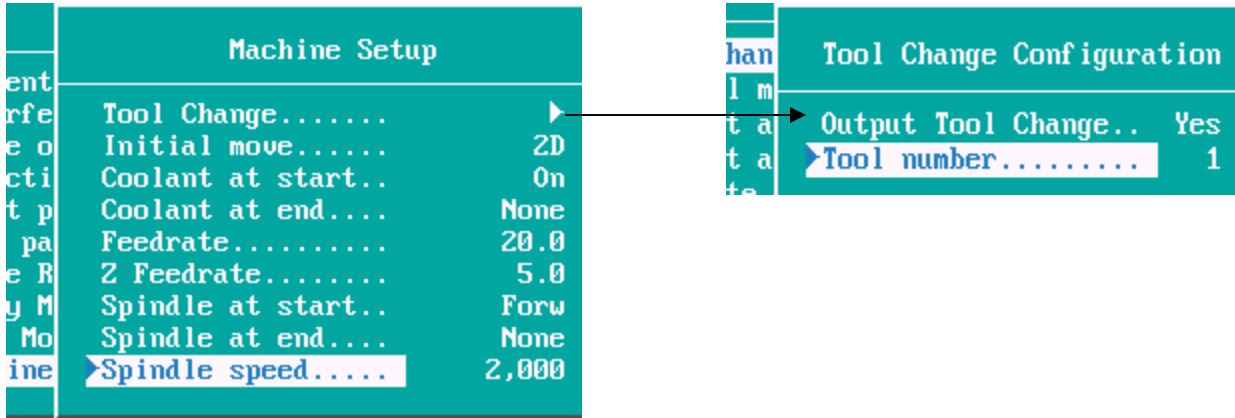

Coolant turn ON at start but not OFF at end as the same tool will be used for pocketing and contouring. The same applies with spindle.

Press **F10** **Cont** Press **F10** **Cont** Press **F8** **Calc**

On the right is how it will appear on screen.  
**Red** is geometry.  
**White** is the shape outline.  
**Green** is tool path.



**F1** **Yes**

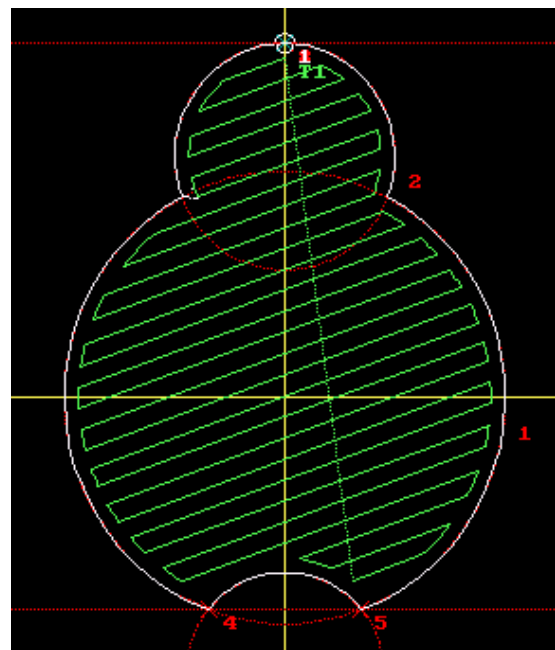

The Contour now need to be done as the edges are still rough.

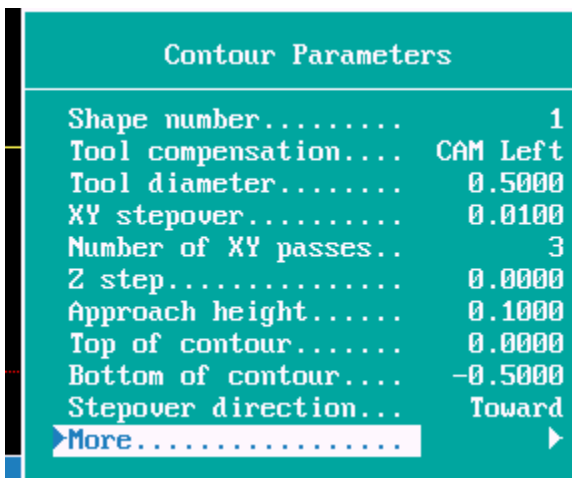
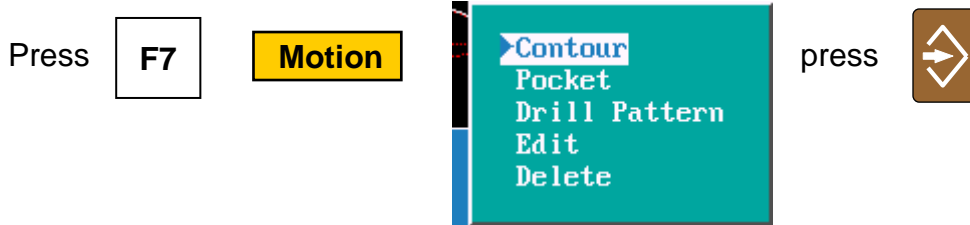

It now needs to know which side to put tool comp.  
 Stepover this is around contour only.  
 Number of passes around contour.

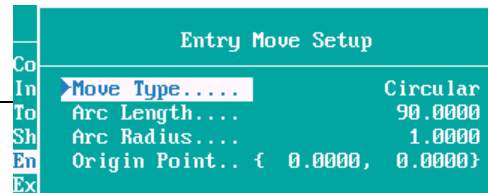
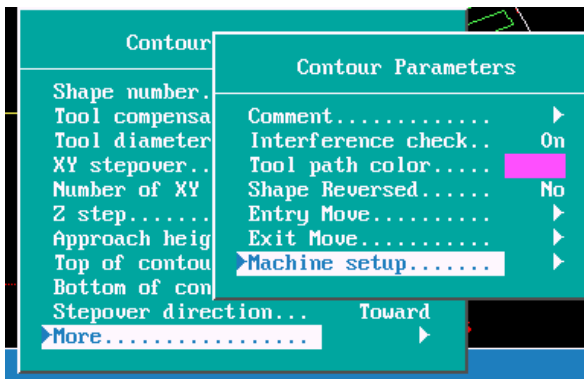

Do this for both Entry and exit moves.

There is no need for a tool change because the same tool is being used for the contour as pocketing.

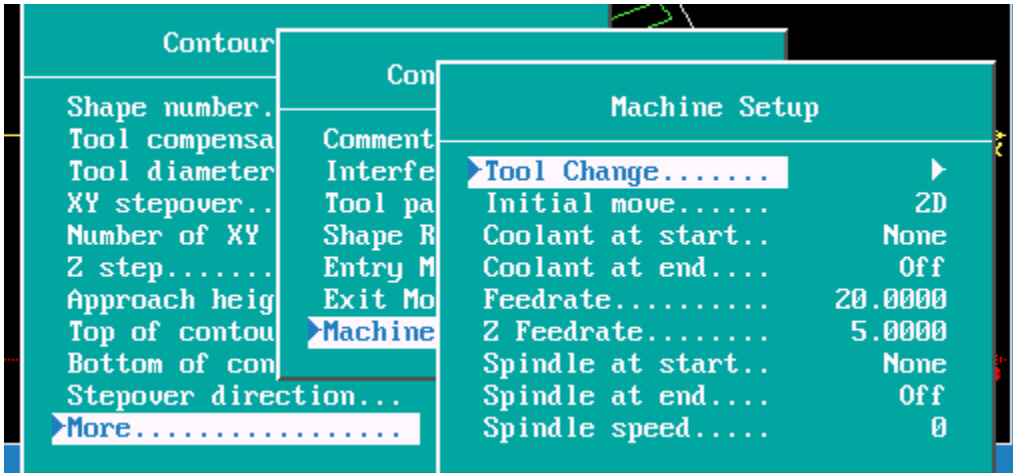

Note: Coolant and spindle at start are entered as **None** and turned **Off** at end, as they are still on from pocketing.

Pocket tool path #1  
 Profile tool path #2

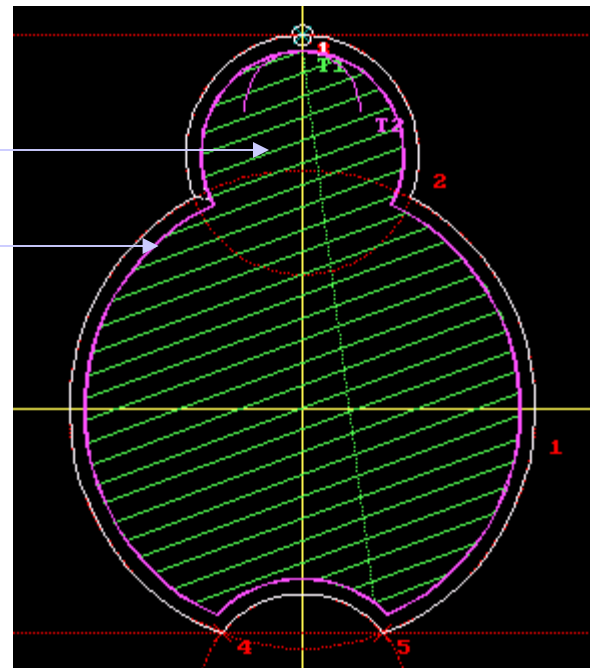



**F9**

**Setup**

Arrow down to post

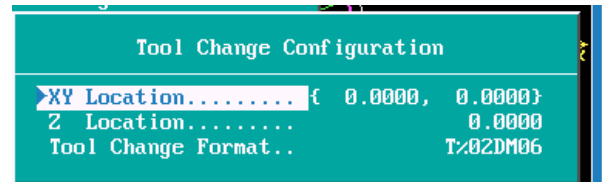
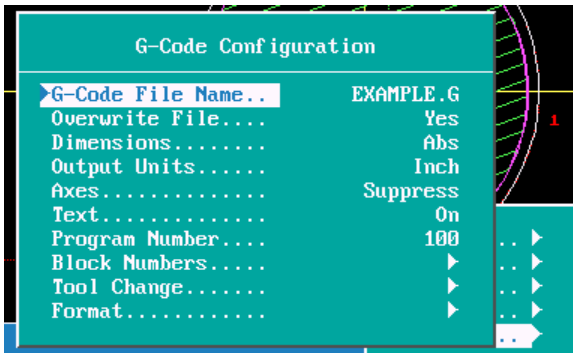
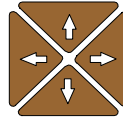

If machine has a tool changer arrow down to Tool Change press enter arrow down to Tool Change Format if M06 is required it should read as follows **T%02DM06**.

Block Number are set to start at 10 and increment by 10 this can be change depending on your preference.

Format is set for 8 decimal place change these to 4.

Press **F10** **Cont** press **F9** **Setup**

Press **F8** **Post**

When finish press **F10** **Exit** it will now return to Program Page.

High light EXAMPLE.G press F7 Draw  
press F5 Display fit will be high lighted press ➔

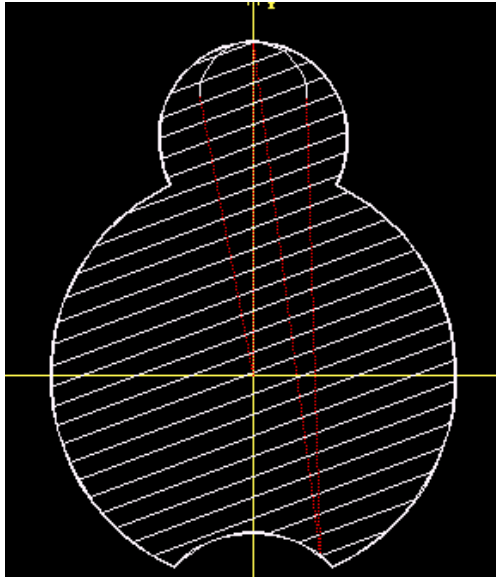



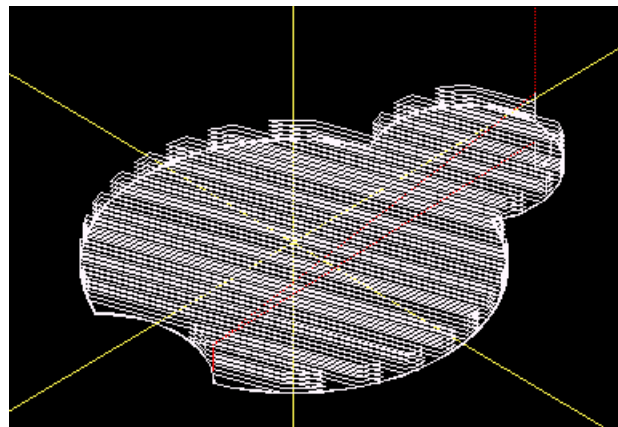



XY view



Isometric view

All that is left to do is set tool length offsets and fixture offsets, part is ready to run.

If the G-Code Configuration is now correct it can be save for future use.

Press    until top left corner shows  
..\ high light EXAMPLE.CAM press   high light  
will be on **Copy** press  Arrow down to **Other** Type in  
**C:\P5M\DEFAULTS.CAM**

# ANILAM

## 5000M CNC CONTROL DXF Converter



DXF file can be converted into 5000 machine programs using the Offline software.

The DXF files are stored in the Program Page.

When going to Program Page only .G and/or .M file will be

displayed,press shift **F8** **Display** twice, this will display all files on **Program** page.

If DXF is on disk it needs to be copied into **C:\User** directory.

press shift **F7** **Log** select **A:**

High light required DXF program press **F9** **Utility** Copy to **C:**

Log back to **C:\User**.

High light DXF program 

Press **F9** **Utility** high light DXF Converter

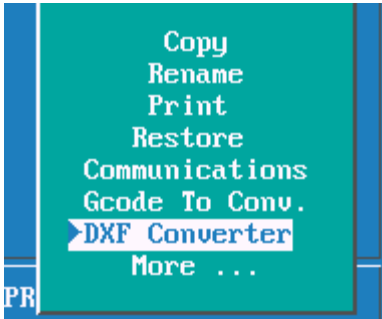
 **ENTER**

File name

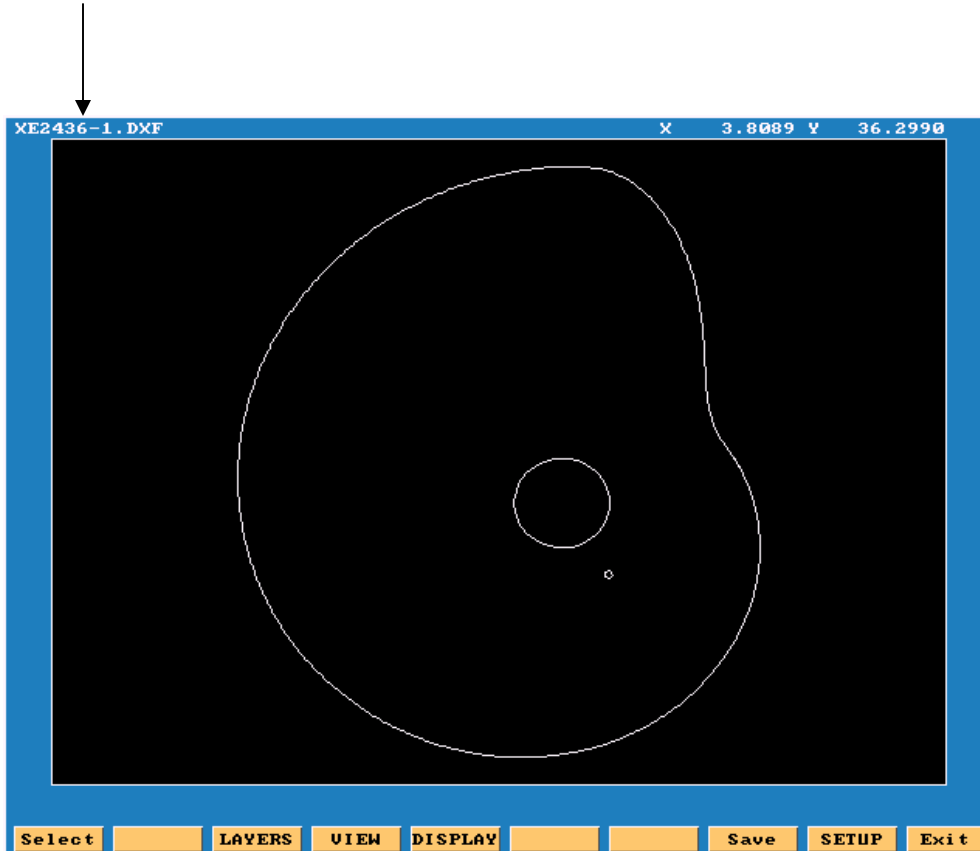

- Select:** Used when selecting elements on drawing.  
**Layers:** Allows layer on drawing to be turned Off or On.  
**View:** XY,XZ,YZ or isometric.  
**Display:**Fit, window, redraw, half or double.  
**Save:** Saves program with .G once converted.  
**Setup:** Allows setup of inputs and outputs.  
**Exit :** Goes back to **Program** page

Zero on most drawings is usually not at a point that is convenient for programming, so there is a way it can be changed.

In the case of current drawing, the center of the hole in center of part is the best point X0 Y0.

To do this Press the Ctrl key and hold it down put mouse point on to circle and press left mouse key, it will change to yellow, release keys.

At the bottom of screen X, Y, and Z coordinate will appear and also circle diameter.

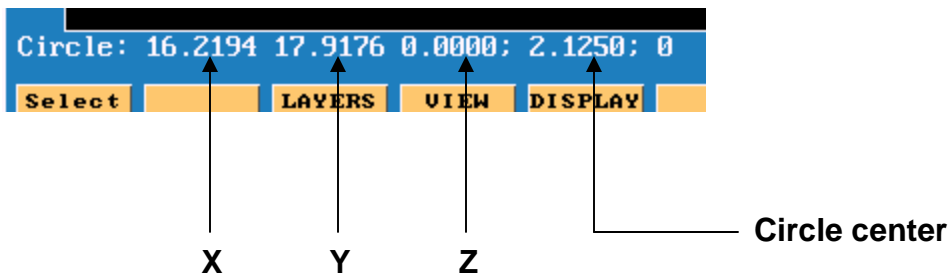

Now press **ALT** key and letter **T** at the same time. This will in put these coordinates in to the **SETUP** and change **X0 Y0** to the center of hole.

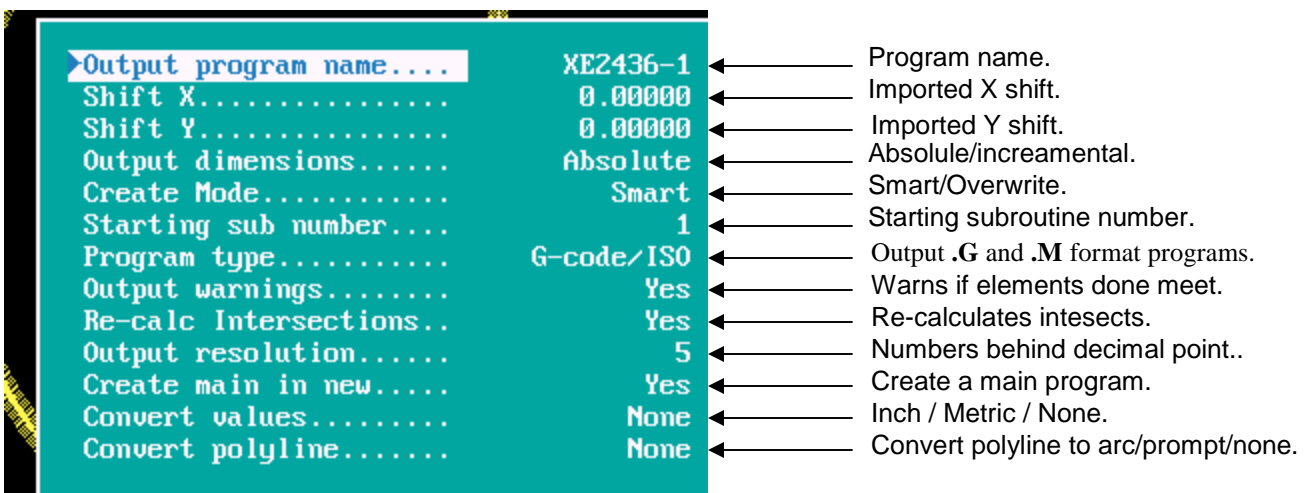

Press **F10** **Exit**

Press **ALT**key and letter **F**key at the same time, this will mark the end of each element.

Press **F5** **DISPLAY** high light **Window** press **ENTER** **Fit Window Redraw Half Double**

A box will appear on screen move around screen using

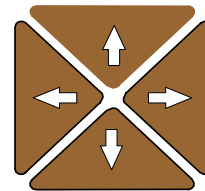

press **F6** **Compress** position box as shown below press **ENTER**

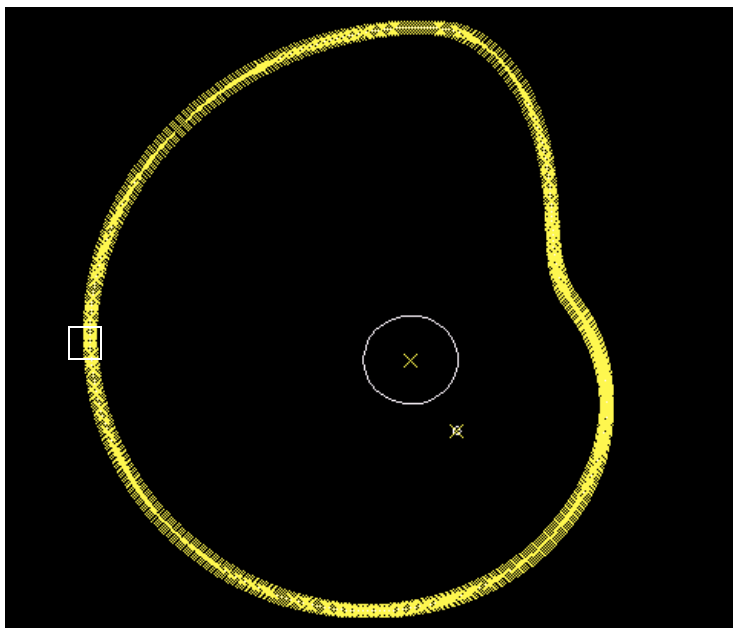



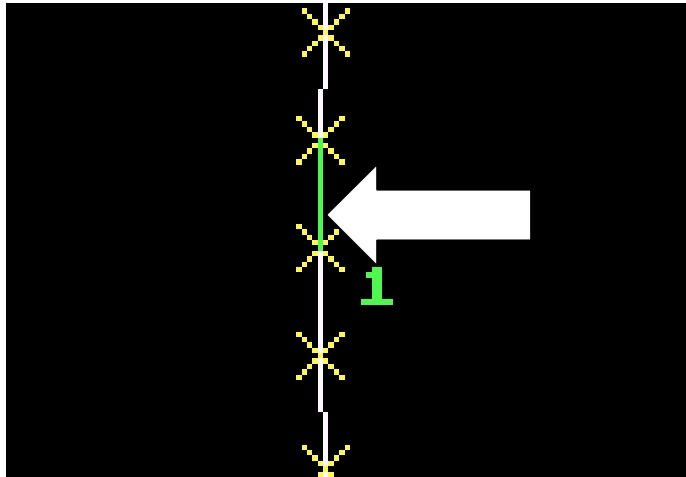

Press **F1** **Select** point mouse arrow to lower end of a line as shown and press left mouse key. Line will turn green as above and put a number at low end of line, the position of the number is the start point. Now point to the line below it and press left mouse key, all of the line will be come green.

Press **ALT** key and letter **F**key at the same time the end of line markers will disappear.

Press **F5** **DISPLAY** press **ENTER** Part will appear at full size on screen

Press **F8** **Save**



Press **F10** **Exit**



Press **F1** or Press **Y** **ENTER** it will now return to **Program page**.

High light **.G** or **.M** file press

**F4** **Edit**

High light **.M** file press

**F8**

**Edit**

in coversational will appear as below

```

1 Call 1
2 EndMain
3
4 Sub 1
5 Dim Abs
6 Rapid      X -14.44357 Y 1.05070
7 Line       X -14.44446 Y 1.17741
8 Line       X -14.44421 Y 1.30422
9 Line       X -14.44282 Y 1.43111
    
```

Start of program



```

719 Line     X -14.40565 Y 0.16721
720 Line     X -14.41445 Y 0.29298
721 Line     X -14.42213 Y 0.41891
722 Line     X -14.42868 Y 0.54500
723 Line     X -14.43410 Y 0.67123
724 Line     X -14.43839 Y 0.79760
725 Line     X -14.44155 Y 0.92409
726 Line     X -14.44357 Y 1.05070
727 EndSub
    
```

End of program

Program has to be **Edited** , to put in tool changes or cutter comp and **Z** moves.

High light **.G** file press

**F8**

**Edit**

in G code format will appear as below

```

M98 P1
M2

O1
G90 G0 X -14.44446 Y 1.17741
G1 X -14.44421 Y 1.30422
G1 X -14.44282 Y 1.43111
G1 X -14.44030 Y 1.55807
G1 X -14.43662 Y 1.68510
G1 X -14.43181 Y 1.81218
    
```



```

G1 X -14.41445 Y 0.29298
G1 X -14.42213 Y 0.41891
G1 X -14.42868 Y 0.54500
G1 X -14.43410 Y 0.67123
G1 X -14.43839 Y 0.79760
G1 X -14.44155 Y 0.92409
G1 X -14.44357 Y 1.05070
G1 X -14.44446 Y 1.17741
M99_
    
```

Program has to be **Edited** , to put in tool changes or cutter comp and **Z** moves.

This example will show multiple subroutines.

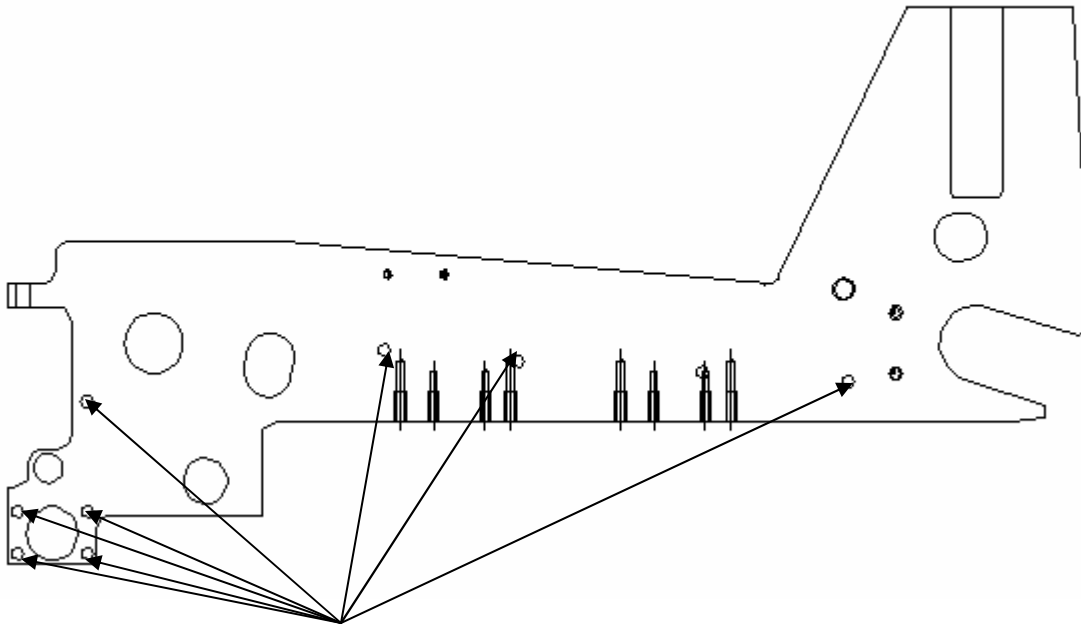

Press **F1** **Select** and pick all holes that are the same size , in this case 8. When going to second set of holes press right key on mouse.

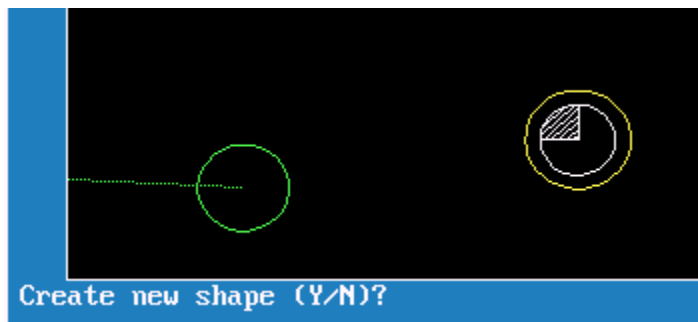

The green circle is the last of previously selected holes. The yellow circle is the one selected with right mouse button and in the bottom left it is asking if this is a new shape, the answer is **Y** .It will put a number 2 next to this hole, meaning this is shape 2.

The print below shows the four shapes of the different size holes.

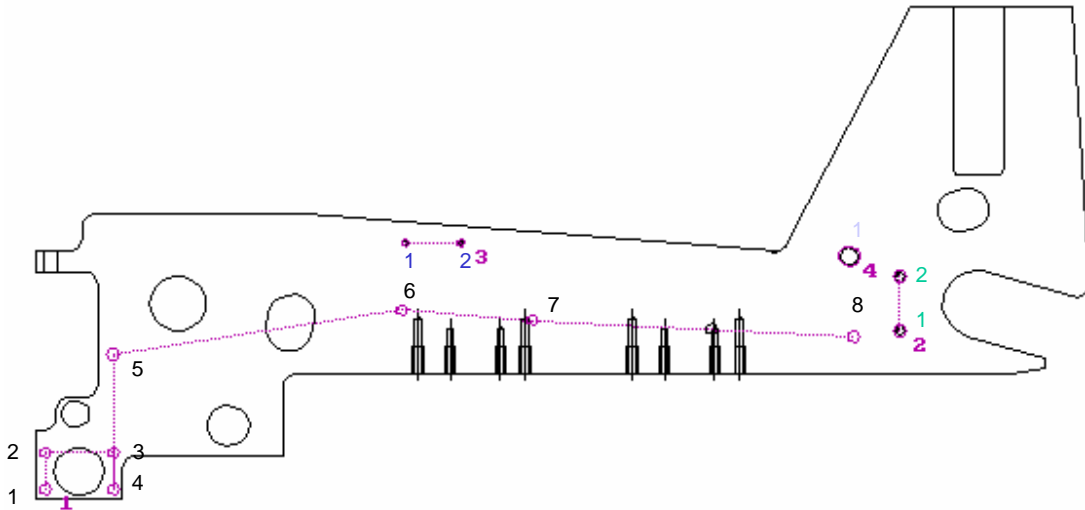

Press **F8** **Save**

Press **F10** **Exit**

Below is the output from the DXF converter.  
Some editing is required to put in drilling cycles.

```
M98 P1
M98 P2
M98 P3
M98 P4
M2

O1
G90 G0 X 0.15625 Y 0.84375
G0 X 0.15625 Y 0.15625
G0 X 1.34375 Y 0.15625
G0 X 1.34375 Y 0.84375
G0 X 1.34327 Y 2.66153
G0 X 6.38400 Y 3.50000
G0 X 14.30400 Y 3.00000
M99

O2
G90 G0 X 15.10019 Y 3.12200
G0 X 15.10019 Y 4.12200
M99

O3
G90 G0 X 7.42403 Y 4.75138
G0 X 6.45603 Y 4.75138
M99

O4
G90 G0 X 14.21138 Y 4.51231
M99
```

Subroutine calls

Subroutine for positions of the eight holes numbered in black.

Subroutine for positions of the two holes numbered in green.

Subroutine for positions of the two holes numbered in blue.

Subroutine for positions of the one hole numbered in blue.

The program below is Edited with the drill cycles in the program.

```
N1 G90 G70 G0 T0 Z0
N2 T1
N3 G81 Z-0.1500 R0.1000 F10.0
N4 M98 P1
N5 M98 P2
N6 M98 P3
N7 M98 P4
N8 G80
N9 G0 Z5
N10 T2
N11 G83 Z-0.5000 R0.1000 F12.0 I0.2500
N12 M98 P1
N13 G80
N14 G0 Z5
N15 T3
N16 G87 Z-1.0000 R0.1000 F12.0 I0.2500 J0.0200 K0.1500 W0.0100 U0.5000
N17 M98 P2
N18 G80
N19 G0 Z5
N20 T4
N21 G81 Z-0.2500 R0.1000 F15.0
N22 M98 P3
N23 G80
N23 G80
N24 G0 Z5
N25 T5
N26 G83 Z-1.0000 R0.1000 F8.0 I0.2500
N27 M98 P4
N28 G80
N29 G0 Z5
N30 M2
N31 O1
N32 G90 G0 X 0.15625 Y 0.84375
N33 G0 X 0.15625 Y 0.15625
N34 G0 X 1.34375 Y 0.15625
N35 G0 X 1.34375 Y 0.84375
N36 G0 X 1.34327 Y 2.66153
N37 G0 X 6.38400 Y 3.50000
N38 G0 X 14.30400 Y 3.00000
N39 M99
N40 O2
N41 G90 G0 X 15.10019 Y 3.12200
N42 G0 X 15.10019 Y 4.12200
N43 M99
N44 O3
N45 G90 G0 X 7.42403 Y 4.75138
N46 G0 X 6.45603 Y 4.75138
N47 M99
N48 O4
N49 G90 G0 X 14.21138 Y 4.51231
N50 M99
```

In this example of a full drawing and how to turn off unnecessary information ,such as dimensions etc.

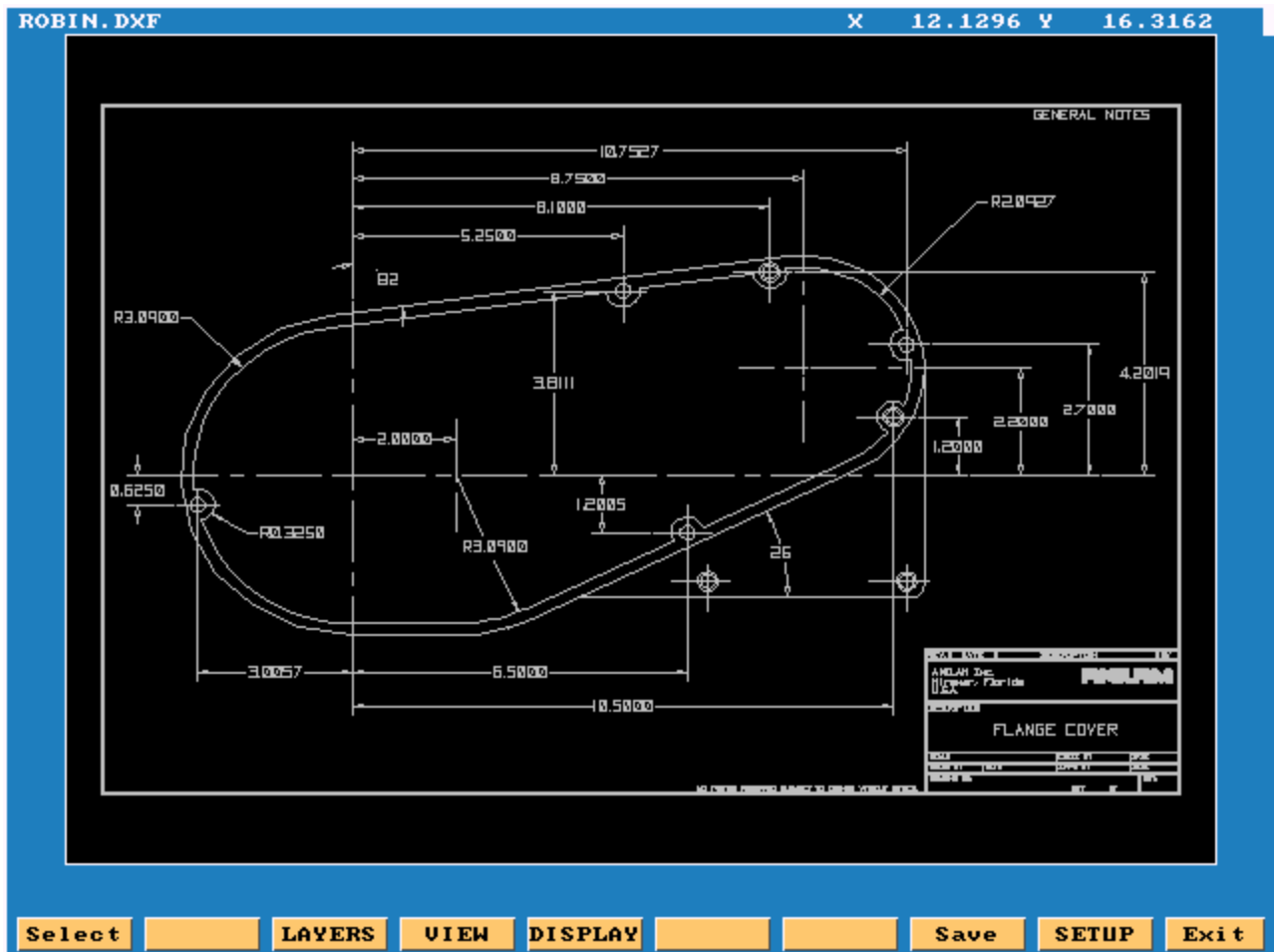



Press **F3** **Layers**

All Layers on  
Invert Layers  
Toggle Layers

High light **Toggle Layers** press

E  
N  
T  
E  
R

Put high light on layers not required and press

E  
N  
T  
E  
R

to turn OFF.



In the drawing shown the only layer required to be left on is #11

Only the part profiles and holes are left.

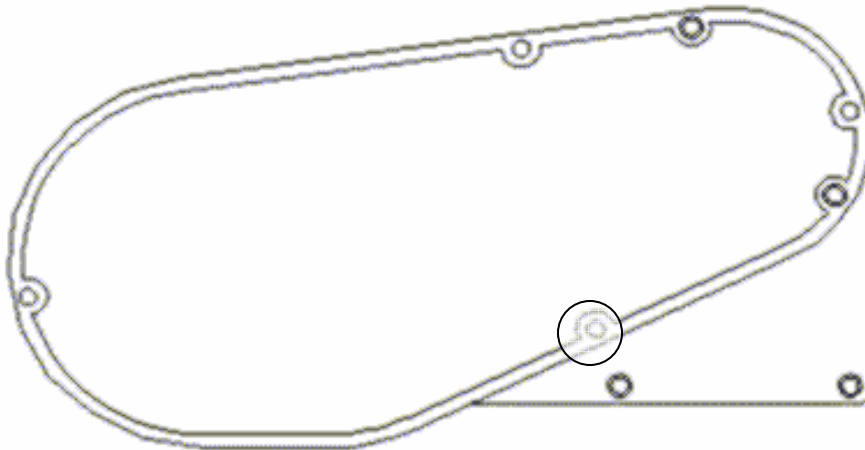

The circled area is blown up below. It shows an error in the drawing, where two lines are not connected. It will stop, select next element and the following message will appear.

Entity not connected. Connect anyway (Y/N)?

Press **Y** to continue.

It will then continue around part.

