

## ACER Group

Springwood Industrial, Inc.  
1062 N. Kraemer Place  
Anaheim, CA 92806  
Tel: 714-632-9701 Fax: 714-632-9730  
<http://www.acergroup.com>  
[info@acergroup.com](mailto:info@acergroup.com)

Klim Industrial, Inc.  
244 N. Randolphville Road  
Piscataway, NJ 08854  
Tel: 732-752-9100 Fax: 732-752-9101  
<http://www.acergroup.com>  
[acer\\_klim@yahoo.com](mailto:acer_klim@yahoo.com)

### PROCEDURE TO SETUP AGS 2040AHD SURFACE GRINDER

1. Unwrap the machine and check out machine for any physical damage. If so, report to your dealer as soon as possible. Touch-up paint is inside the toolbox. Use it as needed.
2. Turn vertical handwheel counterclockwise (spindle up) to take out spindle support block. Swing out control panel out when removing spindle support block.

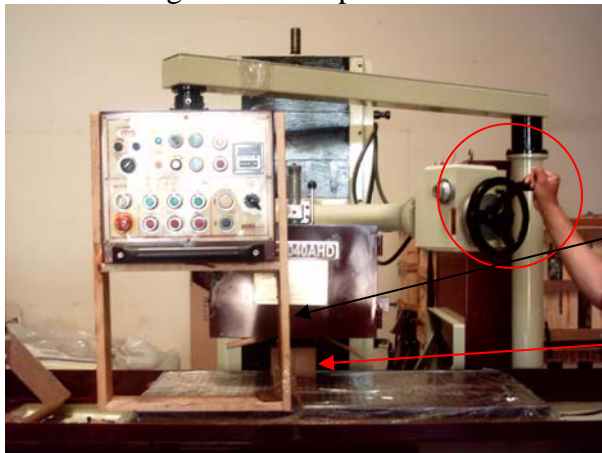

Control  
support

Spindle support  
block

3. Move machine to appropriate location. Put leveling screw, nut and pad on machine (follow picture)



Leveling screw,  
nut and pad

4. Remove the six brackets

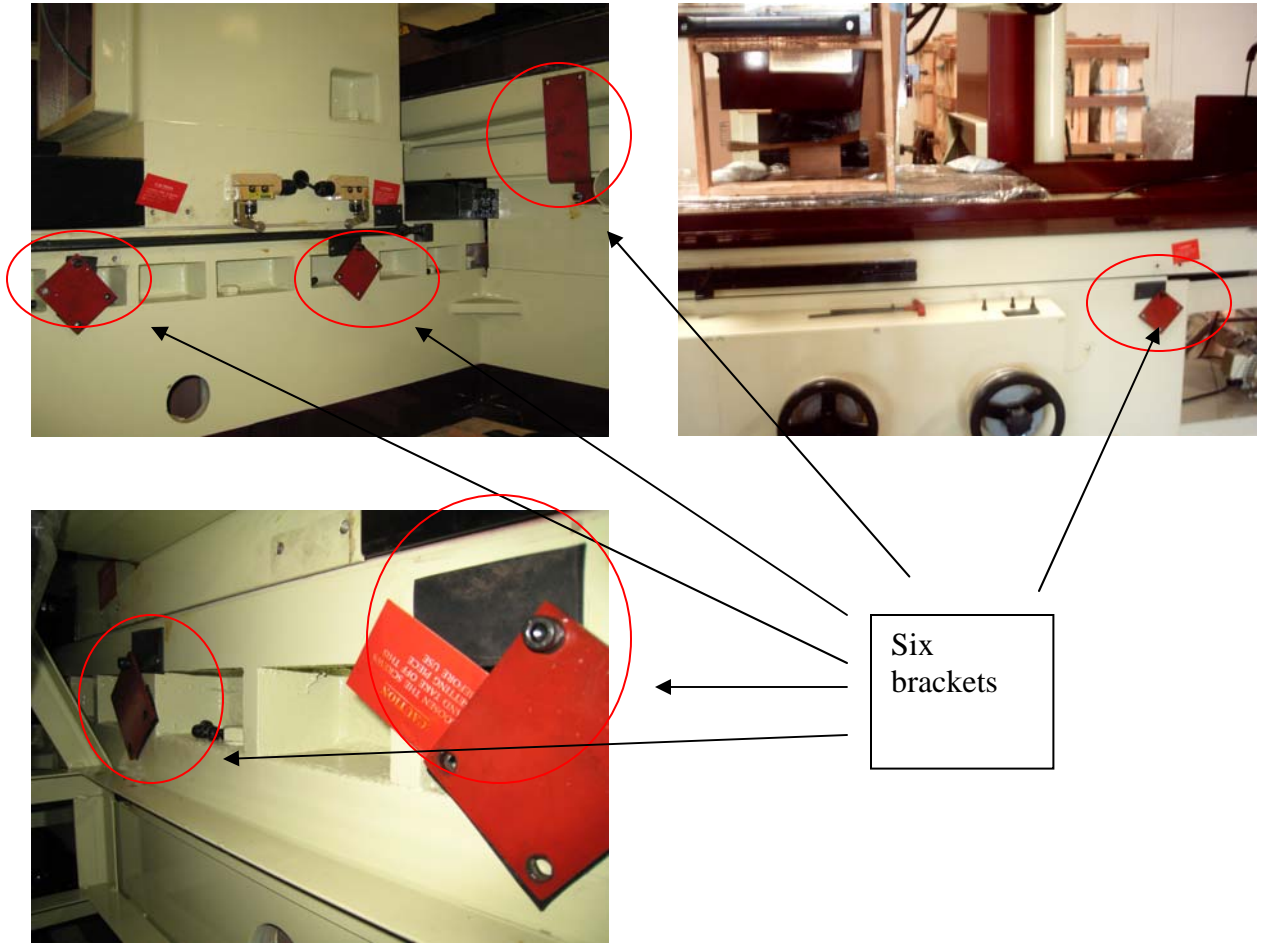

5. Place vertical screw cover on top of column

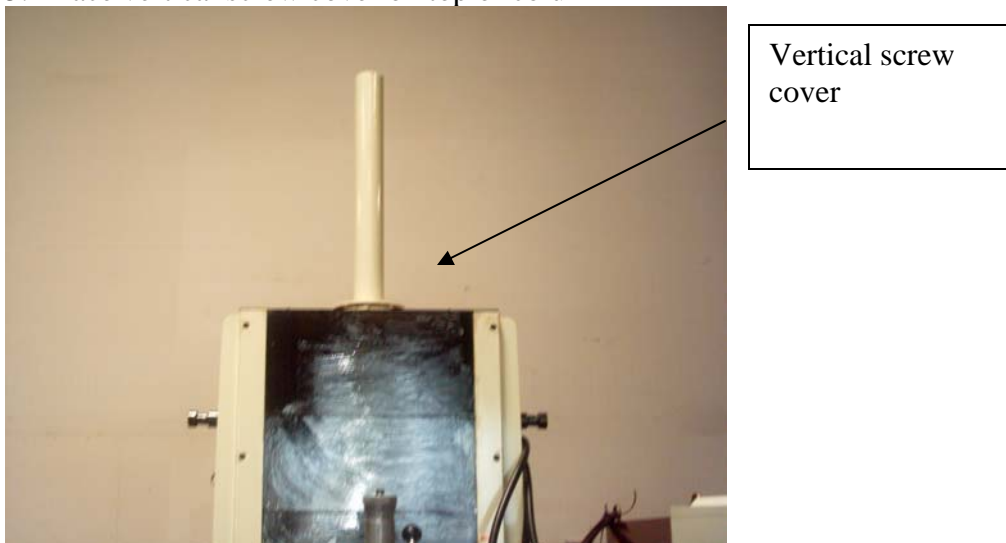

6. Check input power that will be used for the machine. Power required for our machines are: 230V three phase (3 $\Phi$ ) or 460V three phase (3 $\Phi$ ). Power must be first specified upon ordering. Please connect the power to R, S, T, Ground terminal as follows with minimum current of 45 amps (230V).

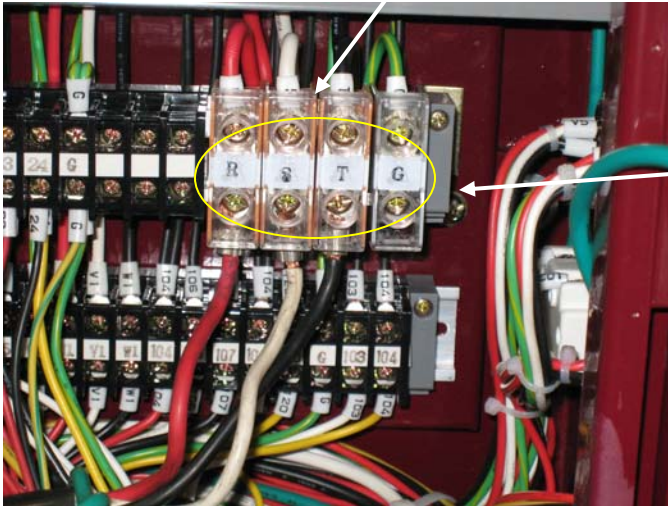
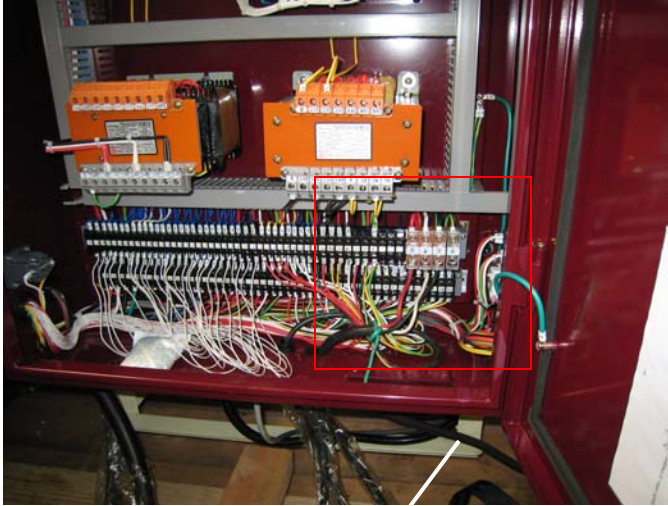

[R], [S], [T], [GROUND]



7. Hook up electronic conduct connectors, two from hydraulic system, one from magnetic separator and paper filter and one for the light.

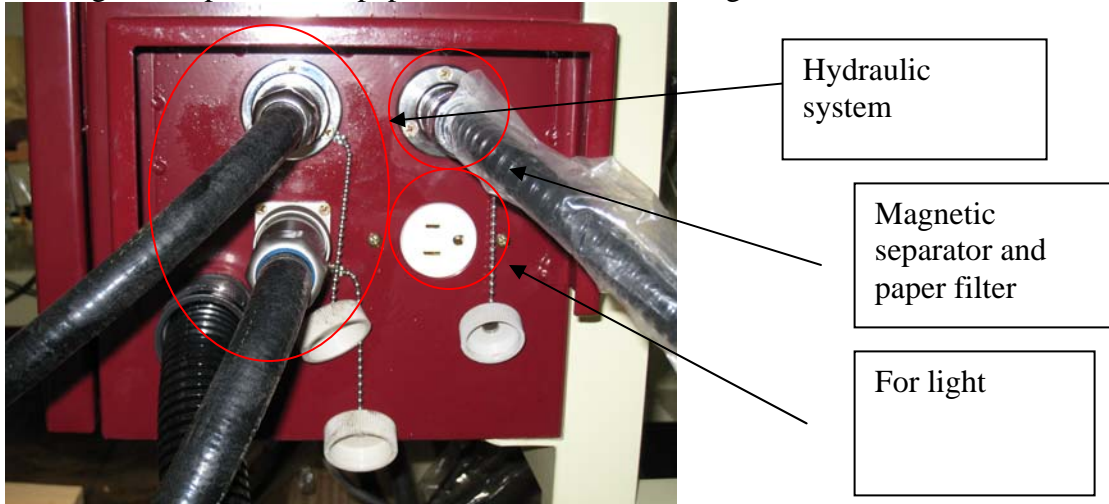

8. Connect five corresponding hydraulic hoses: A-A, B-B, C-C, and P-P, T-T as labeled.

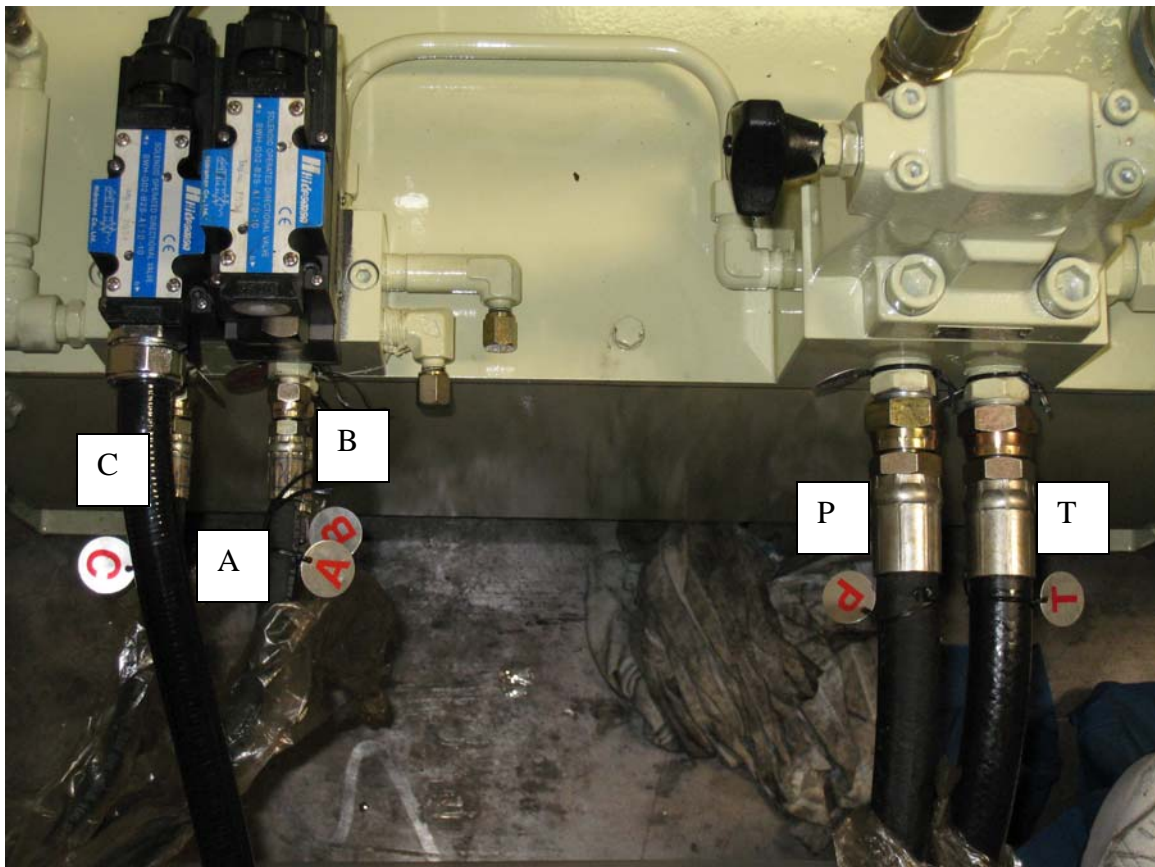

9. Fill up hydraulic oil (minimum 40 gallons) and lubricating oil . Make sure filling gauge is at F.

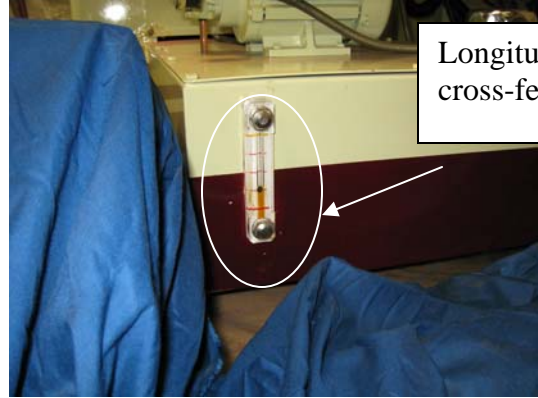

Longitudinal and cross-feed way tank

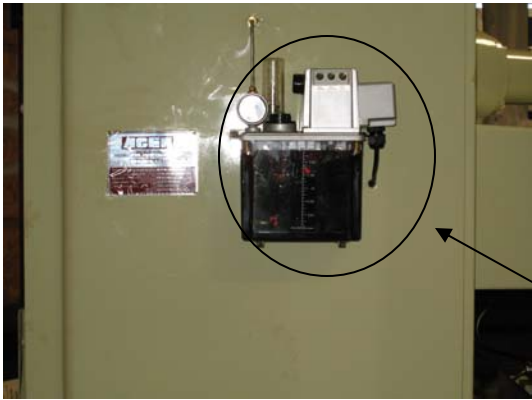

Hydraulic tank gauge

Vertical way lube

10. Turn on control. Make sure all the motors are running clockwise (spindle motor, hydraulic motor, cross-feed motor, vertical rapid motor, and coolant pump motor).
- 1) Release emergency button, turn on green start button. Turn chuck control on.
  - 2) Press spindle, hydraulic and magnetic separator and paper filter system buttons to check rotation.
  - 3) Check cross-feed motor by pressing in and out push button while function switch is in manual mode.
  - 4) Check rapid vertical motor by pressing up and down push buttons while function switch is in rapid mode.

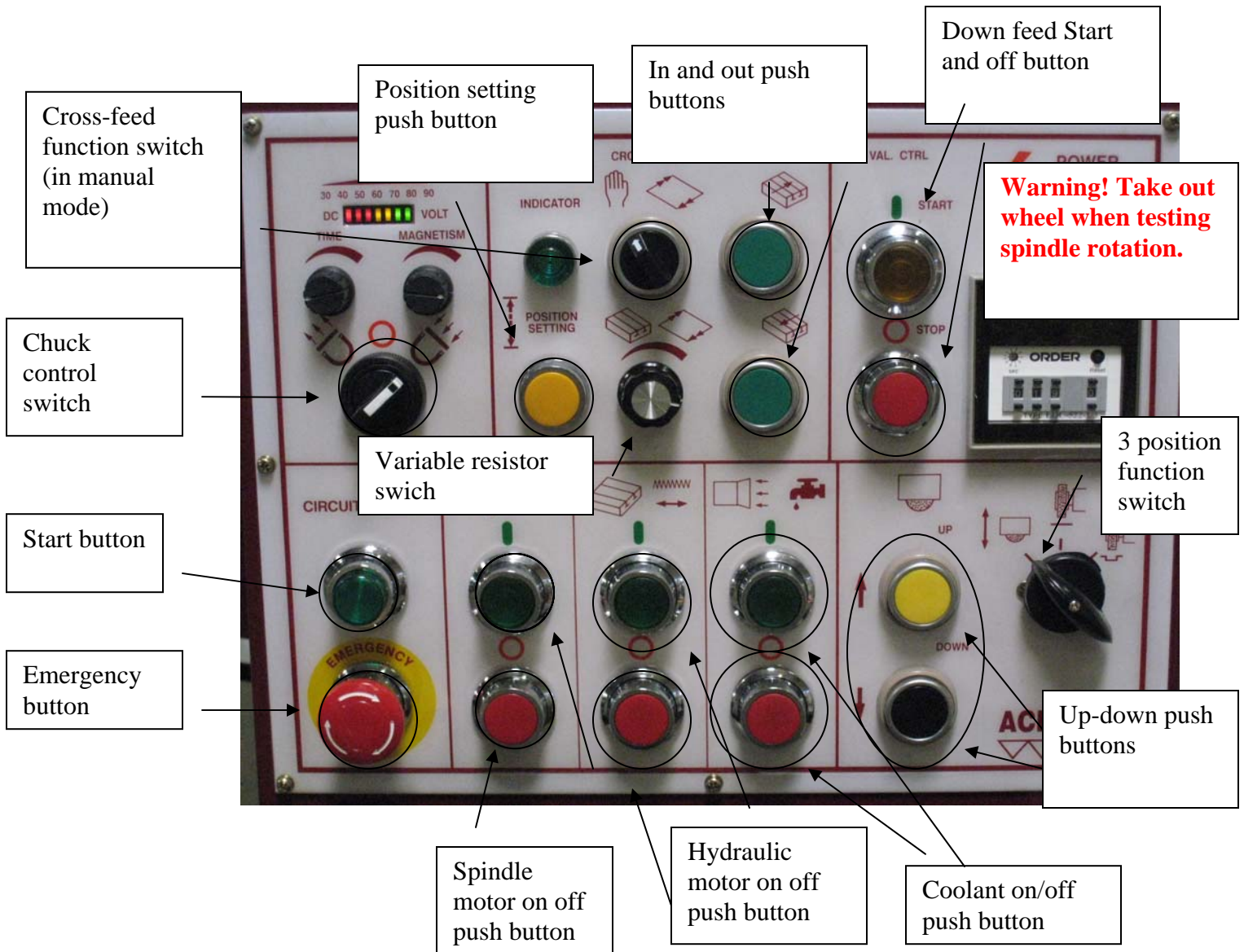

If opposite direction, please turn off main power by pushing emergency button. Switch any two power lines that go into the machine.

## 11. Leveling the machine

Precisely level the machine on a solid foundation. Precise leveling of the grinder is important to the finish of the product and the tolerance of the machine.

Machine level in X and Y axes has to be within .0004/12" or better.

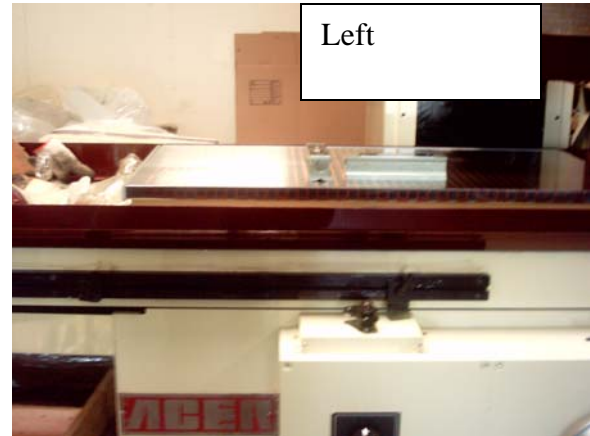

Step 1 (in center position)

Step 2

Move table to left hand side and check level again

Step 3

Move table to right hand side and check level

### (3). Levelling the machine

As following procedures:

1. Use longitudinal handwheel to let table at the middle position.

2. Levelling the machine by a Spirit Level in longitudinal and latitudinal position.

In this case, we suggest:

a. Screwing up the levelling bolts #1,3,4,7,8, and adjust machine's levelling by use bolts #2,5,6,9, only. ( Fig. A ).

b. After levelled, then drive table to the left end and adjust levelling bolts #1,7,8, ( Fig. B ).

c. Drive table to the right end and adjust levelling bolts #3,4, ( Fig. C,D )

d. Drive table back to the middle position and re-check.

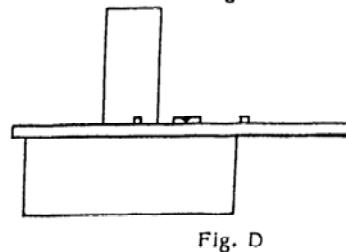
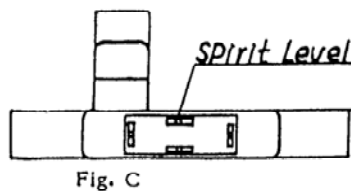
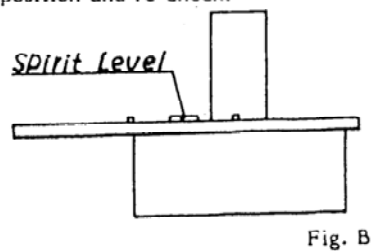
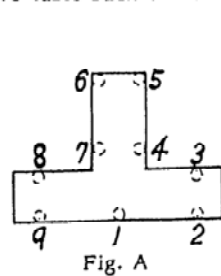

12. For auto lube pump, we recommend you use way oil #2 or for hydraulic oil, use Mobil DTE 25 or follow the manual suggestion.
13. Read through the operation manual and choose the correct wheel for application.
14. Ready to run your grinder: please read through the AGS 2040/60AHD manual to familiarize yourself with all functions, features and controls.
15. Should you have any questions or comments, please contact your local dealer first. They will then refer you to Acer 714-632-9701 (west coast) or 732-752-9100 (east coast) for further assistance.